

# Washer-Extractors

Cabinet Hardmount

S-Series Microcomputers

Refer to Page 3 for Model Identification

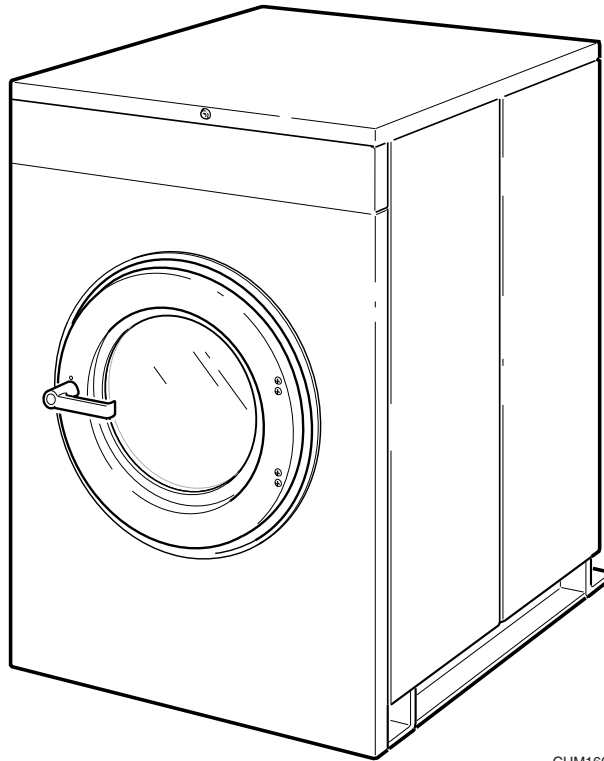

CHM166C

— Programming —

**Keep These Instructions for Future Reference.**

(If this machine changes ownership, this manual must accompany machine.)



[www.comlaundry.com](http://www.comlaundry.com)

Part No. F232139R3  
April 2008



# Table of Contents

<b>Introduction</b> .....	2
Model Identification .....	2
Nameplate Location.....	3
Replacement Parts .....	3
Customer Service.....	3
<b>Safety Information</b> .....	4
Important Safety Instructions .....	4
Safety Decals .....	6
Operator Safety .....	7
<b>Programming</b> .....	8
S-Series Microcomputers.....	8
Key Functions In Programming Mode .....	8
Cycle Count .....	8
Cycle Programming .....	8
Entering Program Mode.....	9
Programming Setup Options .....	9
Programming a Cycle .....	9
Armstrong S-Series Microcomputers .....	11
Programming Mode .....	11
Automatic Cool-Down.....	11
Enabling/Disabling Cool-Down.....	11
Cycle Segment Charts.....	12
Cycle Charts.....	14

© Copyright 2008, Alliance Laundry Systems LLC

All rights reserved. No part of the contents of this book may be reproduced or transmitted in any form or by any means without the expressed written consent of the publisher.

# Introduction

## Model Identification

Information in this manual is applicable to these models:

HC18SN2	HC60SN2	SC60SN2	UC40PN2
HC20SN2	HC80SN2	SC80SN2	UC50PN2
HC25SN2	SC18SN2	UC18PN2	UC60PN2
HC27SN2	SC25SN2	UC20PN2	UC60SN2
HC30SN2	SC27SN2	UC25PN2	UC80PN2
HC35SN2	SC35SN2	UC27PN2	
HC40SN2	SC50SN2	UC30PN2	
HC50SN2	SC60PN2	UC35PN2	

## Nameplate Location

The nameplate is located at the rear of the machine and inside door. Always provide the machine's serial number and model number when ordering parts or when seeking technical assistance.

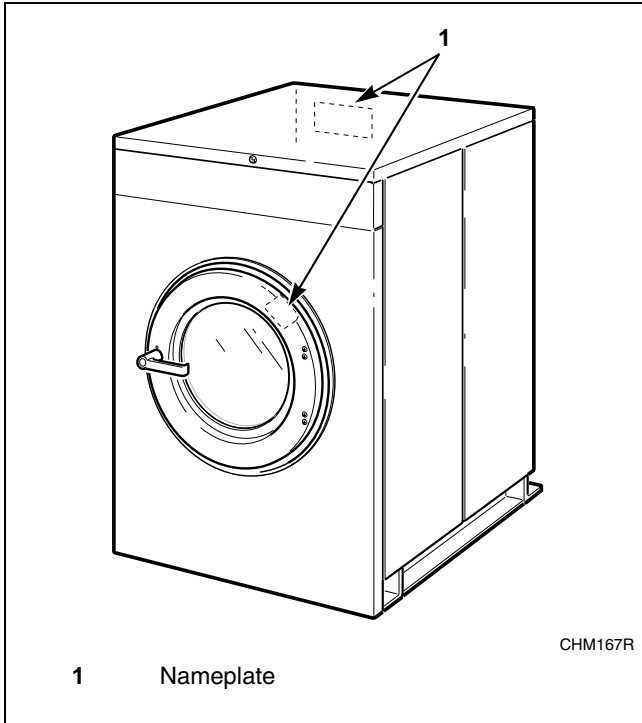

## Replacement Parts

If literature or replacement parts are required, contact the source from whom the machine was purchased or contact Alliance Laundry Systems LLC at (920) 748-3950 for the name and address of the nearest authorized parts distributor.

## Customer Service

For technical assistance, call any of the following numbers:

(920) 748-3121  
Ripon, Wisconsin U.S.A.

# Safety Information

Precautionary statements (“DANGER,” “WARNING” and “CAUTION”), followed by specific instructions, are found in this manual and on machine decals. These precautions are intended for the personal safety of the operator, user, servicer and those maintaining the machine.

	<b>DANGER</b>
<b>DANGER indicates the presence of a hazard that will cause severe personal injury, death, or substantial property damage if the danger is ignored.</b>	

	<b>WARNING</b>
<b>WARNING indicates the presence of a hazard that can cause severe personal injury, death, or substantial property damage if the warning is ignored.</b>	

	<b>CAUTION</b>
<b>CAUTION indicates the presence of a hazard that will or can cause minor personal injury or property damage if the caution is ignored.</b>	

Additional precautionary statements (“IMPORTANT” and “NOTE”) are followed by specific instructions.

**IMPORTANT:** The word “IMPORTANT” is used to inform the reader of specific procedures where minor machine damage will occur if the procedure is not followed.

**NOTE:** The word “NOTE” is used to communicate installation, operation, maintenance or servicing information that is important but not hazard related.

## Important Safety Instructions

	<b>WARNING</b>
<b>To reduce the risk of fire, electric shock, serious injury or death to persons when using your washer, follow these basic precautions:</b>	
W023	

1. Read all instructions before using the washer.
2. Refer to the GROUNDING INSTRUCTIONS in the INSTALLATION Manual for the proper grounding of the washer.
3. Do not wash textiles that have been previously cleaned in, washed in, soaked in, or spotted with gasoline, kerosene, waxes, cooking oils, dry-cleaning solvents, or other flammable or explosive substances as they give off vapors that could ignite or explode.
4. Do not add gasoline, dry-cleaning solvents, or other flammable or explosive substances to the wash water. These substances give off vapors that could ignite or explode.
5. Under certain conditions, hydrogen gas may be produced in a hot water system that has not been used for two weeks or more. **HYDROGEN GAS IS EXPLOSIVE.** If the hot water system has not been used for such a period, before using a washing machine or combination washer-dryer, turn on all hot water faucets and let the water flow from each for several minutes. This will release any accumulated hydrogen gas. The gas is flammable; do not smoke or use an open flame during this time.
6. Do not allow children to play on or in the washer. Close supervision of children is necessary when the washer is used near children. This is a safety rule for all appliances.
7. Before the washer is removed from service or discarded, remove the door to the washing compartment.
8. Do not reach into the washer if the wash drum is moving.

9. Do not install or store the washer where it will be exposed to water and/or weather.
10. Do not tamper with the controls.
11. Do not repair or replace any part of the washer, or attempt any servicing unless specifically recommended in the user-maintenance instructions or in published user-repair instructions that the user understands and has the skills to carry out.
12. To reduce the risk of an electric shock or fire, DO NOT use an extension cord or an adapter to connect the washer to the electrical power source.
13. Use washer only for its intended purpose, washing textiles.
14. Never wash machine parts or automotive parts in the machine. This could result in serious damage to the basket.
15. ALWAYS disconnect the washer from electrical supply before attempting any service. Disconnect the power cord by grasping the plug, not the cord.
16. Install the washer according to the INSTALLATION INSTRUCTIONS. All connections for water, drain, electrical power and grounding must comply with local codes and be made by licensed personnel when required.
17. To reduce the risk of fire, textiles which have traces of any flammable substances such as vegetable oil, cooking oil, machine oil, flammable chemicals, thinner, etc. or anything containing wax or chemicals such as in mops and cleaning cloths, must not be put into the washer. These flammable substances may cause the fabric to catch on fire by itself.
18. Do not use fabric softeners or products to eliminate static unless recommended by the manufacturer of the fabric softener or product.
19. Keep washer in good condition. Bumping or dropping the washer can damage safety features. If this occurs, have washer checked by a qualified service person.
20. If the supply cord is damaged, it must be replaced by a special cord or assembly available from the manufacturer or its service agent.
21. Be sure water connections have a shut-off valve and that fill hose connections are tight. CLOSE the shut-off valves at the end of each wash day.
22. Loading door MUST BE CLOSED any time the washer is to fill, tumble or spin. DO NOT bypass the loading door switch by permitting the washer to operate with the loading door open.
23. Always read and follow manufacturer's instructions on packages of laundry and cleaning aids. Heed all warnings or precautions. To reduce the risk of poisoning or chemical burns, keep them out of the reach of children at all times (preferably in a locked cabinet).
24. Always follow the fabric care instructions supplied by the textile manufacturer.
25. Never operate the washer with any guards and/or panels removed.
26. DO NOT operate the washer with missing or broken parts.
27. DO NOT bypass any safety devices.
28. Failure to install, maintain and/or operate this washer according to the manufacturer's instructions may result in conditions which can produce bodily injury and/or property damage.

**NOTE: The WARNINGS and IMPORTANT SAFETY INSTRUCTIONS appearing in this manual are not meant to cover all possible conditions and situations that may occur. Common sense, caution and care must be exercised when installing, maintaining or operating the washer.**

Any problems or conditions not understood should be reported to the dealer, distributor, service agent or the manufacturer.

	<b>WARNING</b>
<p>This machine must be installed, adjusted, and serviced by qualified electrical maintenance personnel familiar with the construction and operation of this type of machinery. They must also be familiar with the potential hazards involved. Failure to observe this warning may result in personal injury and/or equipment damage, and may void the warranty.</p>	
<small>SW004</small>	

**IMPORTANT:** Ensure that the recommended clearances for inspection and maintenance are provided. Never allow the inspection and maintenance space to be blocked.

	<b>WARNING</b>
<p>Install the machine on a level floor of sufficient strength. Failure to do so may result in conditions which can produce serious injury, death and/or property damage.</p>	
<small>W703</small>	

	<b>CAUTION</b>
<p>Be careful around the open door, particularly when loading from a level below the door. Impact with door edges can cause personal injury.</p>	
<small>SW025</small>	

	<b>WARNING</b>
<p>Never touch internal or external steam pipes, connections, or components. These surfaces can be extremely hot and will cause severe burns. The steam must be turned off and the pipe, connections, and components allowed to cool before the pipe can be touched.</p>	
<small>SW014</small>	

## Safety Decals

Safety decals appear at crucial locations on the machine. Failure to maintain legible safety decals could result in injury to the operator or service technician.

To provide personal safety and keep the machine in proper working order, follow all maintenance and safety procedures presented in this manual. If questions regarding safety arise, contact the manufacturer immediately.

Use manufacturer-authorized spare parts to avoid safety hazards.



## Operator Safety

	<b>WARNING</b>
<p><b>NEVER insert hands or objects into basket until it has completely stopped. Doing so could result in serious injury.</b></p> <p style="text-align: right;"><small>SW012</small></p>	

To ensure the safety of machine operators, the following maintenance checks must be performed daily:

1. Prior to operating the machine, verify that all warning signs are present and legible. Missing or illegible signs must be replaced immediately. Make certain that spares are available.
2. Check door interlock before starting operation of the machine:
  - a. Attempt to start the machine with the door open. The machine should not start with the door open.
  - b. Close the door without locking it and attempt to start the machine. The machine should not start with the door unlocked.
  - c. Close and lock the door and start a cycle. Attempt to open the door while the cycle is in progress. The door should not open.

If the door lock and interlock are not functioning properly, call a service technician.
3. Do not attempt to operate the machine if any of the following conditions are present:
  - a. The door does not remain securely locked during the entire cycle.
  - b. Excessively high water level is evident.
  - c. Machine is not connected to a properly grounded circuit.

Do not bypass any safety devices in the machine.

	<b>WARNING</b>
<p><b>Never operate the machine with a bypassed or disconnected balance system. Operating the machine with severe out-of-balance loads could result in personal injury and serious equipment damage.</b></p> <p style="text-align: right;"><small>SW039</small></p>	

# Programming

## S-Series Microcomputers

The computer board is inside the control module. Near the center of the board is a small toggle switch: this is the RUN/PROGRAM mode switch.

	<b>WARNING</b>
<p><b>Dangerous voltages are present in the electrical control box(es) and at the motor terminals. Only qualified personnel familiar with electrical test procedures, test equipment, and safety precautions should attempt adjustments and troubleshooting. Disconnect power from the machine before removing the control box cover, and before attempting any service procedures.</b></p>	
SW005	

The RUN/PROGRAM switch is normally in the up (RUN mode) position. To enter PROGRAM mode, flip the switch to the down position. The display will now show the current temperature in the sump.

Since the keypad operates in a slightly different fashion when in PROGRAM mode, pay careful attention to the programming instructions provided in this manual.

### Key Functions In Programming Mode

**Up** – The Up key is used to increase cycle numbers (1 through 30) and other numerical values such as times or temperatures (when creating wash formulas).

**Down** – The Down key is used to decrease cycle numbers (1 through 30) and other numerical values such as times or temperatures (when creating wash formulas).

**Start** – The Start key acts as an enter key in program mode. Use this key to enter data and move to the next function in the cycle.

**Stop** – The Stop key saves all data and terminates the programming procedure. If it is the first key pressed in PROGRAM mode, the computer enters SETUP mode. The Stop key can be pressed again to exit SETUP mode and return to PROGRAM mode.

## Cycle Count

To display the current cycle count, press the Start key while the display is showing the temperature in the sump. The display will show a 2-digit number indicating how many cycles have been run to completion (cycles which were stopped in progress are not counted). Press the Start key to return to PROGRAM mode without resetting the count. Press the Up or Down key to reset the count to zero and return to PROGRAM mode.

## Cycle Programming

To edit an existing cycle or create a new cycle, press the Up key while the display is showing the temperature in the sump. The display will show “CY01.” Press the Up or Down key until the desired cycle number is displayed. Press the Start key to begin editing the selected cycle.

All cycle programs (“CY01” – “CY30”) can be customized within a preset program structure. Each cycle program consists of eight program segments. Refer to *Table 1*.

Cycle Program Segments			
Segment	Display	Segment	Display
Prewash	PrE	Fill 3	FIL3
Wash	UASH	Fill 4	FIL4
Fill 1	FIL1	Fill 5	FIL5
Fill 2	FIL2	Fill 6	FIL6

Table 1

When modifying a cycle, a time must be entered for each segment. To skip a segment or spin, set the time to “00” and press the Start key.

## Entering Program Mode

1. Unlock and raise top cover.
2. Remove control module cover.
3. Locate the Run/Program Mode switch near center of computer board inside control module. Refer to *Figure 1*.

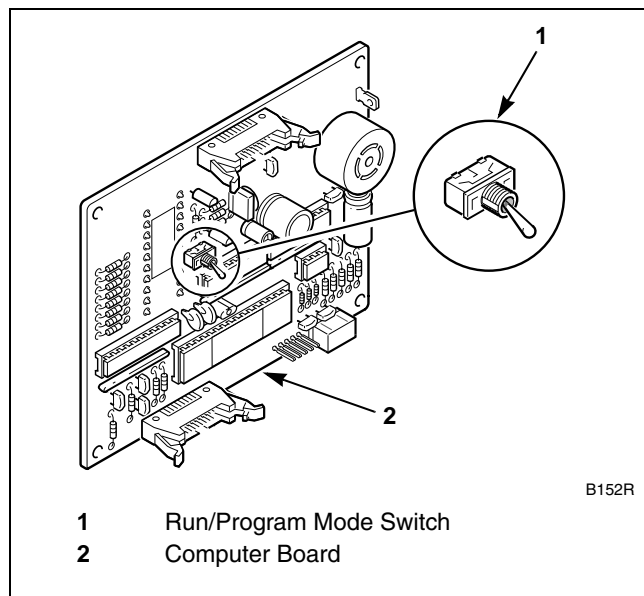

Figure 1

4. Flip switch to down position to enter Program Mode. Display will show current temperature of sump.

## Programming Setup Mode

**NOTE: Selection of degrees Fahrenheit or Celsius is only option for setup.**

1. Press Stop (\*) key to enter Setup Mode while display is showing temperature in sump.
2. Use Up or Down (arrow) key to change selected option. Press Start (#) key to accept selected option, either "FAR" or "CEL".
3. Press Stop (\*) key to exit Setup Mode.

## Programming a Cycle

1. Press Up (arrow) key until computer display shows segment to be edited. Press Start (#) key.
2. Use Up or Down (arrow) key to select desired segment time. Refer to *Table 2*. Set value to zero to skip segment. Press Start (#) key.

Time and Temperature Parameters		
Segment	Minimum	Maximum
PreWash	1 minute	30 minutes
Wash	2 minutes	20 minutes
Fill 1	2 minutes	15 minutes
Fill 2	2 minutes	15 minutes
Fill 3	2 minutes	15 minutes
Fill 4	2 minutes	15 minutes
Fill 5	2 minutes	15 minutes
Fill 6	2 minutes	15 minutes
Intermediate Spin	30 seconds	120 seconds
Final Spin	1 minute	10 minutes
Temperature	75°F (25°C)	200°F (93°C)

Table 2

**NOTE: Spin times in cycle segments 1 – 8 are entered in seconds (30 to 120), and time for final spin in segment 11 is entered in minutes (1 to 10).**

**NOTE: The computer does not count down the remaining cycle time during fills, drains, or prior to first achieving the programmed heat temperature when heating. The computer resumes counting down cycle time once the programmed fill level is reached, when the machine has drained, and after a programmed heat temperature is reached.**

	<b>WARNING</b>
<b>To avoid personal injury, recommended inlet water temperature should be no higher than 125° Fahrenheit (51° Celsius).</b>	
<small>W709</small>	

## Programming

- Use Up or Down (arrow) key to select fill temperature: cold (CFIL), hot (HFIL) or warm (bFIL). Press Start (#) key.
- Use Up or Down (arrow) key to select fill level: low level (LOLE) or high level (HILE). Press Start (#) key.
- Use Up or Down (arrow) key to select supply option. Refer to *Table 3*. Press Start (#) key.

Supply Options	
Display	Supply
SUP0	No Supply
SUP1	Supply 1
SUP2	Supply 2
SUP3	Supply 3
SUP4	Supply 4
SUP5	Supply 1 and 2
SUP6	Supply 2 and 3
SUP7	Supply 3 and 4

Table 3

The Supply Dispenser Compartment functions as follows: Supply compartment 1 flushes with each fill. Supply compartment 2 flushes when the program calls for supply 2 during a fill. Supply compartment 3 flushes when the program calls for supply 3 during a fill.

The Chemical Injection Supply Nozzles located in their respective supply compartments function as follows: Chemical supply nozzle 1 empties into compartment 1, chemical supply nozzle 2 and 4 empty into compartment 2, and chemical supply nozzle 3 empties into compartment 3. Refer to *Figure 2*.

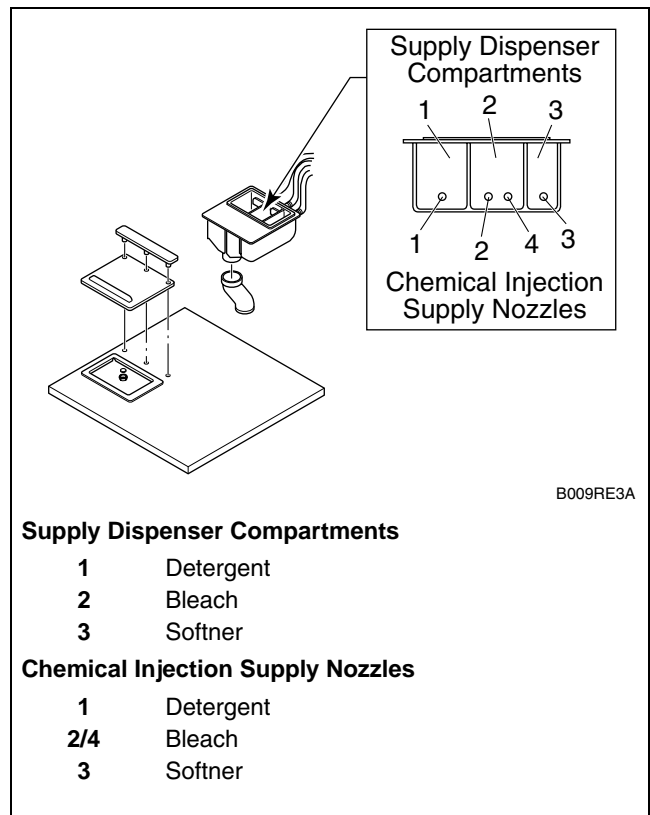

Figure 2

**NOTE: Compartment 2 does not flush when supply 4 is called for in a program.**

- If machine is equipped with auxiliary heating system, use Up or Down (arrow) key to select desired segment temperature. Set value to zero to disable auxiliary heat for this segment. Press Start (#) key.

**NOTE: Do not program heat steps for machines not equipped with auxiliary heat. The machine will pause for 30 minutes during any step in which the fill water temperature does not already equal or exceed the programmed value of the heat step.**

- Use Up or Down (arrow) key to select spin time. Set value to zero to skip spin step. Press Start (#) key. Display will now show the identifier for next program segment.
- Press the Stop (#) key to complete cycle programming procedure.

Refer to the *Cycle Charts* section for detailed description of cycles.

## Armstrong S-Series Microcomputers

**NOTE:** This section deals with machines that have the Armstrong S-series microcomputer only. When power is supplied to the machine, an Armstrong microcomputer will read “S 14”.

### Programming Mode

In the program mode, where the operator creates and changes cycle programs, some display messages have been changed. Refer to *Table 3*.

Previous software display	New software display
<b>PrE</b> (Prewash step)	<b>FIL1</b>
<b>PrEU</b> (Prewash, no “sluice” selected)	<b>FILL</b>
<b>SLUC</b> (Step contained a “sluice”)	<b>ovEr</b> (Overflow fill)*
<b>UASH</b> (Wash step)	<b>FIL2</b>
<b>FIL1</b>	<b>FIL3</b>
<b>FIL2</b>	<b>FIL4</b>
<b>FIL3</b>	<b>FIL5</b>
<b>drin</b> (“dilution rinse” no sluice)	<b>FILL</b>
<b>FIL4</b>	<b>FIL6</b>
<b>FIL5</b>	<b>FIL7</b>
<b>FIL6</b>	<b>FIL8</b>

Table 4

**\*NOTE:** Because the COLD water valve might remain energized for some time, it is necessary to ensure that the machine has a suitable overflow connection.

### Automatic Cool-Down

**NOTE:** Can be disabled.

The automatic cool-down feature prevents the drain from opening until the temperature of the water in the sump falls below 140°F (60°C).

This feature becomes active during a drain step, if the step is programmed for “drAI” when the temperature is above the threshold temperature. During the cool-down, the COLD fill valve is energized, the drain remains closed and the machine continues to agitate as it did prior to the cool-down. When the temperature falls below 140°F (60°C), the COLD fill valve turns off and the drain step proceeds as normal.

### Enabling/Disabling Cool-Down

**NOTE:** Factory default is disabled.

To enable or disable the cool-down feature, first enter Program Mode, refer to page 7, then proceed as follows:

1. After entering Program Mode display shows temperature. Press Stop (\*) key.
2. Display shows “°CEL”. Press Start (#) key.
3. Display shows “HEAt”. Press Start (#) key.
4. Display shows “Cool” if cool-down is enabled or “noCL” if disabled. To change this, press Up or Down (arrow) key.
5. Press Start (#) key to save and return to Program Mode.

## Programming

### Cycle Segment Charts

<b>Segment 1 (Prewash)</b>	
<b>Display</b>	<b>Instructions</b>
Use the Up or Down key to change. Press the Start key to enter or advance.	
PrE	
00 or 02 to 30	Select segment time: 02 to 30 minutes (00 to skip segment)
HFIL, CFIL, or bFIL	Select “HFIL” (hot fill), “CFIL” (cold fill), or “bFIL” (warm fill)
LOLE or HILE	Select fill level: “LOLE” (low), or “HILE” (high) water level
SUP0–SUP7	Select supply 0 – 7 (0 for no supply)
00°F, 75°F–200°F 00°C, 25°C–93°C	Select temperature: 75 to 200°F or 25 to 93°C (00 for no heat)
SPIn (flashed for one second)	
tINE (flashed for one second)	
00 or 30 to 120	Select time for spin: 30 to 120 seconds (00 for no spin)

<b>Segment 2 (Wash)</b>	
<b>Display</b>	<b>Instructions</b>
Use the Up or Down key to change. Press the Start key to enter or advance.	
UASH	
00 or 02 to 20	Select segment time: 02 to 20 minutes (00 to skip segment)
HFIL, CFIL, or bFIL	Select “HFIL” (hot fill), “CFIL” (cold fill), or “bFIL” (warm fill)
LOLE or HILE	Select fill level: “LOLE” (low), or “HILE” (high) water level
SUP0–SUP7	Select supply 0–7 (0 for no supply)
00°F, 75°F–200°F 00°C, 25°C–93°C	Select temperature: 75 to 200°F or 25 to 93°C (00 for no heat)
SPIn (flashed for one second)	
tINE (flashed for one second)	
00 or 30 to 120	Select time for spin: 30 to 120 seconds (00 for no spin)

## Cycle Segment Charts (Continued)

<b>Segments 3 – 7 (Fills 1 – 5)</b>	
<b>Display</b>	<b>Instructions</b>
Use the Up or Down key to change. Press the Start key to enter or advance.	
FIL1, FIL2, FIL3, FIL4, or FIL5	
00 or 02 to 15	Select segment time: 02 to 15 minutes (00 to skip segment)
HFIL, CFIL, or bFIL	Select “HFIL” (hot fill), “CFIL” (cold fill), or “bFIL” (warm fill)
LOLE or HILE	Select fill level: “LOLE” (low), or “HILE” (high) water level
SUP0–SUP7	Select supply 0 – 7 (0 for no supply)
00°F, 75°F–200°F 00°C, 25°C–93°C	Select temperature: 75 to 200°F or 25 to 93°C (00 for no heat)
SPIn (flashed for one second)	
tINE (flashed for one second)	
00 or 30 to 120	Select time for spin: 30 to 120 seconds (00 for no spin)
<b>Segment 8 (Fill 6)</b>	
<b>Display</b>	<b>Instructions</b>
Use the Up or Down key to change. Press the Start key to enter or advance.	
FIL6	
00 or 02 to 15	Select segment time: 02 to 15 minutes (00 to skip segment)
HFIL, CFIL, or bFIL	Select “HFIL” (hot fill), “CFIL” (cold fill), or “bFIL” (warm fill)
LOLE or HILE	Select fill level: “LOLE” (low), or “HILE” (high) water level
SUP0–SUP7	Select supply 0 – 7 (0 for no supply)
00°F, 75°F–200°F 00°C, 25°C–93°C	Select temperature: 75 to 200°F or 25 to 93°C (00 for no heat)
SPIn (flashed for one second)	
tINE (flashed for one second)	
00 or 01 to 10	Select time for spin: 1 to 10 minutes (00 for no spin)

## Programming

### Cycle Charts

<b>S-Series Microcomputers Standard Cycles</b>						
<b>Cycle Program</b>	<b>1 Light Soil Whites</b>	<b>2 Light Soil Colors</b>	<b>3 Medium Soil Whites</b>	<b>4 Medium Soil Colors</b>	<b>5 Heavy Soil Whites</b>	<b>6 Heavy Soil Colors</b>
<b>PreWash</b>						
Time (Min.)	0	0	0	2	2	2
Water	---	---	---	Cold	Hot	Cold
Level	---	---	---	High	High	High
Supply	---	---	---	0	0	0
Temp (F)	---	---	---	0	0	0
Spin (Sec.)	---	---	---	0	0	0
<b>Wash</b>						
Time (Min.)	6	6	7	7	5	5
Water	Hot	Warm	Hot	Warm	Hot	Warm
Level	Low	Low	Low	Low	Low	Low
Supply	5	1	1	1	1	1
Temp (F)	0	0	0	0	0	0
Spin (Sec.)	40	40	60	60	60	60
<b>Fill 1</b>						
Time (Min.)	0	0	5	2	5	5
Water	---	---	Hot	Warm	Hot	Warm
Level	---	---	Low	High	Low	Low
Supply	---	---	2	0	1	1
Temp (F)	---	---	0	0	0	0
Spin (Sec.)	---	---	60	40	0	60
<b>Fill 2</b>						
Time (Min.)	0	0	2	0	6	3
Water	---	---	Warm	---	Hot	Warm
Level	---	---	High	---	Low	High
Supply	---	---	0	---	2	0
Temp (F)	---	---	0	---	0	0
Spin (Sec.)	---	---	40	---	60	0
<b>Fill 3</b>						
Time (Min.)	0	0	0	0	2	0
Water	---	---	---	---	Hot	---
Level	---	---	---	---	High	---
Supply	---	---	---	---	0	---
Temp (F)	---	---	---	---	0	---
Spin (Sec.)	---	---	---	---	60	---
<b>Fill 4</b>						
Time (Min.)	0	0	0	0	2	0
Water	---	---	---	---	Hot	---
Level	---	---	---	---	High	---
Supply	---	---	---	---	0	---
Temp (F)	---	---	---	---	0	---
Spin (Sec.)	---	---	---	---	0	---



<b>S-Series Microcomputers Standard Cycles (Continued)</b>						
<b>Cycle Program</b>	<b>1 Light Soil Whites</b>	<b>2 Light Soil Colors</b>	<b>3 Medium Soil Whites</b>	<b>4 Medium Soil Colors</b>	<b>5 Heavy Soil Whites</b>	<b>6 Heavy Soil Colors</b>
<b>Fill 5</b>						
Time (Min.)	3	3	2	2	3	3
Water	Warm	Warm	Warm	Warm	Warm	Warm
Level	High	High	High	High	High	High
Supply	0	0	0	0	0	0
Temp (F)	0	0	0	0	0	0
Spin (Sec.)	0	0	0	0	0	0
<b>Fill 6</b>						
Time (Min.)	3	3	3	3	3	3
Water	Warm	Warm	Warm	Warm	Warm	Warm
Level	High	High	High	High	High	High
Supply	3	3	3	3	3	3
Temp (F)	0	0	0	0	0	0
Spin (Min.)	5	4	5	4	5	4

## Programming

<b>S-Series Microcomputers Standard Cycles (Continued)</b>						
<b>Cycle Program</b>	<b>7 Permanent Press Visa</b>	<b>8 Gentle Delicate Wool</b>	<b>9 ReWash Destaining</b>	<b>10 Heavy Soil</b>	<b>11 Rinse Spin</b>	<b>12 Personals Starch</b>
<b>PreWash</b>						
Time (Min.)	2	2	3	3	0	6
Water	Cold	Cold	Warm	Warm	---	Warm
Level	High	High	High	High	---	Low
Supply	0	0	1	0	---	1
Temp (F)	0	0	0	0	---	0
Spin (Sec.)	0	0	0	0	---	0
<b>Wash</b>						
Time (Min.)	2	6	8	6	0	5
Water	Warm	Cold	Hot	Hot	---	Hot
Level	High	Low	Low	Low	---	Low
Supply	0	1	5	1	---	1
Temp (F)	0	0	0	0	---	0
Spin (Sec.)	0	60	0	60	---	60
<b>Fill 1</b>						
Time (Min.)	6	2	6	5	0	3
Water	Warm	Cold	Hot	Hot	---	Hot
Level	Low	High	High	Low	---	High
Supply	1	0	2	1	---	0
Temp (F)	0	0	0	0	---	0
Spin (Sec.)	30	0	60	60	---	60
<b>Fill 2</b>						
Time (Min.)	3	0	3	6	0	0
Water	Warm	---	Warm	Hot	---	---
Level	High	---	High	Low	---	---
Supply	0	---	0	2	---	---
Temp (F)	0	---	0	0	---	---
Spin (Sec.)	0	---	60	60	---	---
<b>Fill 3</b>						
Time (Min.)	2	0	0	3	0	0
Water	Warm	---	---	Hot	---	---
Level	High	---	---	High	---	---
Supply	0	---	---	0	---	---
Temp (F)	0	---	---	0	---	---
Spin (Sec.)	0	---	---	0	---	---
<b>Fill 4</b>						
Time (Min.)	0	0	0	0	0	0
Water	---	---	---	---	---	---
Level	---	---	---	---	---	---
Supply	---	---	---	---	---	---
Temp (F)	---	---	---	---	---	---
Spin (Sec.)	---	---	---	---	---	---

<b>S-Series Microcomputers Standard Cycles (Continued)</b>						
<b>Cycle Program</b>	<b>7 Permanent Press Visa</b>	<b>8 Gentle Delicate Wool</b>	<b>9 ReWash Destaining</b>	<b>10 Heavy Soil</b>	<b>11 Rinse Spin</b>	<b>12 Personals Starch</b>
<b>Fill 5</b>						
Time (Min.)	3	0	3	3	0	2
Water	Cold	---	Warm	Warm	---	Warm
Level	High	---	High	High	---	High
Supply	3	---	0	0	---	0
Temp (F)	0	---	0	0	---	0
Spin (Sec.)	40	---	0	0	---	0
<b>Fill 6</b>						
Time (Min.)	0	3	3	3	2	4
Water	---	Cold	Warm	Warm	Warm	Warm
Level	---	High	High	High	Low	High
Supply	---	3	3	3	0	4
Temp (F)	---	0	0	0	0	0
Spin (Min.)	---	3	5	5	2	4

## Programming

S-Series Microcomputers Cycles						
Cycle Program	13 Test Cycle 1	14 Test Cycle 2	15	16	17	18
<b>PreWash</b>						
Time (Min.)	0	0	0			
Water	---	---	---			
Level	---	---	---			
Supply	---	---	---			
Temp (F)	---	---	---			
Spin (Sec.)	---	---	---			
<b>Wash</b>						
Time (Min.)	3	3	0			
Water	Warm	Warm	---			
Level	High	High	---			
Supply	1	1	---			
Temp (F)	0	80	---			
Spin (Sec.)	0	0	---			
<b>Fill 1</b>						
Time (Min.)	0	0	0			
Water	---	---	---			
Level	---	---	---			
Supply	---	---	---			
Temp (F)	---	---	---			
Spin (Sec.)	---	---	---			
<b>Fill 2</b>						
Time (Min.)	0	0	0			
Water	---	---	---			
Level	---	---	---			
Supply	---	---	---			
Temp (F)	---	---	---			
Spin (Sec.)	---	---	---			
<b>Fill 3</b>						
Time (Min.)	0	0	0			
Water	---	---	---			
Level	---	---	---			
Supply	---	---	---			
Temp (F)	---	---	---			
Spin (Sec.)	---	---	---			
<b>Fill 4</b>						
Time (Min.)	0	0	0			
Water	---	---	---			
Level	---	---	---			
Supply	---	---	---			
Temp (F)	---	---	---			
Spin (Sec.)	---	---	---			

S-Series Microcomputers Cycles (Continued)						
Cycle Program	13 Test Cycle 1	14 Test Cycle 2	15	16	17	18
<b>Fill 5</b>						
Time (Min.)	2	2				
Water	Cold	Cold				
Level	Low	Low				
Supply	2	2				
Temp (F)	0	0				
Spin (Sec.)	0	0				
<b>Fill 6</b>						
Time (Min.)	2	2				
Water	Hot	Hot				
Level	Low	Low				
Supply	3	3				
Temp (F)	0	0				
Spin (Sec.)	3	3				

**Programming**

<b>S-Series Microcomputers Blank Cycles</b>						
<b>Cycle Program</b>	<b>19</b>	<b>20</b>	<b>21</b>	<b>22</b>	<b>23</b>	<b>24</b>
<b>PreWash</b>						
Time (Min.)						
Water						
Level						
Supply						
Temp (F)						
Spin (Sec.)						
<b>Wash</b>						
Time (Min.)						
Water						
Level						
Supply						
Temp (F)						
Spin (Sec.)						
<b>Fill 1</b>						
Time (Min.)						
Water						
Level						
Supply						
Temp (F)						
Spin (Sec.)						
<b>Fill 2</b>						
Time (Min.)						
Water						
Level						
Supply						
Temp (F)						
Spin (Sec.)						
<b>Fill 3</b>						
Time (Min.)						
Water						
Level						
Supply						
Temp (F)						
Spin (Sec.)						
<b>Fill 4</b>						
Time (Min.)						
Water						
Level						
Supply						
Temp (F)						
Spin (Sec.)						

S-Series Microcomputers Blank Cycles (Continued)						
Cycle Program	19	20	21	22	23	24
<b>Fill 5</b>						
Time (Min.)						
Water						
Level						
Supply						
Temp (F)						
Spin (Sec.)						
<b>Fill 6</b>						
Time (Min.)						
Water						
Level						
Supply						
Temp (F)						
Spin (Sec.)						

**Programming**

<b>S-Series Microcomputers Blank Cycles (Continued)</b>						
<b>Cycle Program</b>	<b>25</b>	<b>26</b>	<b>27</b>	<b>28</b>	<b>29</b>	<b>30</b>
<b>PreWash</b>						
Time (Min.)						
Water						
Level						
Supply						
Temp (F)						
Spin (Sec.)						
<b>Wash</b>						
Time (Min.)						
Water						
Level						
Supply						
Temp (F)						
Spin (Sec.)						
<b>Fill 1</b>						
Time (Min.)						
Water						
Level						
Supply						
Temp (F)						
Spin (Sec.)						
<b>Fill 2</b>						
Time (Min.)						
Water						
Level						
Supply						
Temp (F)						
Spin (Sec.)						
<b>Fill 3</b>						
Time (Min.)						
Water						
Level						
Supply						
Temp (F)						
Spin (Sec.)						
<b>Fill 4</b>						
Time (Min.)						
Water						
Level						
Supply						
Temp (F)						
Spin (Sec.)						



S-Series Microcomputers Blank Cycles (Continued)						
Cycle Program	25	26	27	28	29	30
<b>Fill 5</b>						
Time (Min.)						
Water						
Level						
Supply						
Temp (F)						
Spin (Sec.)						
<b>Fill 6</b>						
Time (Min.)						
Water						
Level						
Supply						
Temp (F)						
Spin (Sec.)						

# Programming

Armstrong S-Series Microcomputers Cycles									
Cycle Program	1 Very Hot 90°C	2 Hot Medical 85°C Sluice	3 Medical 71°C Sluice	4 Warm 60°C	5 Cool 40°C	6 Rinse and Spin	7-10	11 Warm Gentle 60°C Sluice	12 Cool Gentle 40°C
<b>Fill 1</b>							C U S T O M E R  R E Q U E S T E D  P R O G R A M S		
Fill/over	Fill	Fill	Fill	Fill	Fill	Fill		Fill	Fill
Time (Min.)	0	2	2	0	0	0		2	0
Water	---	Cold	Cold	---	---	---		Cold	---
Level	---	High	High	---	---	---		High	---
Supply	---	S0	S0	---	---	---		S0	---
Temp (C)	---	0	0	---	---	---		0	---
Drain	---	Drai	Drai	---	---	---		Drai	---
Spin (Sec.)	---	0	0	---	---	---		0	---
<b>Fill 2</b>									
Time (Min.)	0	2	2	0	0	0		2	0
Water	---	Cold	Cold	---	---	---		Cold	---
Level	---	High	High	---	---	---		High	---
Supply	---	S0	S0	---	---	---		S0	---
Temp (C)	---	0	0	---	---	---		0	---
Drain	---	Drai	Drai	---	---	---		Drai	---
Spin (Sec.)	---	0	0	---	---	---		0	---
<b>Fill 3</b>									
Time (Min.)	3	3	3	4	4	0		2	5
Water	Hot	Hot	Both	Cold	Cold	---		Cold	Cold
Level	Low	Low	Low	Low	Low	---		Low	Low
Supply	S1	S1	S1	S1	S1	---		S1	S1
Temp (C)	60	60	60	40	0	---		40	40
Drain	Drai	Drai	Drai	Drai	Drai	---		Drai	Drai
Spin (Sec.)	0	0	0	0	0	---		0	30
<b>Fill 4</b>									
Time (Min.)	4	4	4	4	5	0		3	0
Water	Hot	Hot	Hot	Both	Cold	---		Both	---
Level	Low	Low	Low	Low	Low	---	Low	---	
Supply	S2	S2	S2	S2	S2	---	S2	---	
Temp (C)	90	85	71	60	40	---	60	---	
Drain	No Dr	No Dr	No Dr	Drai	Drai	---	Drai	---	
Spin (Sec.)	0	0	0	30	30	---	30	---	
<b>Fill 5</b>									
Fill/over	Fill	Fill	Fill	Fill	Fill	Fill	Fill	Fill	
Time (Min.)	2	2	2	0	0	0	0	0	
Water	Cold	Cold	Cold	---	---	---	---	---	
Level	High	High	High	---	---	---	---	---	
Supply	S0	S0	S0	---	---	---	---	---	
Temp (C)	0	0	0	---	---	---	---	---	
Drain	Drai	Drai	Drai	---	---	---	---	---	
Spin (Sec.)	30	30	30	---	---	---	---	---	

Armstrong S-Series Microcomputers Cycles (Continued)									
Cycle Program	1 Very Hot 90°C	2 Hot Medical 85°C Sluice	3 Medical 71°C Sluice	4 Warm 60°C	5 Cool 40°C	6 Rinse and Spin	7-10	11 Warm Gentle 60°C Sluice	12 Cool Gentle 40°C
<b>Fill 6</b>							C U S T O M E R  R E Q U E S T E D  P R O G R A M S		
Time (Min.)	2	2	2	2	2	0		2	0
Water	Both	Both	Both	Both	Cold	---		Both	---
Level	High	High	High	High	High	---		High	---
Supply	S0	S0	S0	S0	S0	---		S0	---
Temp (C)	0	0	0	0	0	---		0	---
Drain	Drai	Drai	Drai	Drai	Drai	---		Drai	---
Spin (Sec.)	0	0	0	0	0	---		0	---
<b>Fill 7</b>									
Time (Min.)	2	2	2	2	2	2		2	2
Water	Cold	Cold	Cold	Cold	Cold	Both		Cold	Cold
Level	High	High	High	High	High	High		High	High
Supply	S0	S0	S0	S0	S0	S0		S0	S0
Temp (C)	0	0	0	0	0	0	0	0	
Drain	Drai	Drai	Drai	Drai	Drai	Drai	Drai	Drai	
Spin (Sec.)	30	30	30	30	30	30	30	30	
<b>Fill 8</b>									
Time (Min.)	3	3	3	3	3	3	3	3	
Water	Cold	Cold	Cold	Cold	Cold	Cold	Cold	Cold	
Level	High	High	High	High	High	High	High	High	
Supply	S3	S3	S3	S3	S3	S3	S3	S3	
Temp (C)	0	0	0	0	0	0	0	0	
Drain	Drai	Drai	Drai	Drai	Drai	Drai	Drai	Drai	
Spin (Sec.)	6	6	6	6	6	6	6	2	