

Washer-Extractor

Pocket Hardmount
UniLine Control

Refer to Page 9 for Model Identification

Programming

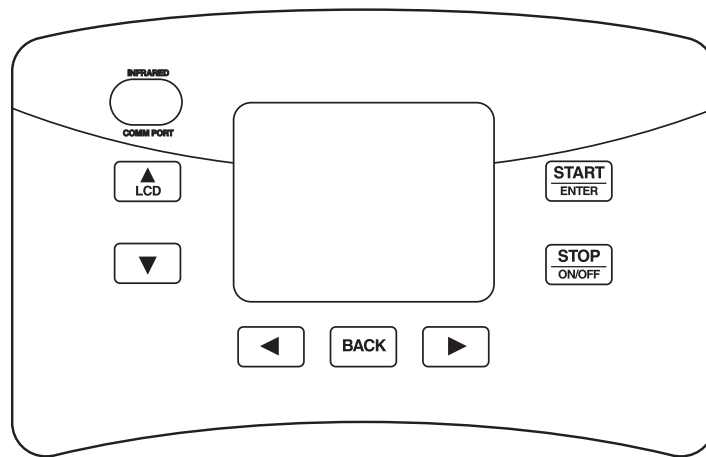

PHM1423C

Keep These Instructions for Future Reference.

(If this machine changes ownership, this manual must accompany machine.)



www.comlaundry.com

Part No. F8434101R1
April 2012

Table of Contents

Safety Information	5
Explanation of Safety Messages.....	5
Important Safety Instructions	5
Safety Decals	7
Operator Safety.....	8
Introduction	9
Model Identification	9
Nameplate Location.....	10
Replacement Parts	10
Customer Service.....	10
Preliminary Information	11
About the Control	11
Power Failure Recovery.....	11
IR Communications	11
Network Communications	11
Audit Information	11
IR Communications Menu.....	12
IR Communications Error Menu	12
Restore to Factory Defaults	12
Entering Program Mode.....	13
UniLinc Identification	14
Operational Keypad.....	14
Operation Modes	15
General Modes of Operation.....	15
Power-up Mode.....	15
Idle Mode	15
Door Locking Mode.....	15
Run Mode.....	15
Stop Mode.....	15
Door Unlocking Mode	15
Error Mode.....	15
Delayed Start Countdown Mode.....	15
Communication Mode	15
Entering Diagnostic Mode From Idle Mode.....	15
Machine Cycle Definition and Operation	16
Machine Cycle Operation.....	16
Delayed Start Feature	16
Cycle Menu.....	16
To Start a Cycle	17
Run Menu	18
Contrast/Backlight Menu.....	20
Close Door Menu.....	20
Lubricate Bearings Menu	21
Run Diagnostic Menu	21
Speed, Temp and Water Level Menu	22
Cycle Aborted Retry Menu.....	22
Cycle Aborted Fatal Menu.....	23

© Copyright 2012, Alliance Laundry Systems LLC

All rights reserved. No part of the contents of this book may be reproduced or transmitted in any form or by any means without the expressed written consent of the publisher.

Error Menu.....	23
Cycle Stopped Menu.....	23
Delayed Start Menu	23
Delayed Start Countdown Menu	24
Delayed Start Final Countdown Menu	24
Menu Navigation.....	25
The UniLinc.....	25
Menu Navigation on a Single Screen	25
Menu Navigation with Parameters	25
Screen to Screen Navigation using the Arrow Keypads.....	25
Navigation in String Edit Mode.....	25
Display Screen Maps	26
System Menu Map Tree.....	26
Run Menu Map Tree.....	27
Service Menu Map Tree.....	27
Programming UniLinc	28
System Menu	28
Save Changes Menu	28
Program Menu	29
Program Menu	29
Modify Cycle.....	29
Available Characters	30
Cycle, Segment and Step Programming Flow Diagram.....	31
Step Menu Navigation	31
Reuse Fill Step Menu.....	32
Fill Step Menu.....	33
Heater Option.....	34
Supply A and B Step Menu	34
Agitate Step Menu	35
Cool Down Step Menu.....	35
Drain Step Menu	36
Spray Rinse Extract Step Menu	36
Extract Step Menu.....	37
General Purpose Signals Menu.....	37
End of Segment Audio Signal Step Menu	38
Global Setup	39
Global Setup Menu	39
Language Menu	39
Date/Time Menu.....	39
Water Level Menu	40
Temperature Menu.....	40
Audio Menu	41
Balance Retry Menu	41
Water Management Menu	42
Alarms Program Menu	44
Rapid Advance Menu	44
Shakeout Menu	45

Banners Menu	45
Factory Defaults Menu	45
Water Level Confirmation Menu.....	46
Water Temperature Confirmation Menu	46
Alarms Confirmation Menu.....	46
Audio Confirmation Menu	47
Reset All Factory Defaults Confirmation Menu.....	47
Factory Defaults Second Confirmation Menu.....	47
Diagnostic	48
Diagnostic Menu.....	48
Drive ID Menu.....	48
Drive Alarms Menu	48
Test Menu	48
Test Cycle	49
Factory Valve Purge Menu.....	51
Inputs Outputs Menu	51
Water Leak Detection Diagnostic.....	53
Drive Test	53
Alarms.....	54
Machine Identification.....	55
Machine Errors	55
Door Lock Error	55
Door Open Error	55
Drain Alarm Error	55
Fill Alarm Error	55
Frame Balance Switch Error.....	56
Open Temperature Sensor Error	56
Shorted Temperature Sensor Error	56
SPI Error	56
Unbalance Error	56
Heat Alarm Error	56
Water Level Sensor Error	57
IR Communications Error.....	57
Network Communications Error.....	57
Water Leak Detection Error.....	57
Slow Drain Detected During A Machine Cycle Error.....	58
Drive SPI Error	58
DC Bus Error	58
No Tachometer Error	58
Locked Rotor Error	58
Shorted IGBT Error	58
IPM Overtemperature Error.....	59
Invalid Parameter Set Error	59
Maximum Current Exceeded Error.....	59
Current Sensor Error	59
Low DC Bus Error	59
Invalid Command Error	59
Last Drive Error	59

Laundry Management	60
Total Number of Machine Cycle Counters.....	61
Total Number of Operating Minutes Counters.....	61
Last 10 Machine Cycles Rapid Advanced or Stopped	61
Maintenance	62
Service Schedule Menu	62
Daily Menu (Service).....	62
Weekly Menu (Service)	62
Monthly Menu (Service).....	63
Quarterly Menu (Service)	63
Cycle Charts	64

Safety Information

Explanation of Safety Messages

Precautionary statements (“DANGER,” “WARNING,” and “CAUTION”), followed by specific instructions, are found in this manual and on machine decals. These precautions are intended for the personal safety of the operator, user, servicer, and those maintaining the machine.

	DANGER
DANGER indicates the presence of a hazard that will cause severe personal injury, death, or substantial property damage if the danger is ignored.	

	WARNING
WARNING indicates the presence of a hazard that can cause severe personal injury, death, or substantial property damage if the warning is ignored.	

	CAUTION
CAUTION indicates the presence of a hazard that will or can cause minor personal injury or property damage if the caution is ignored.	

Additional precautionary statements (“IMPORTANT” and “NOTE”) are followed by specific instructions.

IMPORTANT: The word “IMPORTANT” is used to inform the reader of specific procedures where minor machine damage will occur if the procedure is not followed.

NOTE: The word “NOTE” is used to communicate installation, operation, maintenance or servicing information that is important but not hazard related.

Important Safety Instructions

	WARNING
To reduce the risk of fire, electric shock, serious injury or death to persons when using your washer, follow these basic precautions:	
W023	

1. Read all instructions before using the washer.
2. GInstall the washer according the INSTALLATION instructions. Refer to the GROUNDING instructions in the INSTALLATION manual for the proper grounding of the washer. All connections for water, drain, electrical power and grounding must comply with local codes and be made by licensed personnel when required. It is recommended that the machine be installed by qualified technicians.
3. Do not install or store the washer where it will be exposed to water and/or weather.
4. To prevent fire and explosion, keep the area around machine free from flammable and combustible products. Do not add the following substances or textiles containing traces of the following substances to the wash water: gasoline, kerosene, waxes, cooking oils, vegetable oils, machine oils, dry-cleaning solvents, flammable chemicals, thinners, or other flammable or explosive substances. These substances give off vapors that could ignite, explode or cause the fabric to catch fire by itself.
5. Under certain conditions, hydrogen gas may be produced in a hot water system that has not been used for two weeks or more. HYDROGEN GAS IS EXPLOSIVE. If the hot water system has not been used for such a period, before using a washing machine or combination washer-dryer, turn on all hot water faucets and let the water flow from each for several minutes. This will release any accumulated hydrogen gas. The gas is flammable, do not smoke or use an open flame during this time.
6. To reduce the risk of an electric shock or fire, DO NOT use an extension cord or an adapter to connect the washer to the electrical power source.

Safety Information

7. Do not allow children to play on or in the washer. Close supervision of children is necessary when the washer is used near children. This appliance is not intended for use by young children or infirm persons without supervision. Young children should be supervised to ensure that they do not play with the appliance. This is a safety rule for all appliances.
8. DO NOT reach and/or climb into the tub or onto the washer, ESPECIALLY if the wash drum is moving. This is an imminently hazardous situation that, if not avoided, will cause severe personal injury or death.
9. Never operate the washer with any guards, panels and/or parts removed or broken. DO NOT bypass any safety devices or tamper with the controls.
10. Use washer only for its intended purpose, washing textiles. Never wash machine parts or automotive parts in the machine. This could result in serious damage to the basket or tub.
11. Use only low-sudsing, no-foaming types of commercial detergent. Be aware that hazardous chemicals may be present. Wear hand and eye protection when adding detergents and chemicals. Always read and follow manufacturer's instructions on packages of laundry and cleaning aids. Heed all warnings or precautions. To reduce the risk of poisoning or chemical burns, keep them out of the reach of children at all times (preferably in a locked cabinet).
12. Do not use fabric softeners or products to eliminate static unless recommended by the manufacturer of the fabric softener or product.
13. Always follow the fabric care instructions supplied by the textile manufacturer.
14. Loading door MUST BE CLOSED any time the washer is to fill, tumble or spin. DO NOT bypass the loading door switch by permitting the washer to operate with the loading door open. Do not attempt to open the door until the washer has drained and all moving parts have stopped.
15. Be aware that hot water is used to flush the supply dispenser. Avoid opening the dispenser lid while the machine is running.
16. Do not attach anything to the supply dispenser's nozzles, if applicable. The air gap must be maintained.
17. Do not operate the machine without the water reuse plug or water reuse system in place, if applicable.
18. Be sure water connections have a shut-off valve and that fill hose connections are tight. CLOSE the shut-off valves at the end of each wash day.
19. Keep washer in good condition. Bumping or dropping the washer can damage safety features. If this occurs, have washer checked by a qualified service person.
20. DANGER: Before inspecting or servicing machine, power supply must be turned OFF. The servicer needs to wait for at least 3 minutes after turning the power OFF and needs to check for residual voltage with a voltage meter. The inverter capacitor or EMC filter remains charged with high voltage for some time after powering OFF. This is an imminently hazardous situation that, if not avoided, will cause severe personal injury or death.
21. Do not repair or replace any part of the washer, or attempt any servicing unless specifically recommended in the user-maintenance instructions or in published user-repair instructions that the user understands and has the skills to carry out. ALWAYS disconnect the washer from electrical, power and water supplies before attempting any service.
22. Disconnect the power cord by grasping the plug, not the cord. Replace worn power cords and/or loose plugs. If the supply cord is damaged, it must be replaced by a special cord or assembly available from the service agent.
23. Before the washer is removed from service or discarded, remove the door to the washing compartment.
24. Failure to install, maintain, and/or operate this washer according to the manufacturer's instructions may result in conditions which can produce bodily injury and/or property damage.

NOTE: The WARNINGS and IMPORTANT SAFETY INSTRUCTIONS appearing in this manual are not meant to cover all possible conditions and situations that may occur. Common sense, caution and care must be exercised when installing, maintaining, or operating the washer.

Any problems or conditions not understood should be reported to the dealer, distributor, service agent or the manufacturer.

	WARNING
<p>This machine must be installed, adjusted, and serviced by qualified electrical maintenance personnel familiar with the construction and operation of this type of machinery. They must also be familiar with the potential hazards involved. Failure to observe this warning may result in personal injury and/or equipment damage, and may void the warranty.</p>	
SW004	

	CAUTION
<p>Ensure that the machine is installed on a level floor of sufficient strength and that the recommended clearances for inspection and maintenance are provided. Never allow the inspection and maintenance space to be blocked.</p>	
SW020	

	CAUTION
<p>Be careful around the open door, particularly when loading from a level below the door. Impact with door edges can cause personal injury.</p>	
SW025	

	WARNING
<p>Never touch internal or external steam pipes, connections, or components. These surfaces can be extremely hot and will cause severe burns. The steam must be turned off and the pipe, connections, and components allowed to cool before the pipe can be touched.</p>	
SW014	

Safety Decals

Safety decals appear at crucial locations on the machine. Failure to maintain legible safety decals could result in injury to the operator or service technician.

Use manufacturer-authorized spare parts to avoid safety hazards.

Operator Safety

	WARNING
NEVER insert hands or objects into basket until it has completely stopped. Doing so could result in serious injury.	
<small>SW012</small>	

The following maintenance checks must be performed daily:

1. Verify that all warning signs are present and legible, replace as necessary.
2. Check door interlock before starting operation of the machine:
 - a. Attempt to start the machine with the door open. The machine should not start.
 - b. Close the door without locking it and start the machine. The machine should not start.
 - c. Attempt to open the door while a cycle is in progress. The door should not open.

If the door lock and interlock are not functioning properly, disconnect power and call a service technician.

3. Do not attempt to operate the machine if any of the following conditions are present:
 - a. The door does not remain securely locked during the entire cycle.
 - b. Excessively high water level is evident.
 - c. Machine is not connected to a properly grounded circuit.

Do not bypass any safety devices in the machine.

	WARNING
Operating the machine with severe out-of-balance loads could result in personal injury and serious equipment damage.	
<small>W728</small>	

NOTE: All information, illustrations, and specifications contained in this manual are based on the latest product information available at the time of printing. We reserve the right to make changes at any time without notice.

Introduction

Model Identification

Information in this manual is applicable to these models:

UWL045T3V	UWN065T4L
UWL045T4V	UWN065T4M
UWL065T3V	UWU045T3V
UWL065T4V	UWU045T4V
UWN045T3V	UWU065T3L
UWN045T4V	UWU065T3M
UWN065T4V	UWU065T3V
UWN065T3L	UWU065T4L
UWN065T3M	UWU065T4M
UWN065T3V	UWU065T4V

Introduction

Nameplate Location

The nameplate is located on the back of the machine and is programmed in the UniLinc Control. To access Machine ID through the control:

1. Press and hold **STOP ON/OFF**, then **BACK**, then **▲ LCD** keypads at the same time.
2. Press the **▶** keypad until Diagnostic is highlighted.
3. Press the **START ENTER** keypad.
4. Press the **▶** keypad until Machine ID is highlighted.
5. Press the **START ENTER** keypad.

Always provide the machine's serial number and model number when ordering parts or when seeking technical assistance. Refer to *Figure 1*.

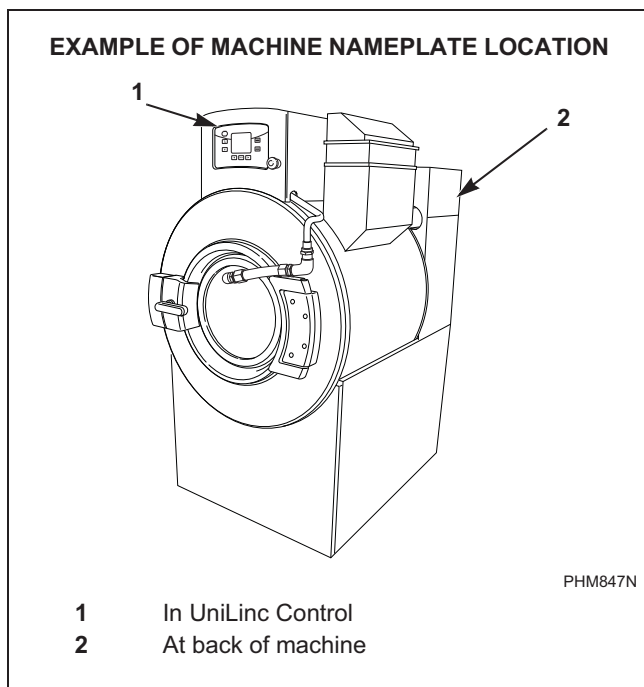

Figure 1

Replacement Parts

If literature or replacement parts are required, contact the source from which the machine was purchased or contact Alliance Laundry Systems LLC at +1 (920) 748-3950 for the name of the nearest authorized parts distributor. A parts manual may be ordered by returning the reply card provided with each machine.

Customer Service

For technical assistance, contact your local distributor or call:

Alliance Laundry Systems

Shepard Street

P.O. Box 990

Ripon, WI 54971-0990

U.S.A.

www.comlaundry.com

Phone: +1 (920) 748-3121

Ripon, Wisconsin

Alliance International

+32 56 41 20 54

Wevelgem, Belgium

Preliminary Information

About the Control

The UniLinc control on the machine is an advanced, graphical, programmable computer that lets the owner control most machine features by interacting with the control.

UniLinc allows the owner to program custom cycles, run diagnostic cycles and retrieve audit, error and bearing information.

Machines shipped from the factory have default cycles and wash temperature settings built in. The owner can change the default cycles or any cycle.

IMPORTANT: It is extremely important that the machine has a positive ground and that all mechanical and electrical connections are made before applying power to or operating the machine.

Power Failure Recovery

If a cycle is in progress when the power fails, and if the power outage lasts three or more seconds, the cycle is lost and cannot be resumed when power recovers. If the power outage lasts less than three seconds, the control will resume the cycle when the power recovers.

IR Communications

The control has the ability to communicate with a PDA or PC with an IrDA device running the UniLinc software. Devices such as PDAs and PCs that are IrDA capable (able to transmit information to machine) that have been tested and approved for use with the UniLinc software can be used as a tool for managing the machine.

Network Communications

The control has the ability to communicate through a network. The network link allows the user to program, collect data, and run diagnostics on any machine in the network from a central location.

Audit Information

The control collects and stores audit information, which can be accessed with a PC/PDA or through the network. Refer to the following list for available audit information.

- Total Number of Individual Cycle Counters
- Last 25 Machine Cycles
- Service History
- Machine Errors Audit Data
- Communication Audit Data
- Re-Programming Audit Data
- Power Failures Audit Data
- Average Fill Time Audit Data
- Average Drain Time Audit Data
- Power Failure Audit Data

The PC/PDA or the network can receive audit and program data from the control, and send programming data and diagnostic commands to the control.

Refer to *UniLinc PC and PDA Application User Instructions* for additional information on using a PC/PDA.

Preliminary Information

IR Communications Menu

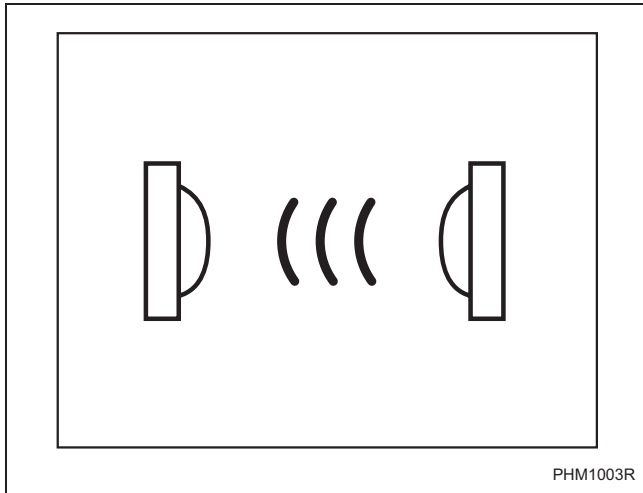

Figure 2

The IR Communications Menu displays while the control is communicating with a PC/PDA. The control will jump back to the previous page when the communication is complete.

IR Communications Error Menu

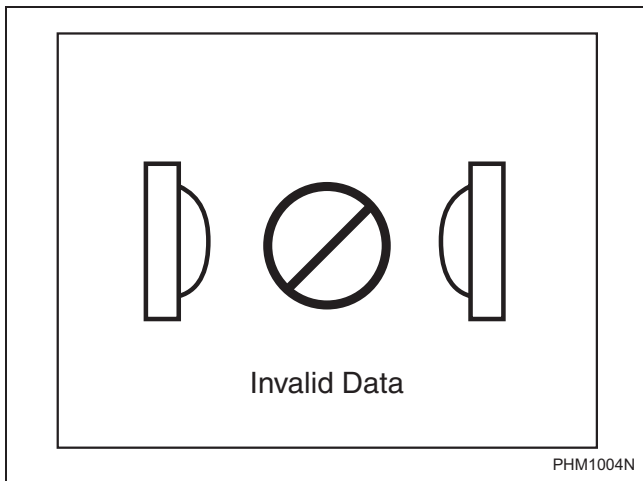

Figure 3

The IR Communications Error Menu displays after the control had an error communicating with a PC/PDA. The control will return to previous page after 3 seconds.

Restore to Factory Defaults

When the user selects Restore All Cycles And Global Settings To Factory-Defaults, the control resets all of the default values. The control also resets Machine Cycles #1 through #41. The control will also reset the following to factory defaults:

Default Machine Settings

Language = English

Maximum Balance Retries = 3

Water Reuse = Disabled

Rapid Advance = Enabled

Water Recirculation = Disabled

External Dispenser Pause = Disabled

Shakeout = 40 seconds

Banner # 1 = Blank

Banner # 2 = Blank

Daylight Saving = Enabled

Water Levels

High = 27

Medium = 15

Low = 3

Water Temperature

Hot = 140 F

Warm = 100 F

Cold = 35 F

Cooldown = 110 F

Temperature Controlled Fill = Disabled

Audio Signal External Signal = Disabled

Keypad Signal (beep) = Enabled

Alarms

Fill = 5 minutes

Drain = 2 minutes

Heat = 1 hour 30 minutes

End of Segment / Cycle Sound = Enabled Low, 5 second duration

Advanced Options for Water Management = Disabled

Water Leak Detection During Machine Cycle = Disabled

Number of Cycles Between = 0

Day(s) Occuring = none

Slow Drain Detection During Machine Cycle = Disabled

Slow Drain Adjustment = 0 seconds

Auto-Water Leak Detection = Disabled

Number of Cycles Between = 0

Hours Occuring = 0 (12:00 AM)

Days(s) Occuring = none



Manual Programming = Enabled*

Manual Diagnostics = Enabled*

*If manual programming is disabled, programming changes to UniLinc can only be made with an external communication device. Refer to ***UniLinc PC and PDA Applications User Instructions***.

Refer to Factory Defaults, Menu section for information on Restoring Factory Defaults.

Entering Program Mode

1. Press and hold , then , then  to enter the System Menu. Select Program to enter programming options.

UniLinc Identification

Operational Keypad

The control includes seven keypads. These functions are available to the operator and are intended to control and manage operation of the machine. Refer to *Figure 4* and *Table 1*.

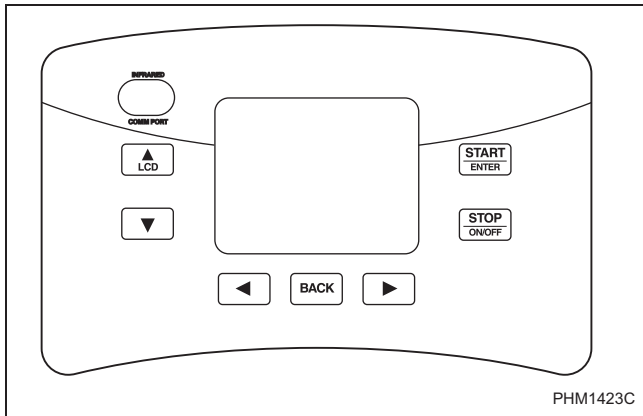

Figure 4















Keypad	Description
LCD/UP ARROW 	Press to move the cursor on display to edit programming values. Also, press while in Cycle Menu or Run Menu to change to the Contrast Adjust/Backlight Menu. Also, press with  and  to enter System Menu.
DOWN ARROW 	Press to move the cursor on display or edit programming values.
LEFT ARROW 	Press to move cursor on display.
BACK 	Press to move back to the previous display menu. Also, press with  and  to enter System Menu. Also, back from the Cycle Menu to enter the Service Schedule Menu.
RIGHT ARROW 	Press to move cursor on display. Press while running a cycle to get to Run Diagnostic Menu. Press and hold with  to enter Delayed Start Menu.
STOP/ON/OFF 	Press to stop and abort a machine cycle during Run Mode. Also press with  and  to enter System Menu. Press with  to enter Delayed Start Menu.
START/ENTER 	Press to start or rapid advance a machine cycle during Run Mode. Also, press to save edited programming values when used in programming menus.

Table 1

Operation Modes

General Modes of Operation

In each mode of operation, the user may press keypads or communicate with the control to change the displayed menu.

Power-up Mode

The control enters this mode at power-up. After the control completes operation in the Power-up Mode it will enter Idle Mode. The display is blank during Power-up Mode.

Idle Mode



Control is ready for operation in Idle Mode. Control can display different menus depending on user input (keypad press, opening or closing the loading door, or PC/PDA or network communication). If there is no user input for one minute, control will turn off the LCD backlight. Control will light when there is user input. If there is no user input for 10 minutes, display will go blank.

If control is in Idle Mode, Cycle Menu is displayed, loading door closed, and the  keypad is pressed, control will enter Door Locking Mode.

Door Locking Mode

The control enters this mode after the  keypad is pressed in Idle Mode. The control will stay in the Door Locking Mode until it confirms the loading door is closed and locked. The control will enter Run Mode.

Run Mode

Control enters Run Mode during a cycle. Display shows machine cycle time remaining, the colon flashing one second on/one second off indicating that the cycle time is counting down, and the display will indicate the current cycle step. Loading door is closed and locked during Run Mode. Press  keypad to end cycle and enter Stop Mode. Press  keypad to Rapid Advance to the next cycle step (if the Rapid Advance feature is enabled. The Rapid Advance feature is enabled by default.) Control enters Error Mode if loading door unlocks or opens.

Stop Mode

If  keypad is pressed before cycle ends, control enters Stop Mode and performs the following steps:

- Displays a hourglass.
- Turns off all outputs.
- Verifies water is drained.
- Verifies motor is stopped by either rotation sensor or time.
- Enters Door Unlocking Mode.

Door Unlocking Mode



The control enters this mode after cycle has ended. The control waits for confirmation that door is unlocked. Once confirmation is received that door is unlocked, control will enter Idle Mode.

Error Mode

This mode will be entered to display all alarms and machine errors.

Delayed Start Countdown Mode

Delayed Start Countdown Menu is entered after delayed start is activated. The display will show the hours and minutes remaining until the machine will automatically start.

The Delayed Start Final Countdown Menu is entered during the last sixty seconds before the control is automatically started. The  keypad will start the selected cycle immediately. Press  to return to the Cycle Menu.

Communication Mode

This mode is entered whenever the control is communicating with a PC/PDA or through the network.

Refer to *UniLinc PC and PDA Applications User Instructions*.

Entering Diagnostic Mode From Idle Mode

When entered from the Idle Mode, the control will be running a test selected by the user via keypad presses or communication with a device. The diagnostic tests available from the Idle Mode are the Test Cycle, Test Balance Weight, and Inputs Outputs Menus.

Machine Cycle Definition and Operation

There are 41 machine cycles which can be selected and run. Machine cycles can be modified or made “unavailable” by manually editing them in Modify Cycle Menu or by using the PC/PDA or the network to download a modified machine cycle into the control. Machine cycles cannot be deleted, but can be made “unavailable” so that they are not visible from the Cycle Menu. New machine cycles cannot be created, but existing machine cycles that have been edited to be “unavailable” may be re-edited to be available again.

Machine Cycle Operation

When a cycle is run, the control runs the cycle segment by segment and step by step in a sequence. The first segment can be programmed to “Off”, “Prewash”, “Wash” or “Rinse”. If the segment is programmed to “Off”, control skips to the next segment. If the segment is not programmed to “Off”, the first segment step (Reuse Fill step) is examined to see if it is programmed on. If the segment step is programmed on, it is executed and the next step follows until the segment is complete. Any segment steps programmed to “Off” are skipped.

At the start of a machine cycle, the control displays a Total Remaining Cycle time. This time is taken from the audit data for this cycle where there is stored an average time elapsed for the last three of these cycles that had been completed. The Total Remaining Cycle Time begins to count down as soon as the cycle is started. Since there will be differences between the average elapsed cycle time and the actual elapsed cycle time, the Total Remaining Cycle Time displayed is corrected at the start of the cycle’s final enabled step that has programmed time duration.

Delayed Start Feature

The user can select a machine cycle to run at a later time. Refer to *Delayed Start Menu Section*.

Cycle Menu

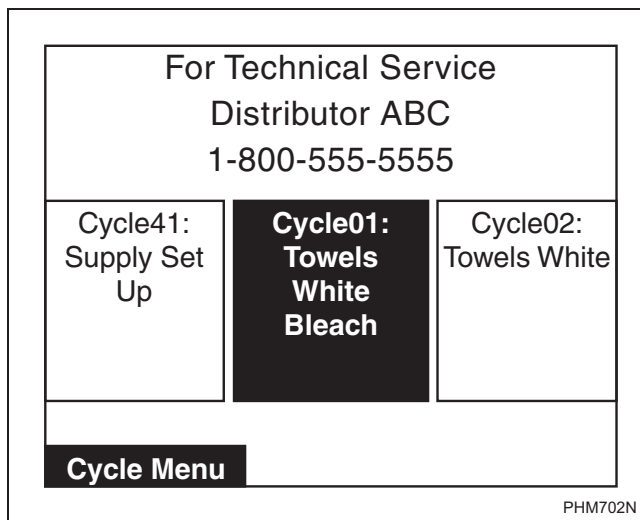



Figure 5

The Cycle Menu is the first menu displayed by the control at power-up. The Cycle Menu allows the user to select one of the 41 machine cycles. Machine cycles that are turned off will not be displayed in the Cycle Menu. As a default, the last run cycle will be displayed in the center, highlighted position. The factory default cycle will be Cycle01.

To Start a Cycle

1. Press the ◀ or ▶ keypad to change cycles.
2. Press the ▶ keypad to move the cycle in the rightmost menu box to the center, highlighted position.
3. Press the ◀ keypad to move the cycle in the leftmost menu box to the center, highlighted position.
4. Moving the ◀ and ▶ keypads allows the Cycle Menu to scroll through the center, highlighted position.
5. Press  to start selected cycle.

NOTE: Press and hold ◀ or ▶ keypad to make highlighted area move rapidly.

NOTE: If door is not closed when the  keypad is pressed, display will jump to the Close Door Menu.

NOTE: If the machine has operated over 200 hours and the Lubricate Bearings has not been reset from the System Menu the Global Settings, a reminder screen will pop up. The Lubricate Bearings Menu will be display for five seconds and the Cycle Menu will display for five seconds. This will occur until the Bearing Timer is reset in the System Menu. The Lubricate Bearings Menu will only be shown during the Cycle Menu.

Every night at midnight the control will enter Service Schedule Menu if the machine is in idle mode on the Cycle Menu.

When a keypad is pressed or the door is opened or an IR communication takes place the control will turn the LCD contrast on and the backlight back on (if programmed).

Control will also enter specific service sub-menu for that day.







Quarterly Menu displays on the first day of the month for January, April, July and October.

Monthly Menu displays on all other first days of the month.

Weekly Menu displays on a Monday not on the first day of the month. All other days the control will display the Daily Menu.

Press any keypad to clear the menu and enter Cycle Menu.

Optional settings are performed by either pressing a keypad or by a combination of keypad presses:

- Press the  keypad to jump control to the Contrast Adjust/Backlight Menu.
- Press the  keypad to enter the Service Schedule Menu.
- Press and hold  then  to enter Delayed Start Menu.
- Press and hold  then  then  to enter the System Menu.

A Banner is displayed above the Cycle Selections in the Cycle Menu. If Banner 1 and Banner 2 are programmed, Banner 1 displays for ten (10) seconds and Banner 2 displays for ten (10) seconds. If only one Banner is programmed it will be the only one shown. Refer to Banner Menu Section.

During communication with the PC/PDA, all menus enter IR Communications Menu.

Run Menu

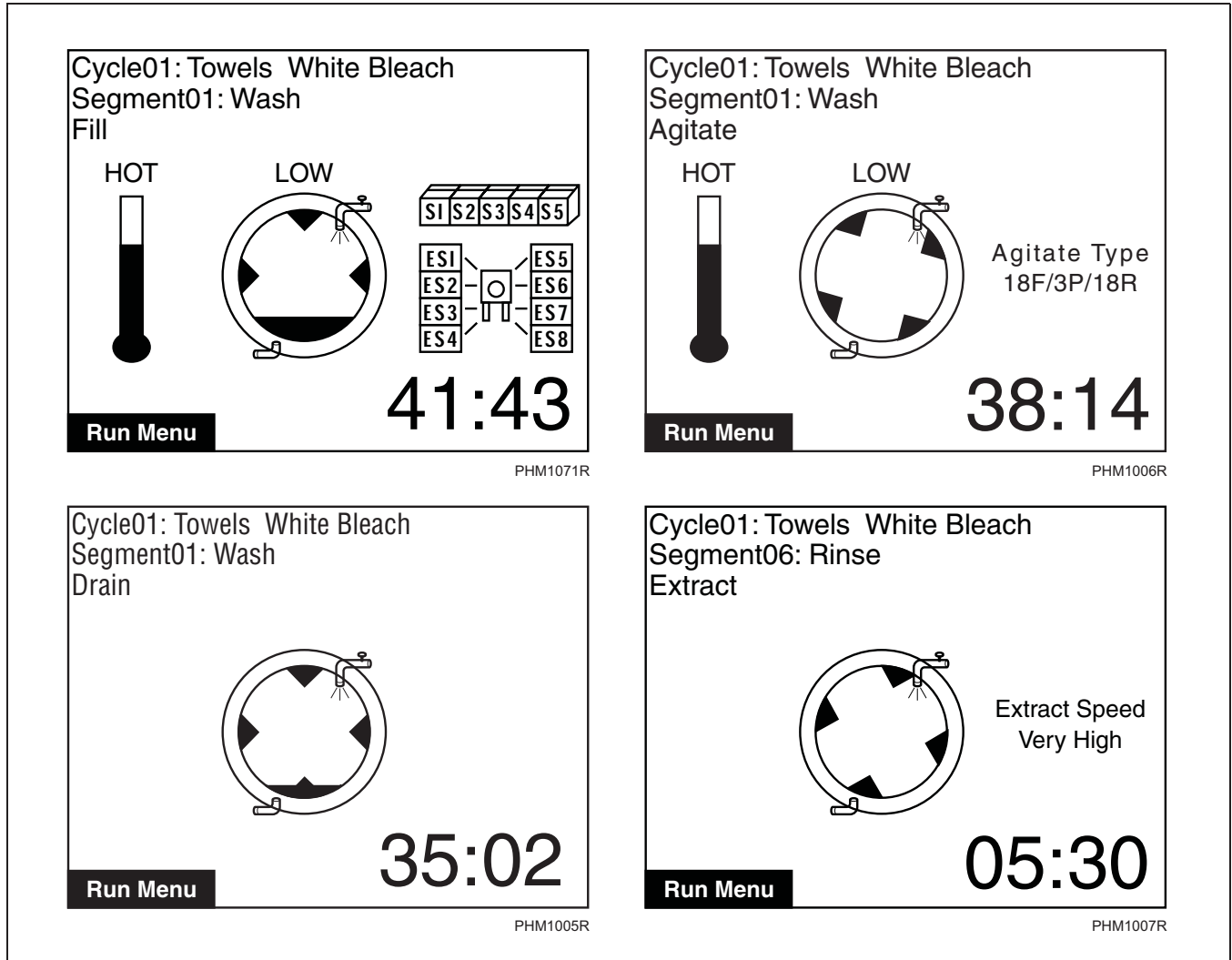

Figure 6

Run Menu provides cycle, segment, and step information while the machine is operating. Refer to *Figure 6*.

Supplies are only shown during the fill and supply steps.

During the agitate steps the type of agitation is shown. During the extract steps, the extraction speed displays.

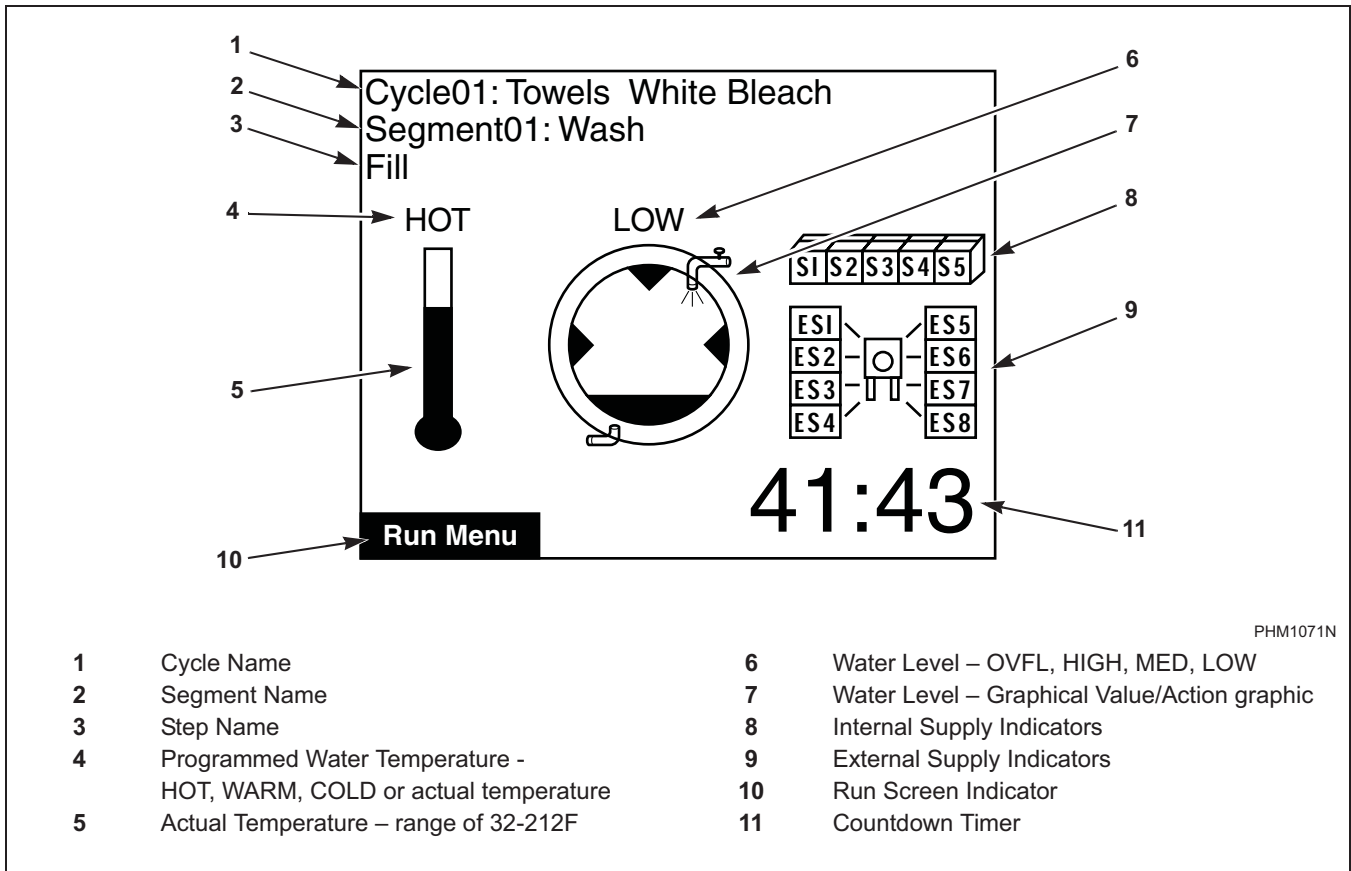





Figure 7

The Run Menu cannot be navigated by manipulating the arrow keypads. Press  keypad to advance the cycle one step. The Control cannot advance into a Spray Rinse Extract or an Extract Cycle Step. Advancing the steps within a cycle also depends on whether the option has been toggled on or off in the Rapid Advance Menu.

The Run menus include the Run Menu, the Run Diagnostic Menu, and the various sub-screens of the Run Diagnostic Menu. Press the  keypad to jump to the Run Diagnostic Menu.

Press the  keypad to stop the cycle in any of the Run menus.

When the  keypad is pressed, the display will jump to the Cycle Stopped Menu showing an hourglass.

Contrast/Backlight Menu

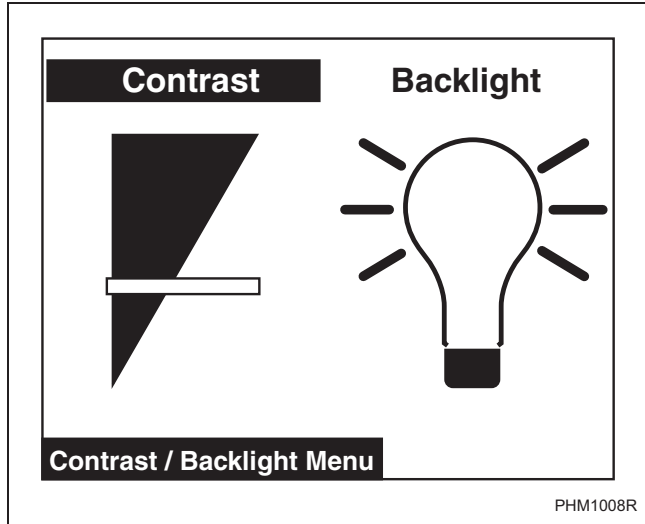







Figure 8

Press the  keypad from Cycle Menu or Run Menu to enter the Contrast Adjust/Backlight Menu. The Contrast Adjust/Backlight Menu allows the user to adjust contrast and turn the backlight on or off.

Press the  or  keypad to highlight “Contrast” or “Backlight” menu items.

Once the menu item has been selected, press the  or  keypad to change contrast. The backlight is either on or off and will have a factory default of on.

Press the  keypad to enter the previous page.

If the Contrast Adjust/Backlight Menu is selected from the Run Menu and the  keypad is pressed, the Cycle is aborted.

Close Door Menu

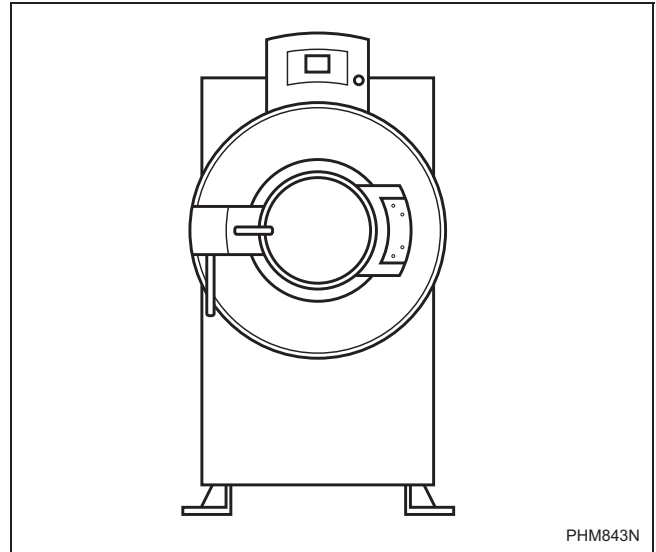



Figure 9

The Close Door Menu displays when loading door on the machine is open and needs to be closed.

Close door to start cycle or press the  keypad to return to Cycle Menu.

Lubricate Bearings Menu

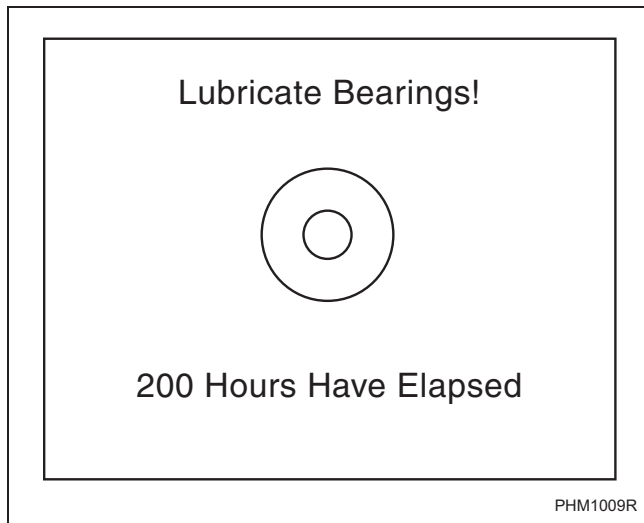

Figure 10

The Lubricate Bearings Menu displays when the machine has run for 200 hours and the bearing is the type that can be lubricated. The Lubricate Bearings Menu displays during Idle Mode when the Cycle Menu is displayed. The Lubricate Bearing Menu and Cycle Menu will alternate being displayed.

To remove the Lubricate Bearings Menu from being shown during Idle Mode, the user must reset the bearing timer by navigating to the System Menu and reset the bearing timer. Press any keypad to display Cycle Menu while viewing Lubricate Bearings Menu.

Run Diagnostic Menu

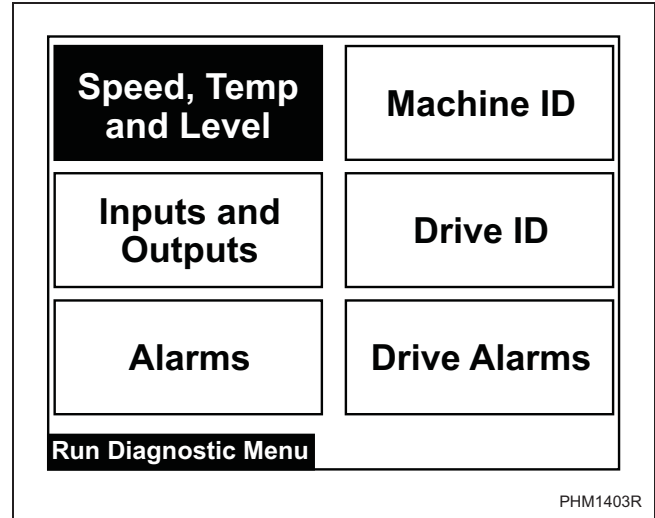



Figure 11

The Run Mode Diagnostic Menu allows user to access diagnostic information of the cycle currently running. The menu contains speed, temperature, water level, inputs and outputs, alarms, machine ID, Drive ID and Drive Alarms.

While machine is running, press the  keypad to enter Run Diagnostic Menu.

Press the , ,  LCD, or  keypad to navigate the menu.

Press the  keypad to choose selection.

If the  keypad is pressed, display enters Run Menu. If nothing is selected for 15 seconds, the display will return to Run Menu.

Speed, Temp and Water Level Menu

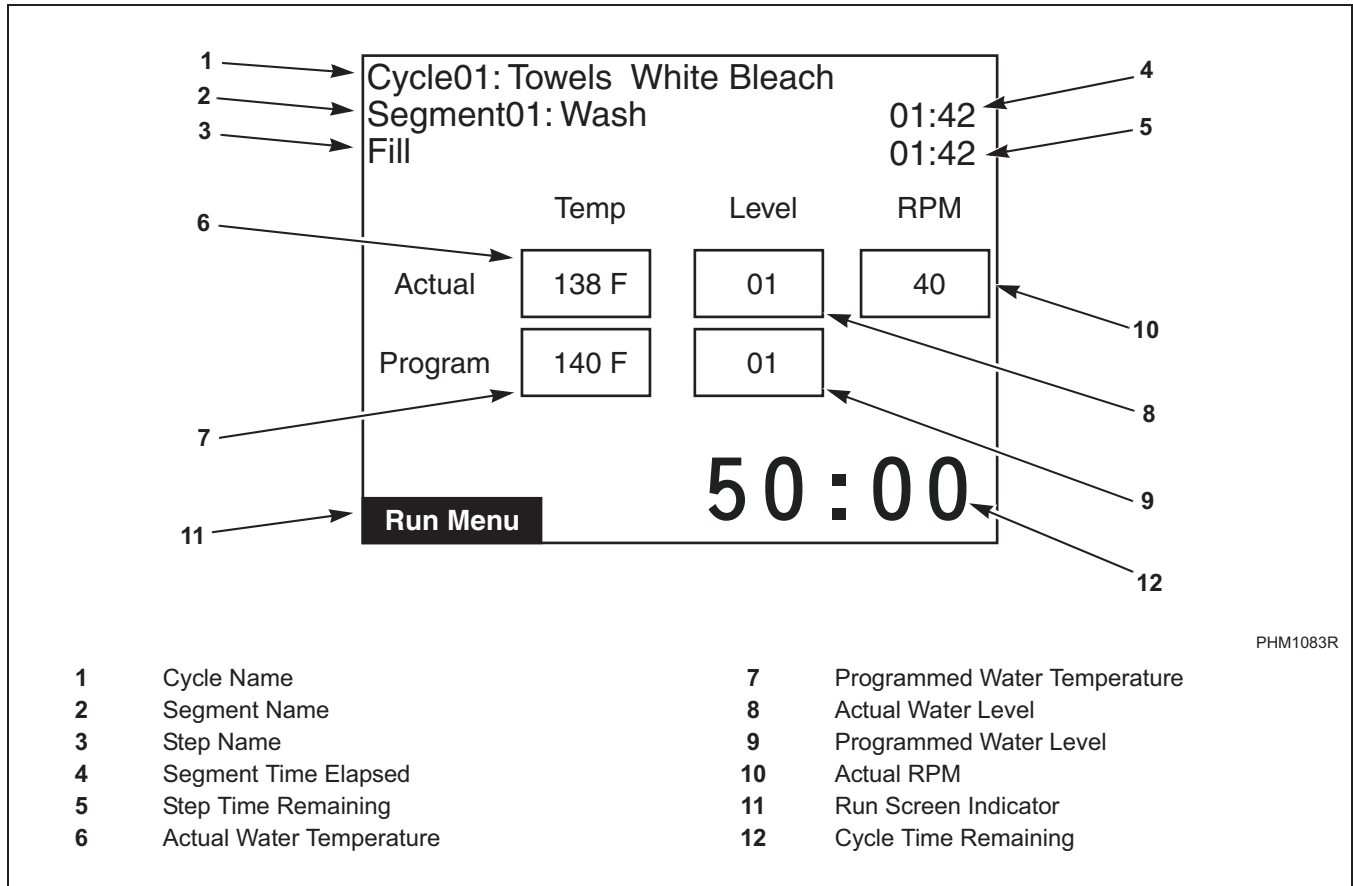

Figure 12

The Speed, Temp, and Level Menu will display the actual RPM, temperature and level, and program values of the temperature and level during run mode. The top portion of the display contains the same information listed in the Run Menu detailing Cycle, Segment, and Step operation.

Press **BACK** keypad to enter Run Mode Diagnostic Menu. Press **STOP ON/OFF** keypad to stop the cycle, the control will enter Cycle Stopped if there is rotation or the Unlock Door page if there is not rotation. Press the **START ENTER** keypad to advance the cycle one step. The Control cannot advance into a Spray Rinse Extract or an Extract Cycle Step. Advancing the steps within a cycle also depends on whether this option has been changed to on or off in the Rapid Advance Menu.

Cycle Aborted Retry Menu

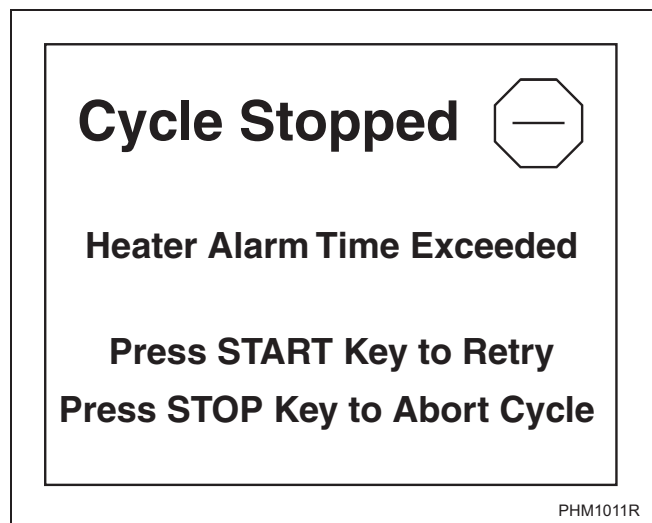

Figure 13

The Cycle Aborted Retry Menu will be displayed for a fill, drain or heater alarm time error. The display will toggle this page with the Run Menu every three seconds. Press **START ENTER** to resume the cycle.

Press **STOP ON/OFF** keypad to abort the cycle. After two minutes without a keypad press the control will abort the cycle and go to the Cycle Aborted Fatal Menu.

Cycle Aborted Fatal Menu

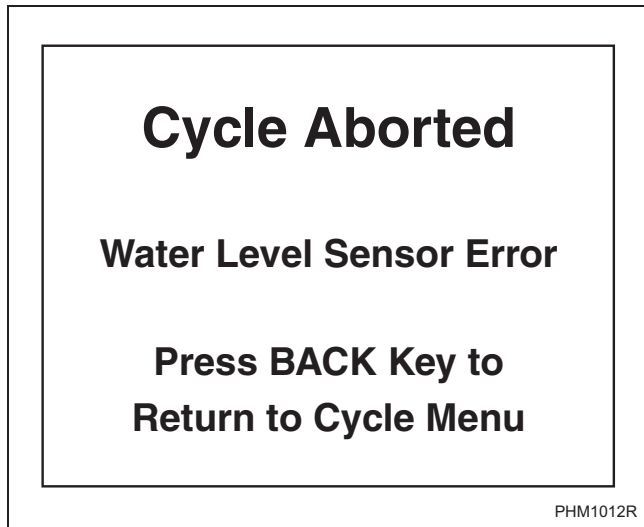

Figure 14

The Cycle Aborted Fatal Menu will be displayed during any fatal errors or if the cycle is aborted from the Cycle Aborted Retry Menu. Press the **BACK** keypad to exit the menu. Control will go to the Cycle Stopped Menu or the Unlock Door Menu (depending on if there is rotation or water present).

Error Menu

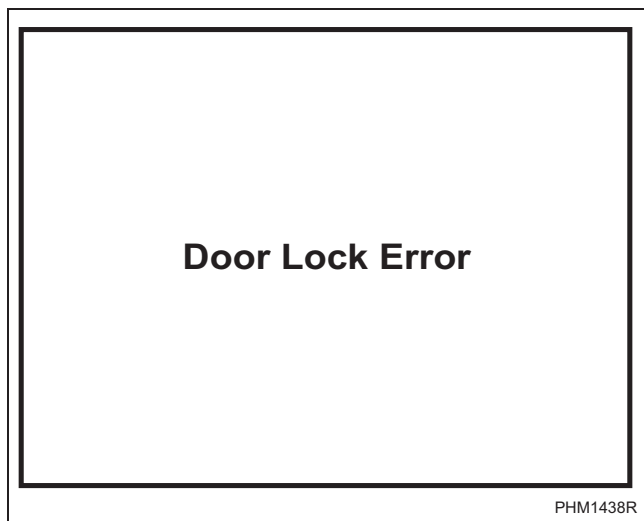

Figure 15

The Error Menu will be displayed if an error occurs in Idle Mode. The control will return to the previously displayed menu when the error clears.

Cycle Stopped Menu

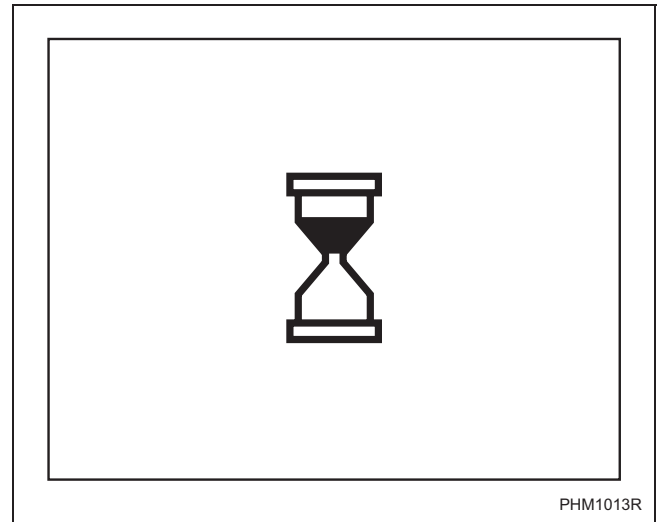

Figure 16

The Cycle Stopped Menu is displayed while the control is waiting for the basket to stop spinning. After rotation is complete and the water has drained from the machine the control will go to the Unlock Door Menu.

Delayed Start Menu

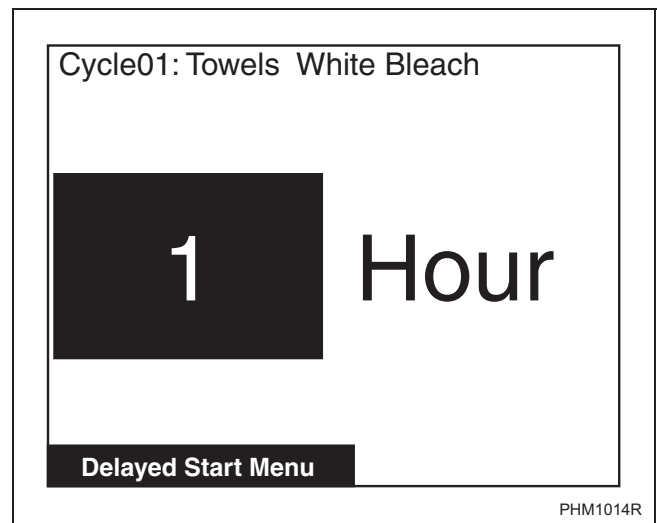

Figure 17

The Delayed Start Menu allows user to select in how many hours the cycle should start.

Delayed Start Menu is only available from the Cycle Menu.

If the loading door is opened, if the **STOP ON/OFF** keypad is pressed, or if there is a power failure during the delay, the Delayed Start is aborted and is recorded as an aborted cycle in the Last 10 Cycles Rapid Advance or Stopped Audit Queue.

Machine Cycle Definition and Operation

NOTE: 24 hours is the maximum delayed start time.

To activate a delayed start cycle:

1. Select the desired cycle for delayed start.
2. Press and hold **STOP ON/OFF** and **▶** keypads. The cycle that was selected will display with the Delayed Start Menu.
3. Press the **▲ LCD** or **▼** keypad to alter the number of hours.
4. Press the **BACK** keypad to go back to Cycle Menu.
5. Press the **START ENTER** keypad to enter Delayed Start Countdown Time Menu.

Delayed Start Countdown Menu

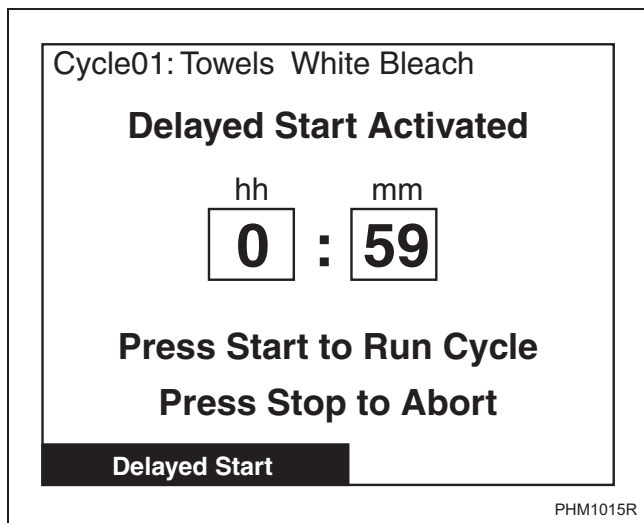

Figure 18

The Delayed Start Countdown Menu will be shown after the delayed start feature has been activated.

Press **STOP ON/OFF** keypad to return to the Cycle Menu. When there is sixty seconds left on the countdown, control will enter the Delayed Start Final Countdown Menu.

Delayed Start Final Countdown Menu

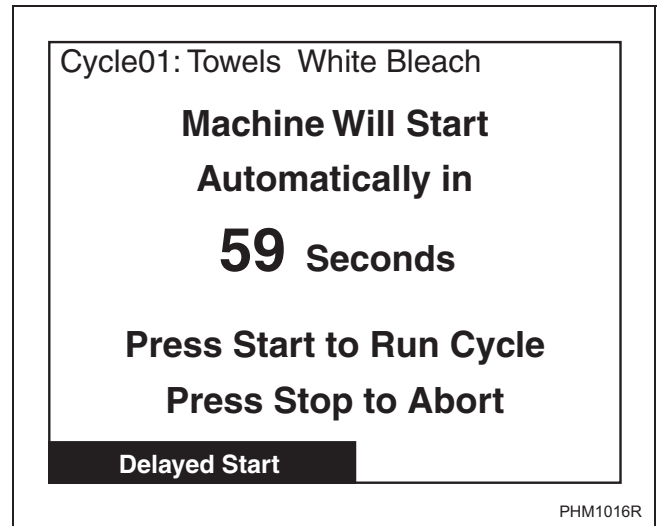

Figure 19

The Delayed Start Final Countdown Menu is displayed during the last sixty seconds before the control is automatically started. The audio signal will sound one second on and one second off.

The **START ENTER** keypad will start the selected cycle immediately. The **STOP ON/OFF** keypad will jump to the Cycle Menu.

Menu Navigation



The UniLinc

The front end control allows the user to control machine operation by pressing keypads to select options on the display menus and by navigating between display menus.

The control has four ways to navigate to program, edit, and select items in menus





Menu Navigation on a Single Screen





The Menu Navigation on a single screen displays a list of items arranged either left to right and/or top to bottom on the screen. A highlighted box shows the selected item in the menu. Press the directional arrow keypads to move the highlighted box between choices.

Press the  keypad to select an item. Press the  keypad to turn an item on or off.



NOTE: In Cycle Menu, the highlighted box remains in the center, and the cycles scroll as the directional keypads are pressed.

Menu Navigation with Parameters

Another type of menu similar is a menu with modifiable parameters. The  and  keypads are used to navigate through the screens. The  and  keypads are used to change the value of the highlighted item.



An example is the Temperature Menu under Global Setup. The menu items are positioned vertically, but the  and  keypads are used to navigate through the different items while the  and  keypads are used to adjust the values.

Screen to Screen Navigation using the Arrow Keypads



In Screen to Screen Navigation, the  or  keypad are used to go from one menu page to the next (i.e., moving from Alarms [1 of 3] Menu to Alarms [2 of 3] or Alarms [3 of 3] menus), if a menu cannot fit entirely on the same page. The Laundry Management Menu uses this navigation method.



Navigation in String Edit Mode

The String Edit Mode is used when a letter or numeric value has to be modified or created. The highlighted box is moved over the editable item and

the  keypad is pressed. The mode can be verified by seeing the first character in the item with a blinking underscore underneath. The character can then be changed by using the  and  keypads.

Press the  keypad to insert a space in place of the currently selected character.

For example, the Cycle Name can contain the capital letters “A” through “Z”, small letters “a” through “z”, the numbers “0” through “9”, and special characters. The user can go forward to the next character in the item by using the  keypad. Press the  keypad to go backward a character. If the first character in the item is selected and the  keypad is pressed, the cursor will go to the last character of the item. Thus, the cursor will move only within the item when the horizontal keypads are pressed.

Another example of the edit mode is when the user is programming the time. In the edit mode when programming a time, the only characters that can be selected are “0” through “9” when using the  or  keypad.

Display Screen Maps

Refer to the following charts for maps of all of the display menus.

System Menu Map Tree

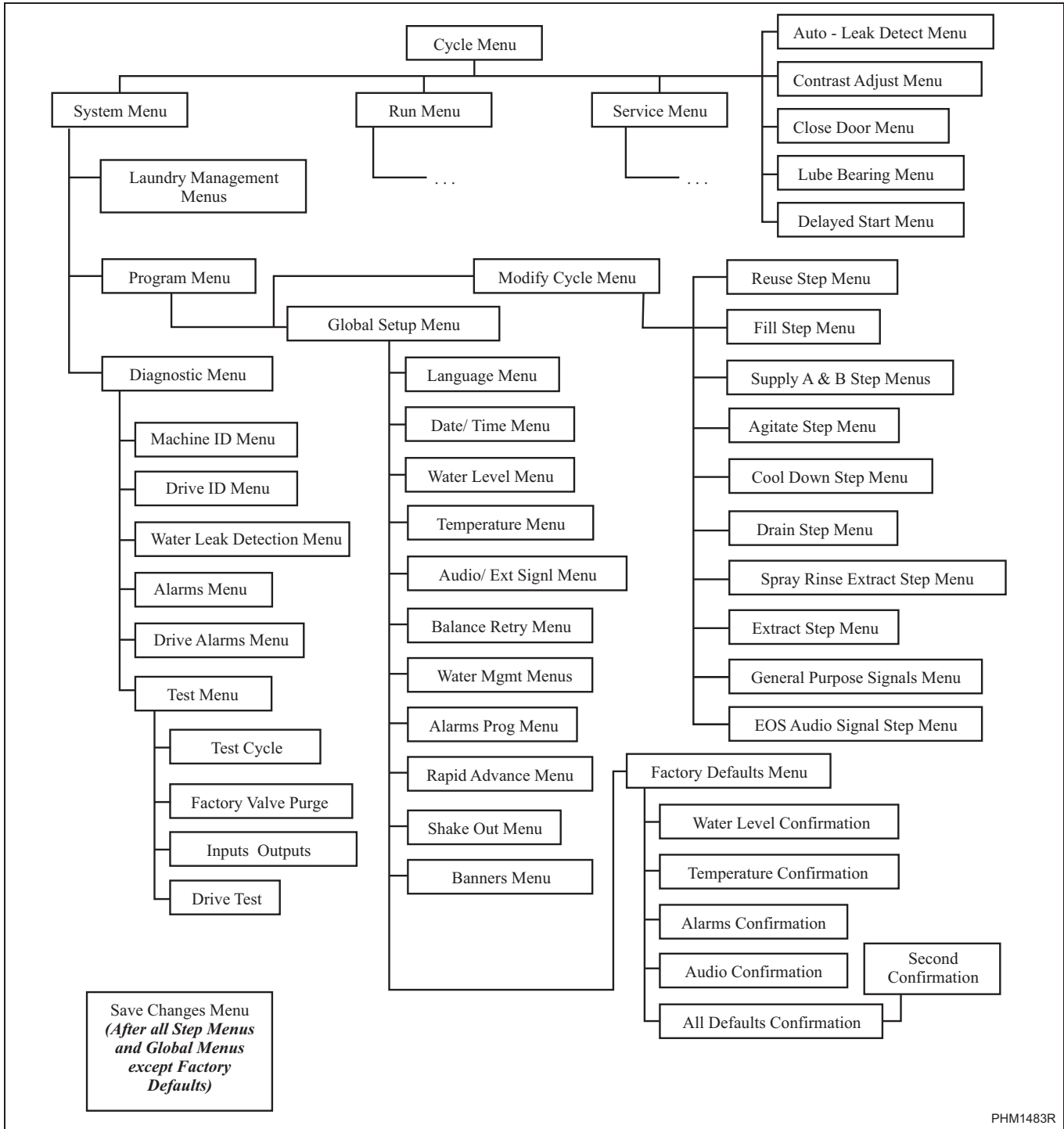

Figure 20

Run Menu Map Tree

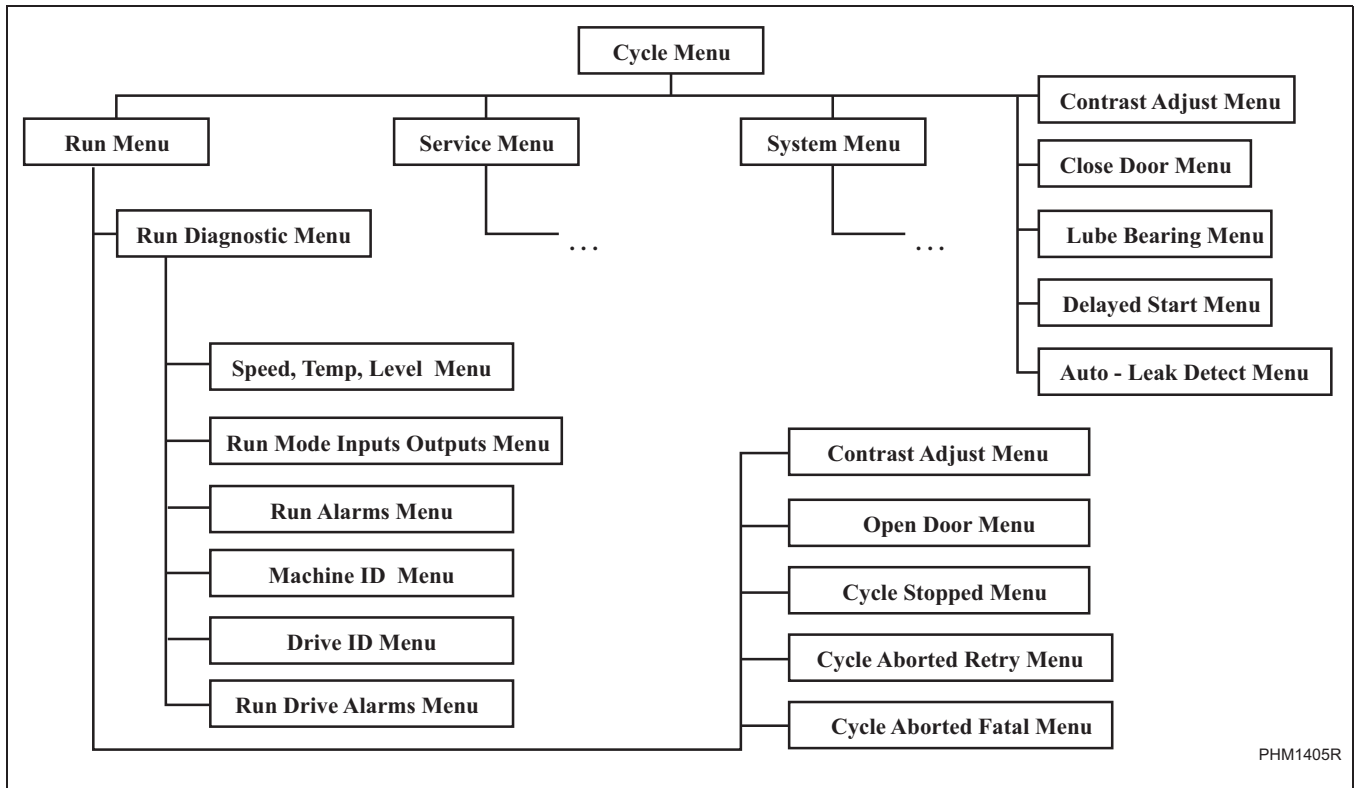

Figure 21

Service Menu Map Tree

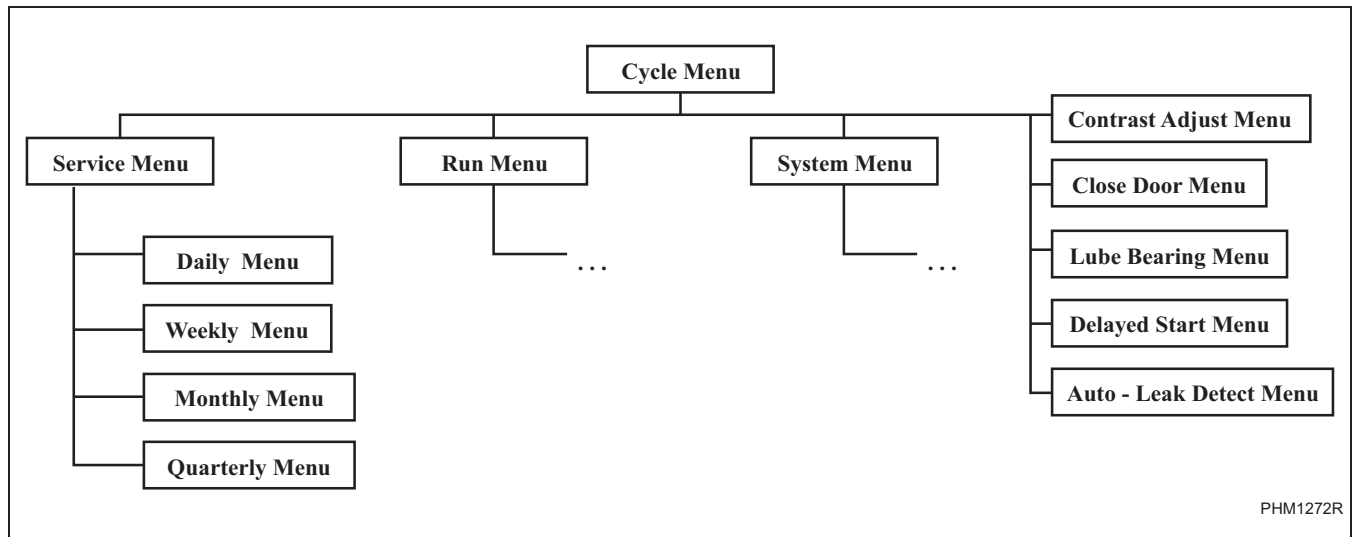

Figure 22

Programming UniLinc

System Menu

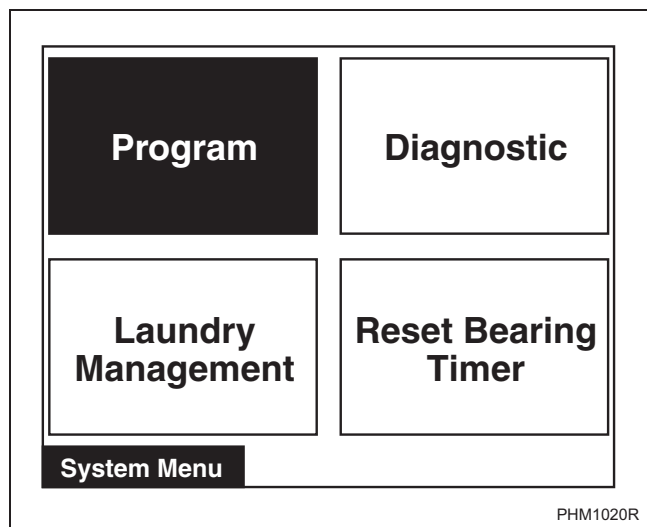

Figure 23

The System Menu allows the user to access: cycle programming, diagnostics, laundry management, bearing timer reset/reset bearing timer.

Press and hold **STOP ON/OFF**, then, **BACK**, then **LCD** to enter the System Menu.

The System Menu is a submenu of the Cycle Menu. The navigation of the System Menu is different from the Cycle Menu. In the Cycle Menu, the highlighted text box was stationary. In the System Menu, the ARROW keypads control the location of the highlighted text box. Text will remain at the same location but the highlighted box will move when the text box when the **←**, **→**, **LCD**, and **LCD** keypads are pressed.

Press the **START ENTER** keypad to enter selected menu.

Press the **BACK** keypad to return to the Cycle Menu screen.

If the user highlights Reset Bearing Timer and presses the **START ENTER** keypad, the text changes to Bearing Timer Reset and the control resets the total operation time since the bearings were last serviced. This menu item will not be an option on machines that do not have a greasable bearing.

Save Changes Menu

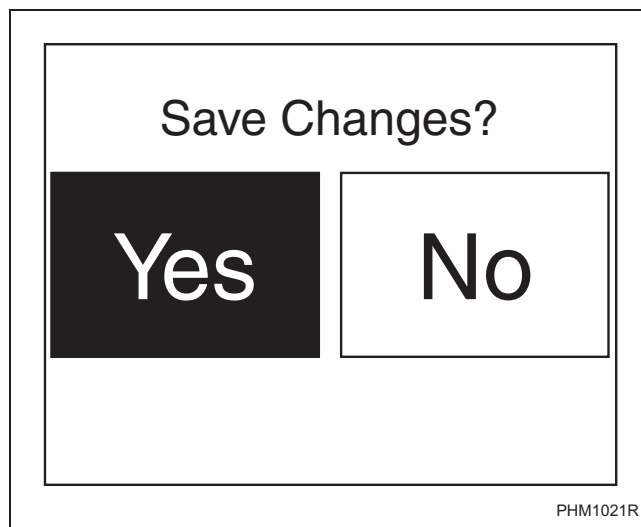

Figure 24

The Save Changes Menu is used to confirm programming changes when modifying a cycle or the parameters of the Global Settings. The Save Changes Menu will default to Yes. Using the **←** or **→** keypad will move the cursor between Yes or No. Press the **START ENTER** keypad to make a selection. Once the **START ENTER** keypad is pressed, the display will either return to the Modify Cycle Menu or the Global Setup Menu depending in which submenu the display was in.

Program Menu

Program Menu

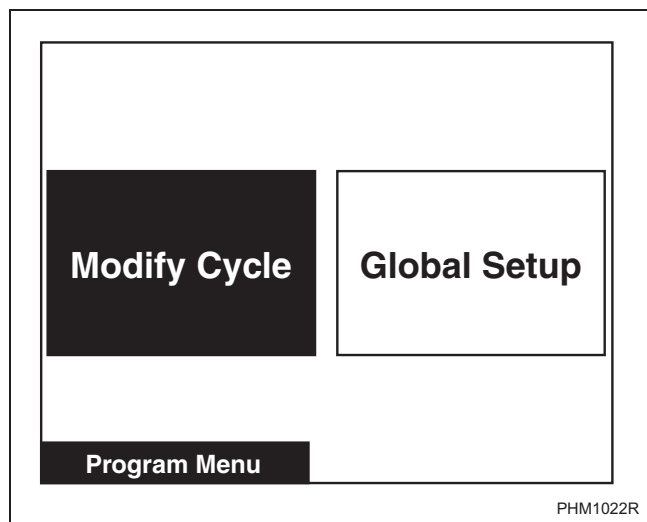





Figure 25

In System Menu, select Program and press .

To program cycles, select Modify Cycle and press .

To change properties that will affect the machine globally, select Global Setup (i.e., water temperature Cold to 35°F, will make the cold water temp 35°F for all cycles) and press .

Press the  keypad to return to System Menu.

Modify Cycle

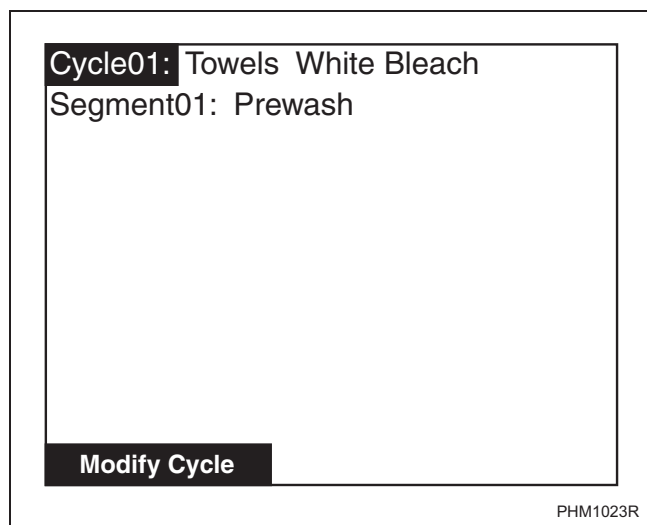



Figure 26

The Modify Cycle Menu is used to program the cycles. For programming steps, the Modify Cycle Menu changes to the Step Menu.

The Cycle Number will be highlighted when the Modify Cycle is first displayed.

Press the  or  keypad to change cycle selections.



The cycle can be turned on and off by pressing the  keypad. If the cycle is turned off, the Cycle Name will display “Off” and the user will not be able to make any changes to the cycle.



Press the  keypad to make the highlighted box move to the cycle name to the right of the cycle number.



Press the  keypad to make the display jump to the End of Segment (EOS) Audio Signal Step Menu of the last segment of that cycle which is programmed “On”.

NOTE: All segments and available steps have to be scrolled through even though they may be shut off. Figure 27 illustrates the flow of the cursor during the programming of a cycle.

To edit a cycle name, select the cycle name and press the  keypad.

The first character of the Cycle Name will have a blinking underscore underneath to display it is ready for editing. Use the  and  keypads to select the different characters. After the desired character has been selected, press the  keypad to save the character and move to the next character in the string.



The user may press the  keypad to go back a character. Pressing the  keypad when located on the first character will take the user to the last character of the string, which may be a blank space.

Continue pressing the  keypad to move to desired character. The blinking underscore is under the last character of the string and the  keypad is pressed, the blinking underscore will move to the first character of the string.

Press the  keypad to exit string edit mode.

Program Menu

NOTE: Refer to Table 2 for a chart of available letters, numbers and symbols.

Press the  keypad to move highlighted box to Segment Number or press the  keypad to move the highlighted box back to the Cycle Number. While the Segment Number is highlighted, the Segment Number can be turned on or off by using the  keypad. If turned off, all sub programming steps will become inaccessible.



Press the  or  keypad to change segment selections.

Press the  keypad to move the highlighted text box to the Segment Name.

While the Segment Name is selected, the user selects the Segment Name from a list of three choices by

pressing the  or  keypad. The Segment Name choices are Prewash, Wash, and Rinse.

NOTE: OFF may also be displayed in the Segment Name position if the segment number had been turned off previously, but is not a menu choice.

Press the  keypad to move highlighted box back to the Segment Number. Press the  keypad to move into step menus of cycle segment. Steps have separate menus (different screens) from the Modify Cycle Menu. However, when the highlighted cursor is on the Step Name and the  keypad is pressed, the display will jump back to the Modify Cycle Menu and the Segment Name will be highlighted.

Press the  keypad to jump to the Save Changes Menu.

Available Characters

A	B	C	D	E	F	G	H	I	J	K	L	M	N	O	P
Q	R	S	T	U	V	W	X	Y	Z	a	b	c	d	e	f
g	h	i	j	k	l	m	n	o	p	q	r	s	t	u	v
w	x	y	z	0	1	2	3	4	5	6	7	8	9	!	"
#	\$	%	&	'	()	*	+	,	-	.	/	:	;	<
=	>	?	@	[\]	^	_	`	{		}	~	€	,
f	„	…	†	‡	^	%	Š	<	Œ	Ž	‘	’	“	”	•
–	—	~	™	š	>	œ	ž	ÿ		ı	¢	£	¤	¥	
§	¨	©	ª	«	¬	-	®	¯	°	±	²	³	´	µ	¶
·	,	¹	º	»	¼	½	¾	¿	À	Á	Â	Ã	Ä	Å	Æ
Ç	È	É	Ê	Ë	Ì	Í	Î	Ï	Ð	Ñ	Ò	Ó	Ô	Õ	Ö
×	Ø	Ù	Ú	Û	Ü	Ý	Þ	ß	à	á	â	ã	ä	å	æ
ç	è	é	ê	ë	ì	í	î	ï	ð	ñ	ò	ó	ô	õ	ö
÷	ø	ù	ú	û	ü	ý	þ	ÿ							

Table 2

Cycle, Segment and Step Programming Flow Diagram

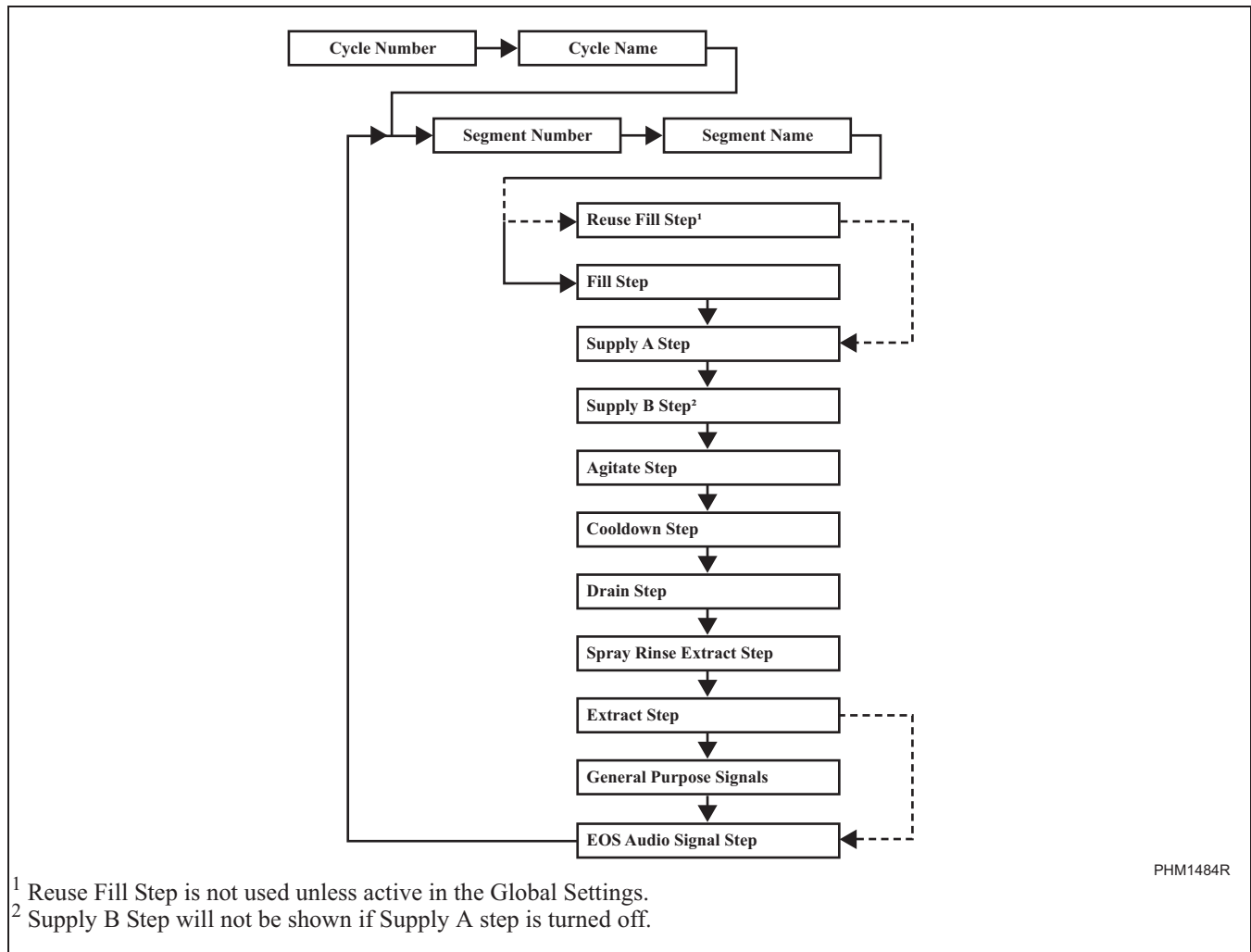

Figure 27

Step Menu Navigation

Step Menus are a subgroup of the Modify Cycle Menu and the navigation is very similar to the navigation of the Modify Cycle Menu. When a step menu is first displayed, the step name will be highlighted. While the step name is highlighted, it can be toggled on or off by pressing the **STOP ON/OFF** keypad. If the Step is toggled from OFF to ON, then the last programmed parameters will be displayed. The programmable parameters (i.e., water temperature, water level, time, etc.) are based on the step being programmed. For instance, the water temperature is available in the Fill Step but not the Reuse Fill Step, so, the water temperature parameter will not be shown in the Reuse Fill Step.

NOTE: Reuse Fill Step is only available when the different Step parameters can be selected.

Press the **◀** or **▶** keypad. To view all steps of a segment, continue pressing the **▶** keypad until the EOS Audio Step is displayed. Pressing the **▶** keypad again will take screen to Save Changes Menu. After selection, the cycle modify section is displayed with highlighted box on segment just viewed/changed. Pressing the **▲_{LCB}** or **▼** keypad can adjust the Step Name and parameters.

Program Menu

To adjust time, the user must press the **START ENTER** keypad to get to the Time Edit Mode. The Time Edit Mode works exactly like the String Edit Mode. The **▶** and **◀** keypads move the cursor between digits. The **▲_{LCD}** and **▼** keypads change the number.

To set parameters in the step menus, move highlight box to desired step parameter and press **START ENTER**, the **▲_{LCD}** and **▼** keypads to change values. In menus that do not have many values or items to choose from the vertical arrow keypads will toggle.

NOTE: To change a value, press the **▲_{LCD} or **▼** keypad every time a different item is to be selected.**

In menus that have many values or items, the user will be able to either toggle or slew the **▲_{LCD}** or **▼** keypad. Slewing the keypads is when the user holds down a keypad for a specified amount of time and the value automatically scrolls through the parameter being modified. The slewing is based on how much time the user holds down the keypad. If the keypad is held down for longer than 2 seconds the value will begin to scroll.

During the programming of a step, if the **BACK** keypad is pressed, the display will jump to the Save Changes Menu.

Reuse Fill Step Menu

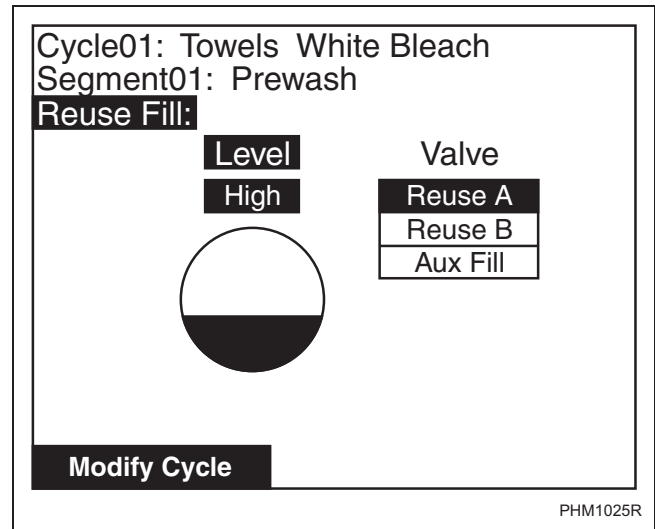

Figure 28

The Reuse Fill Step Menu is used to program the Reuse Fill step while modifying the Cycle. The Reuse Fill Step can only be viewed if the Water Reuse Parameter is turned on (refer to Global Setup Water Management section), and the fill step for the segment is turned off otherwise this step is skipped and not shown. The time for this step is fixed at 5 minutes. The Fill Alarm is not active for this step. However, the control will energize cold fill and spray after five minutes until the water level reaches the programmed level.

The first programmable parameter of the Reuse Fill step is the water level. The target water level is either the programmed global value (High, Medium or Low) or a specific water level value. Global water level values are set in the Water Level Menu (refer to Global Setup, Water Level). For the specific water level value, 1-30 may be selected. The water level can be changed using the **▲_{LCD}** and **▼** keypads.

The parameter after water level is valve selectors. Reuse Fill A, Reuse Fill B, or both may be activated during the Reuse Fill step. The valve can be selected and deselected by pressing the **STOP ON/OFF** keypad. If Reuse Fill A and Reuse Fill B are deactivated, Aux Fill will activate by default. If Water Reuse is enabled, the Aux Fill will be on by default.

Press the **BACK** keypad to return to Save Changes Menu.

Fill Step Menu

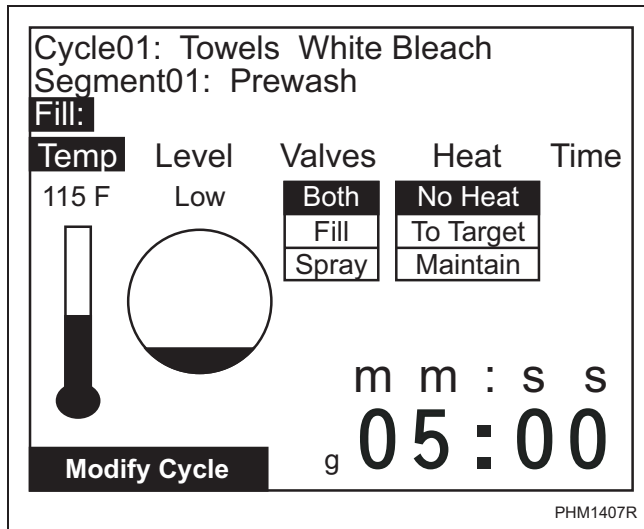

Figure 29

The Fill Step Menu is used to program the fill step. The Fill Step contains the parameters the machine will use when it fills.

Water temperature can be either a global value or a specific temperature. The global settings are Cold (COLD), Warm (WARM), or Hot (HOT). The values for these global settings are set in the Global Setup Temperature Menu. The specific temperature selection can either be in Celsius or Fahrenheit depending on which is chosen in the Global Setup.

The water level can be set to a global value, a specific level from 1 to 30, or to overflow (OVFL). The global settings are Low (LOW), Medium (MED), or High (HIGH).

The valves used to fill can be selected individually. The valve settings are Fill, Spray or Both.

NOTE: Advance Options must be enabled in the Water Management Menu in Global Setup to program the valves used during a fill.

The next parameter controls the heater while the machine is actually in the Agitate Step. This parameter is only displayed if a heater is present.

There are three choices on heater equipped machines. The choices are “No Heat”, “To Target”, and “Maintain”. If “No Heat” is selected, the heater will not function during the Agitate Step. If “To Target” is enabled, the heater will turn on in the Agitate Step and reach the desired water temperature. Once the desired water temperature is reached the heater shuts off. If “Maintain” is selected, the heater is turned on and off as necessary throughout the Agitate Step to maintain the desired water temperature.

The time that is programmed refers to the Fill Alarm Time. If the time is set to the global Fill Alarm Time, a “g” will be displayed to the left of the time. The time can be changed to a specific value for an individual cycle by entering Time Edit Mode, using and

keypads to navigate between minutes and

seconds, and and keypads to change the time. The Fill Alarm Time is the amount of time allowed for fill to complete. If fill is not reached by Fill Alarm Time, the control will enter Error Mode.

The Reuse Fill Step and Fill Step cannot both be enabled in the same segment. If the Reuse Fill Step is enabled then the Fill Step will be turned off.

Press the keypad to enter the Save Changes Menu.

Program Menu

Heater Option

If a Heater is present it can be programmed to heat water during an Agitate cycle step. The Fill step of a cycle segment contains the Heater programming options for that segment. If the Heater is programmed to On in the Fill step of a segment, the Heater is turned on during the Agitate cycle step in order to heat the water to the target temperature specified by the programming information of the segment's Fill step.

The target temperature can be programmed for the segment in one of two ways. The Fill Step can be programmed to use the Hot, Warm or Cold Global temperature value. The Fill step can also be programmed to a water temperature specific to this segment. During the initial heater on time, the remaining cycle time count-down will pause until the target temperature is reached. If the heater is turned on for more than the Global Heater Alarm time and the desired temperature is not reached, the heater is turned off and the Cycle Stopped Error Menu is displayed prompting for user input. The Heater Error is logged. The user may either abort or continue the cycle. If the Fill Step for this segment is programmed to maintain the heated water temperature, the heater will be turned back on in the Agitate step any time the water temperature has fallen more than five (5) degrees F below the programmed target temperature. If the water level ever falls below the programmed water level, the heater will be turned off until the programmed water level is reached again.

Supply A and B Step Menu

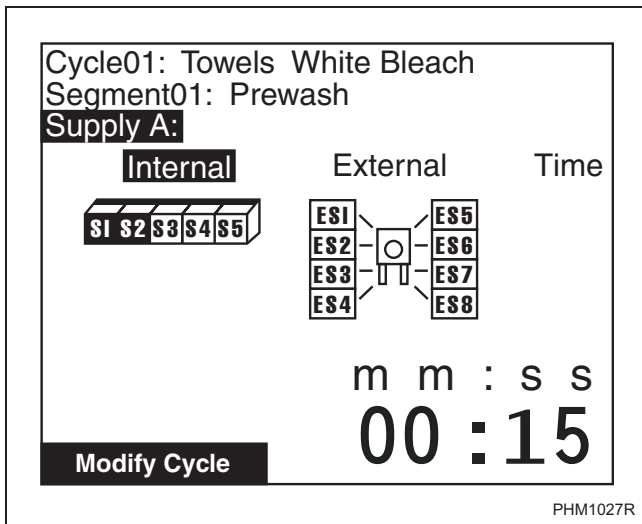

Figure 30

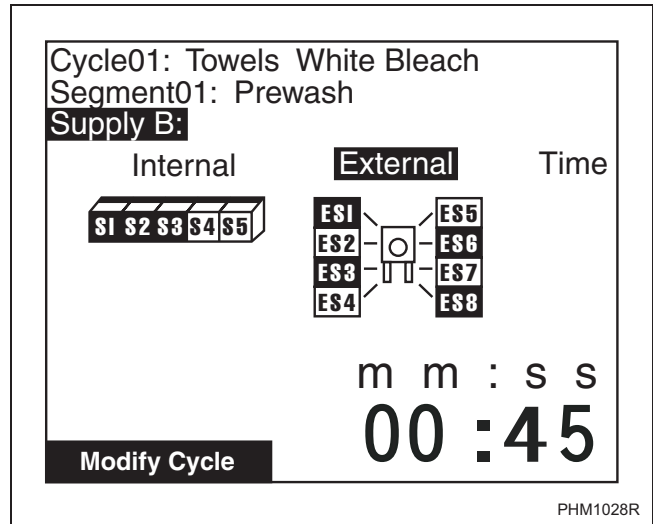

Figure 31

The Supply A and Supply B Step Menus are used to control which supply or supplies that are activated during a Segment and the duration of the dispensing. The Internal Supplies are listed from S1 to S5 and external supplies are numbered ES1 through ES8. Any of the internal, external, or both type of supplies can be turned on or off during Supply Step A or Supply Step B. Any combination of SUPPLIES is possible in both menus.

The and keypads are used to move the cursor to the different parameters and Internal Supplies 1 through 5. The and keypads are used to move the cursor to the External Supplies 1 through 8. Once a supply has been chosen, it is selected by pressing the keypad. The supply is activated if it is highlighted. The time can be edited for each supply step by moving the highlighter box to time. Press . Blinking underline indicates the number is ready to be changed.

Pressing the keypad will jump to the Save Changes Menu.

Agitate Step Menu

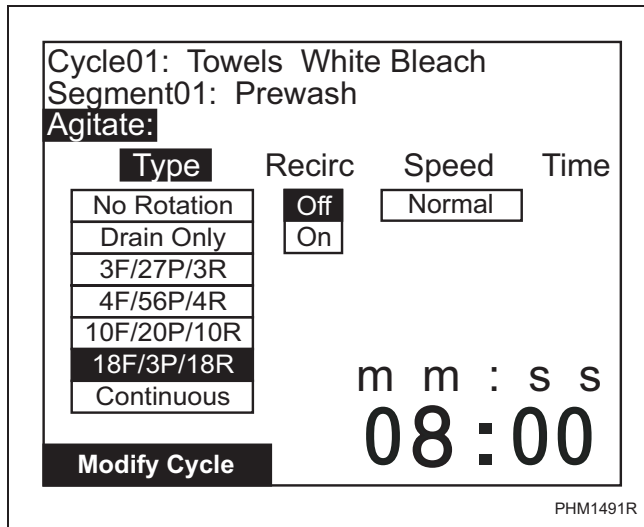

Figure 32

The purpose of the Agitate Step Menu is to program the parameters used while the machine is performing the Agitate Step. The Agitate cycle step can be turned on or off. The type of agitation is the first available parameter. The agitation type parameter menu has seven (7) choices with 18F/3P/18R (18 seconds forward, 3 seconds pause, and 18 seconds reverse) being the default.

The recirculation parameter controls the operation of the recirculation pump during machine operation. The user can either turn it on or off. If the water recirculation option is not enabled in Global Setup parameter, then this parameter will not display. The Wash speed can be programmed to either Normal Wash speed, Reduced Wash speed or a specific RPM from 10-50.

The Agitate step can be programmed to a time from one (1) minute to 30 minutes.

NOTE: If the Agitate type is programmed to a value of “No Rotation”, the cycle step time can be programmed to a value from one (1) minute to 24 hours.

Pressing the **BACK** keypad will jump to the Save Changes Menu.

Cool Down Step Menu

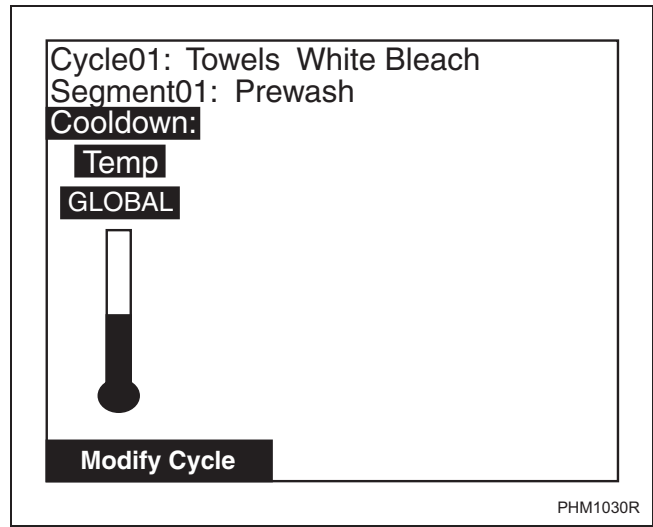

Figure 33

The Cool Down Step Menu gives the user the option to set the Cool Down Option after the Agitation Step. The Cool Down cycle step can be turned on or off. If turned off, the control will advance to the next cycle step (Drain).

The temperature setting allows the user to set the Cool Down temperature of the water after the Agitation Step has ended. The temperature will default to cool down temperature set in Global Setup. To change cool down temperature, press the **▲** and **▼** keypads.

Press the **BACK** keypad to jump to the Save Changes Menu.

Program Menu

Drain Step Menu

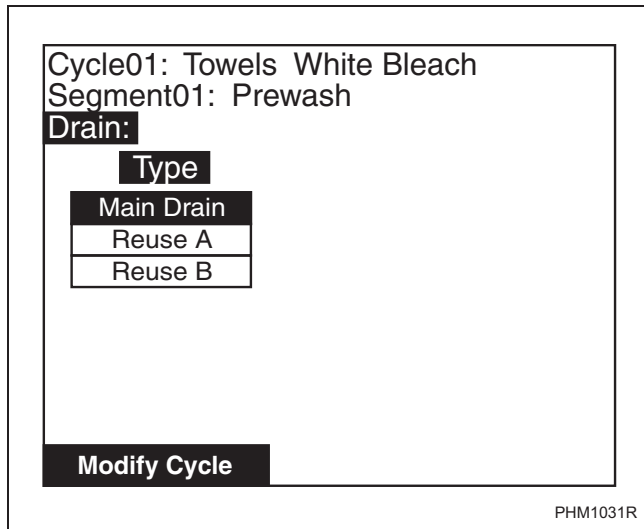

Figure 34

The Drain Step Menu allows the user to activate or deactivate the drain step and control where the water is drained. The Drain cycle step can be turned on or off by pressing the **STOP ON/OFF** keypad. If turned off, the menu will show that the Spray Rinse Extract and Extract Steps are unavailable for that cycle segment.

If global water reuse is enabled the drain type allows the user the option of pumping the wash water to Reuse A or Reuse B or sending it to the Main Drain. If global water reuse is disabled the screen will show Main Drain only. Using the **START ENTER** keypad to select Type, press the **▲ LCD** or **▼** keypad to select the drain type. If the Drain Step is turned off, then the Type parameter menu will not be present and the text “Extract steps are disabled” will be displayed. With the Drain Step disabled, the next available segment step would be the EOS Audio Signal Menu.

Press the **BACK** keypad to jump to the Save Changes Menu.

Spray Rinse Extract Step Menu

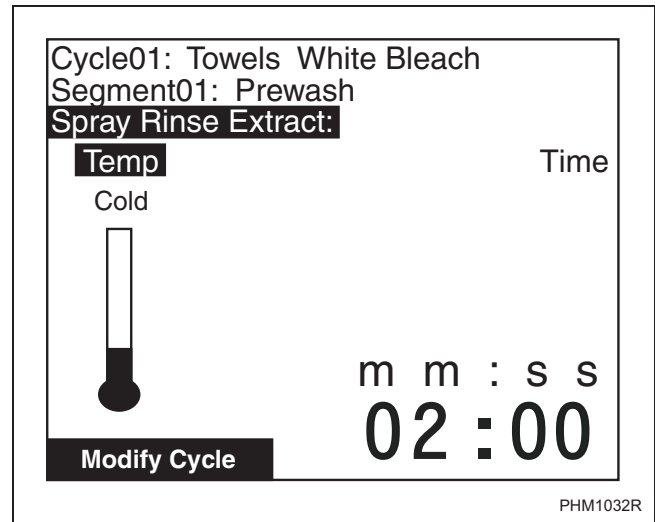

Figure 35

The Spray Rinse Extract Step Menu is used to program the temperature and time for the Spray Rinse Extract Step. The Spray Rinse Extract cycle step can be turned on or off with the **STOP ON/OFF** keypad. If turned off, the control will advance to the next available cycle step. If Spray Rinse Extract option is not available for the machine, the step will be skipped and control will advance to Extract Step Menu.

The temperature is programmed by selecting the Temp parameter and then using the vertical keys to change the thermometer to Cold, Warm or Hot. The Spray Rinse Extract time is programmed by moving the highlight box to Time. Press **START ENTER**. Blinking underline is located in character ready to be changed. Use **▲ LCD** and **▼** keypads to change number as desired.

Pressing the **BACK** keypad will jump to the Save Changes Menu.

Extract Step Menu

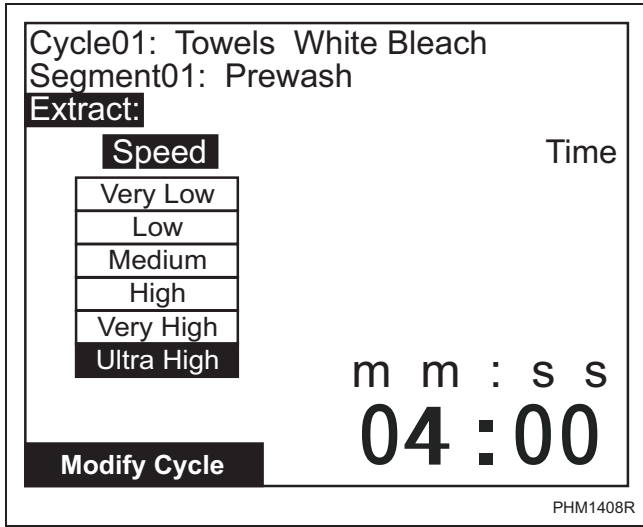

Figure 36

The Extract Step Menu is used to program the motor speed and time for the Extract Step. The Extract Step can be turned on or off by using the **STOP ON/OFF** keypad. If turned off, the control will advance to End of Segment Audio Signal step.

NOTE: If Advance Options are enabled in the Water Management Menu, the next option will be General Purpose Signals Menu.

To choose a motor speed, press **START ENTER** while selecting Speed and use the **▲ LCD** and **▼** keypads to make a selection. The motor speed is selected from the menu bar. The Extract time can be programmed by moving highlighted box to Time. Press **START ENTER**. Blinking underline will indicate number to change. Use the **▲ LCD** and **▼** keypads to change numbers.

Press the **BACK** keypad to jump to the Save Changes Menu.

General Purpose Signals Menu

The General Purpose Signals Menu is used to program external supply Signals (ES5-ES8) during each segment's Reuse Fill, Fill, Agitate, Cooldown, Drain, Spray Rinse Extract and Extract Steps. To choose a step, press the **◀** and **▶** keypads and press the **START ENTER** keypad. Use the **◀** and **▶** keypads to move the cursor to the desired external supply signal and press the **STOP ON/OFF** keypad to select external supply signal. Press the **START ENTER** keypad. Press the **BACK** keypad to jump to the Save Changes Menu.

NOTE: To access the General Purpose Signals Menu, the Advance Options must be enabled in the Water Management Menu in Global Setup.

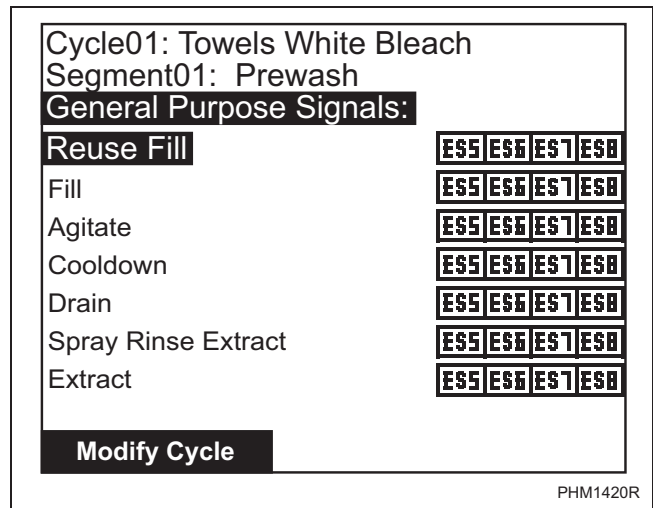

Figure 37

Program Menu

End of Segment Audio Signal Step Menu

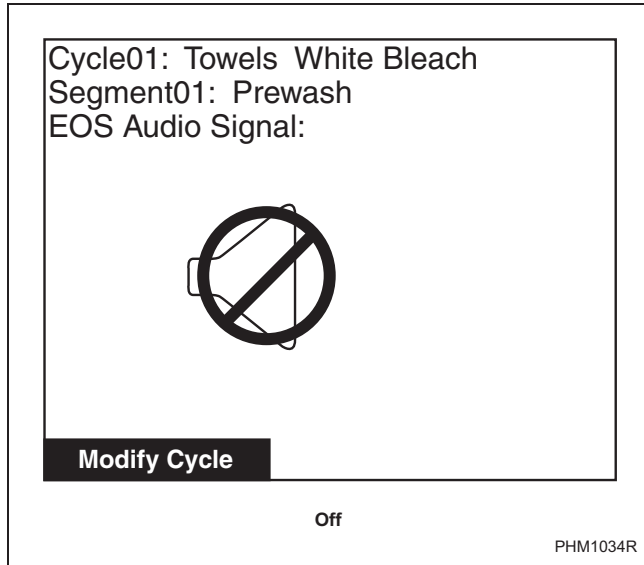

Figure 38

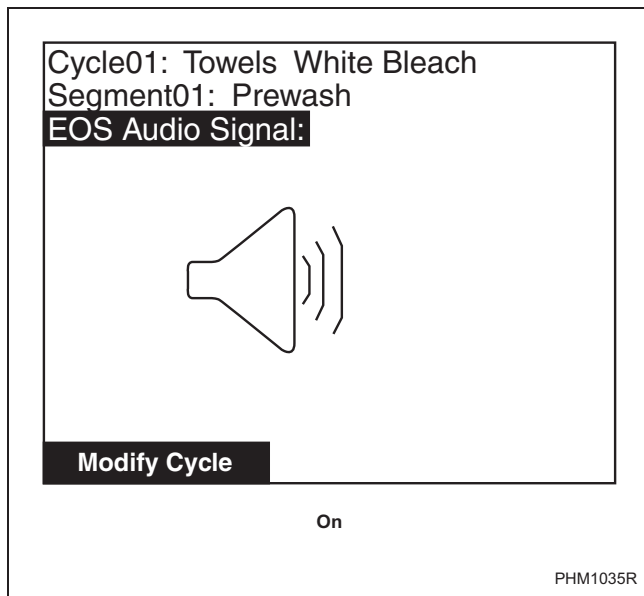

Figure 39

The End of Segment (EOS) Audio Signal Step Menu allows the user to set whether an audio signal is activated at the end of a segment. The End of Segment Audio Signal step can be turned on or off with the **STOP ON/OFF** keypad. If turned off, the control will advance to the next cycle step (start of the next segment, or the end of the cycle).

Press the **BACK** keypad to enter the Save Changes Menu.

Global Setup

Global Setup Menu

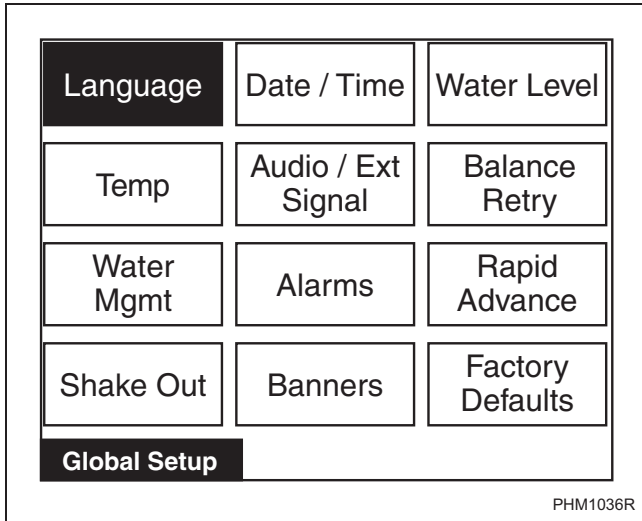

Figure 40

The Global Setup Menu allows the user to make changes to global properties of the machine. Use the , , , and keypads to navigate the menu. Select a menu item by pressing the keypad. Press the keypad to enter the Program Menu.

Language Menu

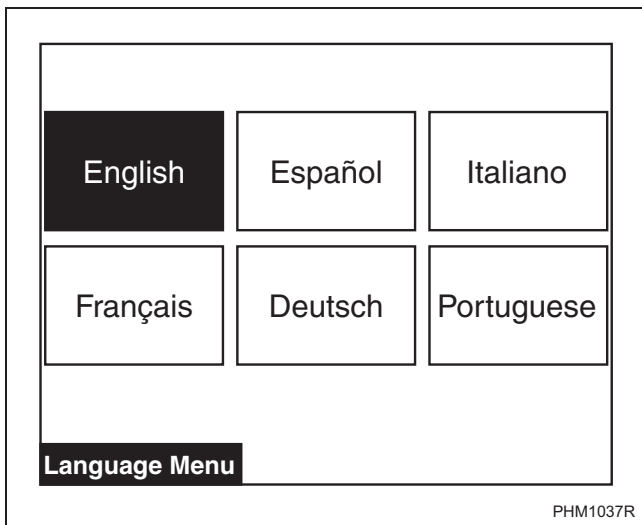

Figure 41

The Language Menu is used to select the language displayed. The user can choose English, Spanish, Italian, French, German or Portuguese.

Press the , , , or keypad to move the highlighted box through the different selections. English is the default language.

NOTE: Menus related to cycle operation and service are the only menus that will display in the chosen language if English is not selected. All System Menu sub-menus will remain in English.

Press to select a language. The Save Changes Menu will display.

Press or to move highlighted box to “Yes” or “No”.

Press the keypad to return to Global Setup Menu. If no changes were made, press the keypad to return to Global Setup Menu.

Date/Time Menu



Figure 42

The Date/Time Menu is used to set the date, day of the week, time, and daylight saving option.

Press and keypads to move the highlighted box through the different items in the menu. Once the item is highlighted, the value can be changed by using the and keypads. The Save Changes Menu will display. Use or to move highlighted box to “Yes” or “No”.

Global Setup

Press the **START ENTER** keypad to return to Global Setup Menu. If no changes were made, press the **START ENTER** or **BACK** keypad to return to Global Setup Menu.

The control's Clock will automatically adjust for leap-year. The control may be programmed for automatic daylight saving adjustment. If the Daylight Saving option is disabled, no adjustment takes place. If it is enabled, on the second Sunday in March, the time will spring forward from 1:00 AM to 2:00:00 AM. On the first Sunday in November, the time falls back from 2:00:00 AM to 1:00:00 AM.

Daylight Saving can be enabled or disabled by moving highlighted box to Daylight Saving and pressing **BACK** or **▼** to Yes or No. The Save Changes Menu will display. Use **◀** or **▶** to move highlighted box to "Yes" or "No". Press **START ENTER** keypad to return to Global Setup Menu. If no changes were made, press **START ENTER** or **BACK** keypad to return to Global Setup Menu. The factory-default value for daylight saving is enabled.

Water Level Menu

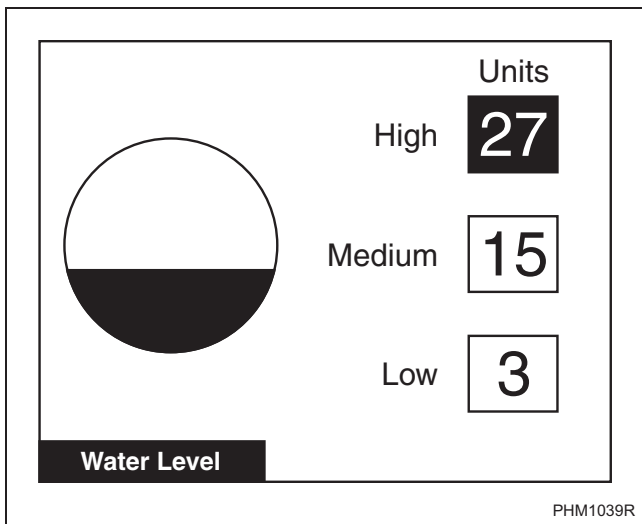

Figure 43

The Water Level Menu sets the different global water level settings. The value of the water level is a percentage of the machine maximum water level, which is in 30 equal parts or levels. In the 30 different settings, the image will contain three different regions. The regions are found in *Table 3*.

Water Level	Value
Low (20%)	01-10
Medium (30%)	11-20
High (40%)	21-30

Table 3

The water level settings will apply to all cycles that are programmed using low, medium or high in the water level setting.

The **◀** and **▶** keypads are used to move the highlighted box through the different items in the menu. Once the item is highlighted, the value can be changed by using the **▲** and **▼** keypads. The Save Changes Menu will display. Use **◀** or **▶** to move highlighted box to "Yes" or "No".

Press **START ENTER** keypad to return to Global menu. If no changes were made, press **START ENTER** or **BACK** keypad to return to Global Setup Menu.

Temperature Menu

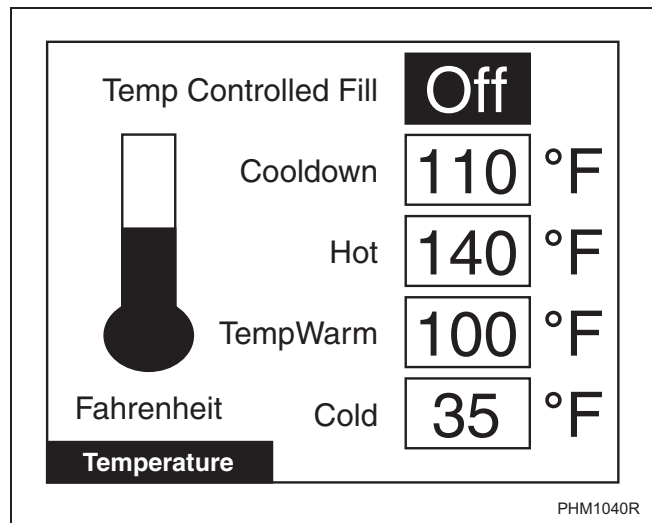

Figure 44

The Temperature Menu sets the different global temperature settings. The unit of the temperature can be changed between Fahrenheit and Celsius. The temperature settings will apply to all cycles that are programmed using COLD, WARM, and HOT in the temperature setting. The Temperature Controlled Fill option will allow the user, with a temperature sensor present, to choose whether to run the machine with Temperature controlled Fill On or Off.

Press and keypads to move the highlighted box through the different items in the menu. Once the item is highlighted, press the and keypads to change the values.

Press the or keypad to jump to the Save Changes Menu.

Use or to move highlighted box to “Yes” or “No”.

Press the keypad to return to Global Setup Menu. If no changes were made, press the or keypad to return to Global Setup Menu.

Audio Menu

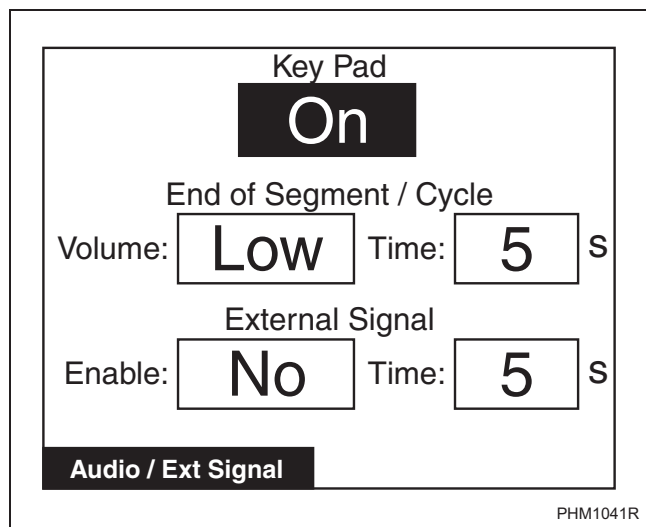

Figure 45

The Audio/External Signal Menu sets the audio options of the keypad audio feedback, the beeper volume and the External Signal.

Press the and keypads to move the highlighted box through the different items in the Audio Menu.

Once the item is highlighted, press the and keypads to change the value. Press the or keypad to return to the Save Changes Menu if changes were made.

Press the or keypad to move highlighted box to “Yes” or “No”. Press keypad to return to Global Setup Menu. If no changes were made, press or keypad to return to Global Setup Menu.

Balance Retry Menu

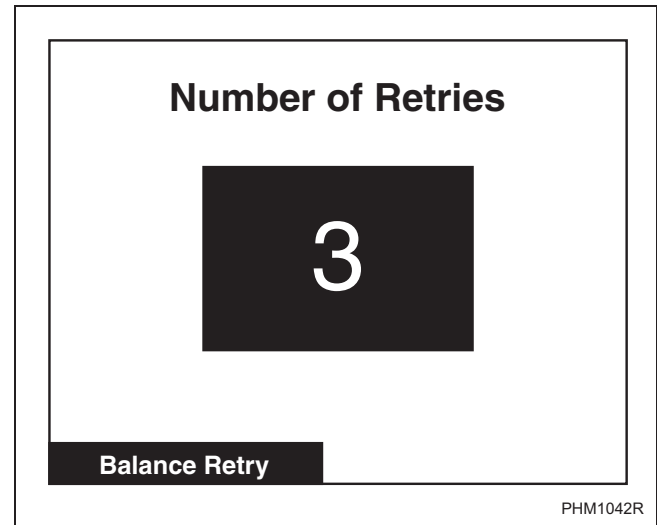

Figure 46

The Balance Retry Menu sets the option of how many retries the machine will attempt to rebalance a load before an alarm is set. The user will be able to select a value from one (1) to seven (7).

Press the or keypad to change number of balance retries.

Press the or keypad to jump to the Save Changes Menu. Press the or keypad to move highlighted box to “Yes” or “No”.

Press the keypad to return to Global Setup menu. If no changes were made, press or keypad to return to Global Setup Menu.

Water Management Menu

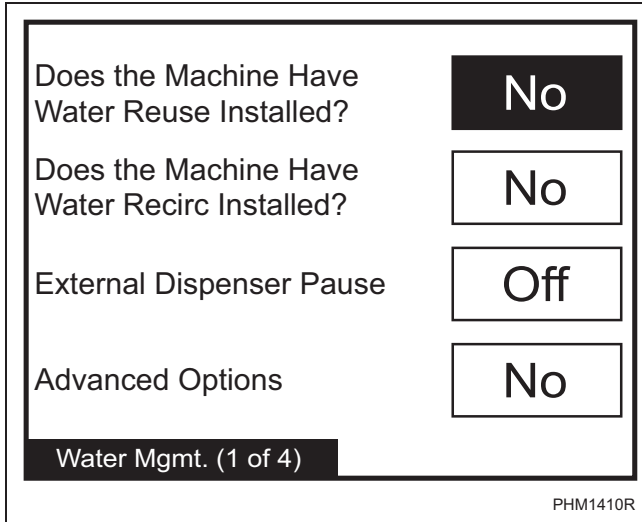

Figure 47

The Water Management 1 Menu allows the user to set the water reuse and water recirculation options to Yes or No. If water reuse option is turned off, the Reuse Fill Menu will not be displayed during programming of a Segment. Press the and keypads to move the highlighted box through the different items in the Water Management 1 Menu. Press the or keypad to change selections to “Yes” or “No”.

The user can set the External Dispenser Pause On or Off. The control default for this option is “Off”. If programmed on, the control will wait with a normally open contact for contact closure to indicate the need for a pause in cycle operation.

The user can set the Advance Options in the Water Management Menu to Yes or No. The control default for this option is “No.” If programmed Yes, the Valves Option is enabled in the Modify Cycle Fill Step Menu and enables Modify Cycle General Purpose Signals Menu during programming of a cycle.

Press the or keypad to jump to the Save Changes Menu. Use or to move highlighted box to “Yes” or “No”.

Press the keypad to return to Global Setup Menu. If no changes were made, press or keypad to return to Global Setup menu.

To view Water Management 2 Menu, press keypad while the “External Dispenser Pause” textbox is highlighted/

To view Water Management 4 Menu, press keypad while the “Does the Machine Have Water Reuse Installed?” textbox is highlighted.

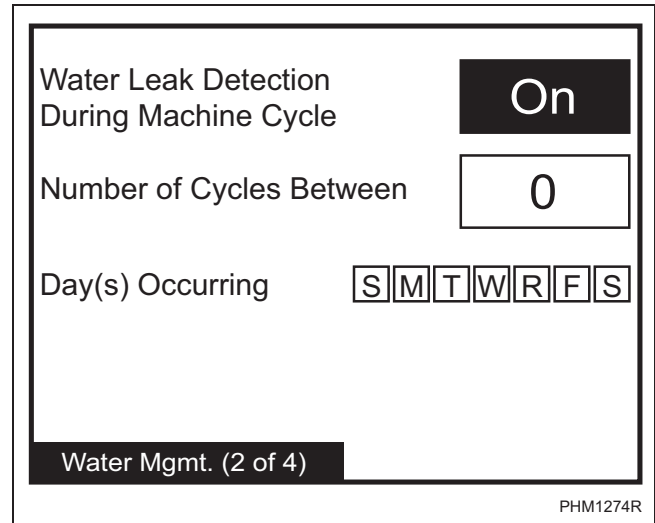

Figure 48

The Water Management 2 Menu allows the user to enable or disable the Water Leak Detection During Machine Cycle parameter. Once Water Leak Detection is enabled, the Number of Cycles Between and the Day(s) Occurring parameters can be changed.

Press the and keypads to move the highlighted box through the parameters of the Water Management 2 Menu. Press the or keypads to change the Water Leak Detection During a Machine Cycle and Number of Cycles Between parameters’ values. Press the keypad to change the Day(s) Occurring parameter’s values.

Press the or keypad to jump to the Save Change Menu. Use or to move highlighted box to “Yes” or “No”.

Press the to return to Global Setup Menu. If no changes were made, press or keypad to return to Global Setup menu.

To view Water Management 3 Menu, press keypad until the menu is displayed.

To view Water Management 1 Menu, press keypad while Water Leak Detection During Machine Cycle textbox is highlighted.

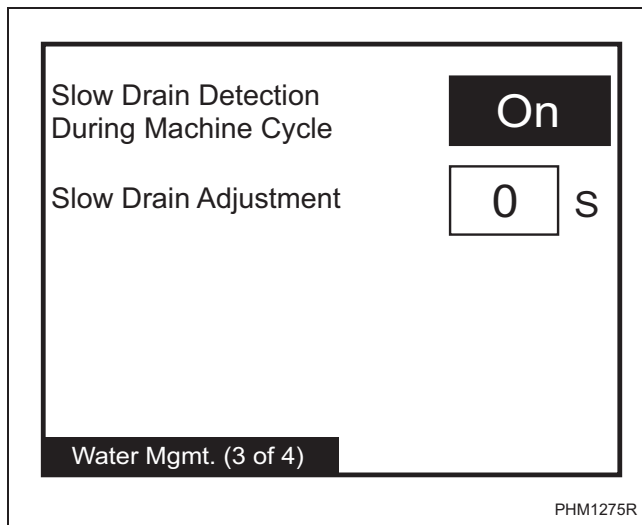

Figure 49

The Water Management 3 Menu allows the user to enable or disable the Slow Drain Detection During Machine Cycle parameter. Once Slow Drain Detection is enabled, the Slow Drain Adjustment parameter can be changed.

Press the and keypads to move the highlighted box through the parameters of the Water Management 3 Menu. Press the or keypads to change the values of the parameters.

Press the or keypad to jump to the Save Change Menu. Use or to move highlighted box to “Yes” or “No”.

Press the to return to Global Setup Menu. If no changes were made, press or keypad to return to Global Setup menu.

To view Water Management 4 Menu, press keypad until the menu is displayed.

To view Water Management 2 Menu, press keypad while Slow Drain Detection During Machine Cycle textbox is highlighted.

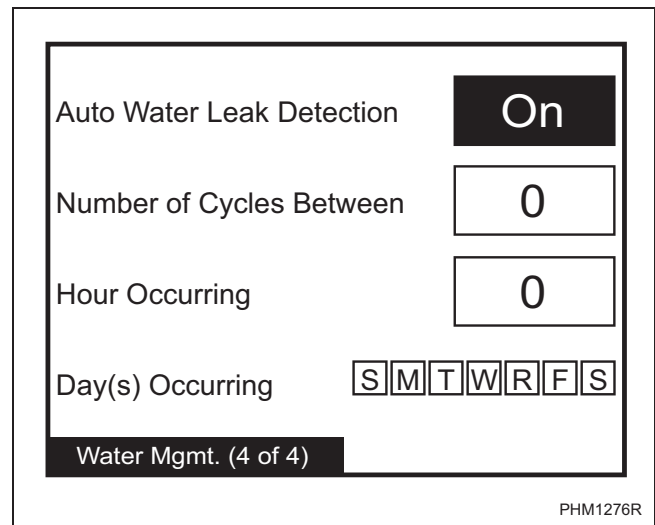

Figure 50

The Water Management 4 Menu allows the user to enable or disable the Auto-Water Leak Detection parameter. Once Auto-Water Leak Detection is enabled, the Number of Cycles Between, Hour Occurring and Day(s) Occurring parameters can be changed.

Press the and keypads to move the highlighted box through the parameters of the Water Management 4 Menu. Press the or keypads to change the values of the Auto-Water Leak Detection, Number of Cycles Between and Hour Occurring parameters' values. Press the keypad to change the value of the Day(s) Occurring parameter.

Press the or keypad to jump to the Save Change Menu. Use or to move highlighted box to “Yes” or “No”.

Press the to return to Global Setup Menu. If no changes were made, press or keypad to return to Global Setup menu.

To view Water Management 1 Menu, press keypad until the menu is displayed.

To view Water Management 3 Menu, press keypad while Auto-Water Leak Detection textbox is highlighted.

Alarms Program Menu

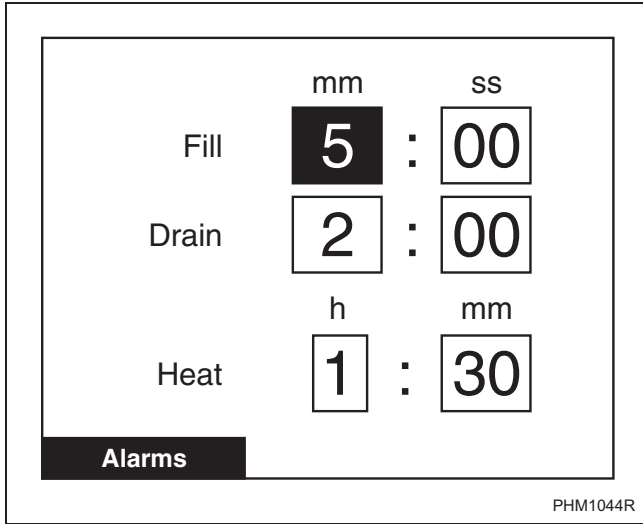

Figure 51

The Alarms Program Menu is used to set the fill, drain, and heat alarm times.

The and keypads are used to move the highlighted box through the different items in the Alarm Program Menu. Once the item is highlighted, the value can be changed by using the and keypads. Pressing the or keypad will jump to the Save Changes Menu. Use or to move highlighted box to “Yes” or “No”. Press the keypad to return to Global Setup menu. If no changes were made, press the or keypad to return to Global Setup Menu.

Rapid Advance Menu

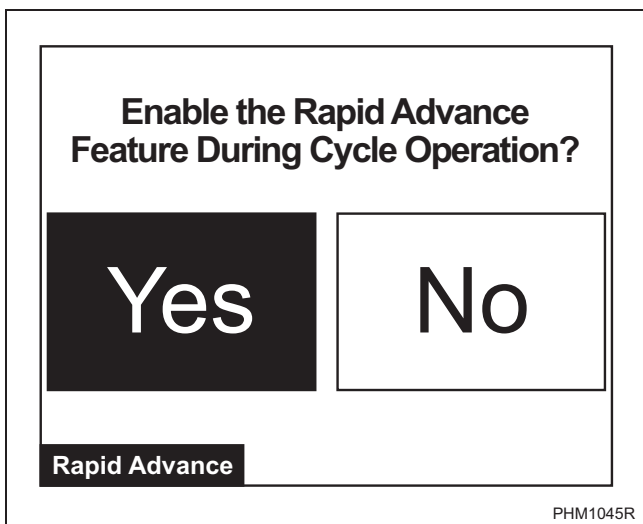

Figure 52

The Rapid Advance Menu has the option of whether the user will be able to rapid advance through steps while the machine is operating. Press the or keypad to change the selection. All the keypads have the same effect and will toggle the selection between on or off. Press the or keypad to jump to the Save Changes Menu. Use or to move highlighted box to “Yes” or “No”. Press keypad to return to Global Setup Menu. If no changes were made, press the or keypad to return to Global Setup Menu.

If the Rapid Advance Option is enabled, the user can advance a running machine cycle with presses of the keypad. When the keypad is pressed, the control will immediately show the next cycle step in the Run Menu but will not change the outputs for a period of at least five (5) seconds. The user may advance into any cycle step except the Spray Rinse Extract and Extract Steps. If the control is executing a Drain step and the user presses to execute a Rapid Advance, the control will skip over the Extract Step. When the cycle is completed, the audit counter, Total Rapid Advance Cycles is incremented rather than the Total Machine Cycles audit counter. In addition this cycle is recorded in the audit list “Last 25 Machine Cycles Completed” and the audit list “Last 10 Machine Cycles Rapid Advanced/Aborted.” Refer to *UniLinc PC and PDA Application User Instructions* for additional information on using a PC/PDA.

In the Run Menu, the total remaining cycle time is reduced by the corresponding advance step time if programmed. If the Rapid Advance Option is disabled preventing a manual Rapid Advance, the user may still execute a Rapid Advance using the PC/PDA through the network.

Shakeout Menu

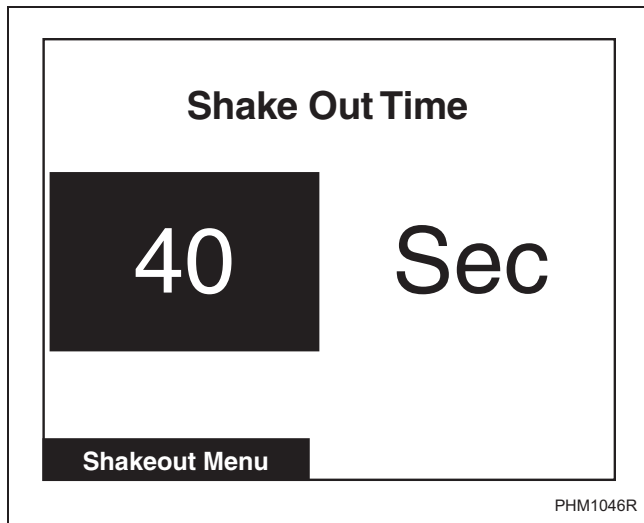











Figure 53

The Shakeout Menu is used to set the Shakeout time after the Extract Step. The  and  keypads adjust the time. The time can be set from 0-120 seconds in increments of 20 seconds.

Press the  or  keypad to enter the Save Changes Menu. Press  or  to move highlighted box to “Yes” or “No”. Press the  keypad to return to Global Setup Menu. If no changes were made, press the  or  keypad to return to Global Setup Menu.

Banners Menu

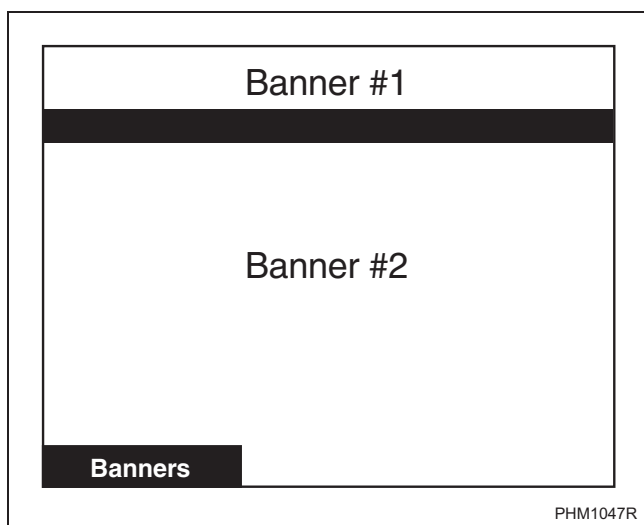











Figure 54

The Banners Menu is used to create or modify the banners that are displayed while the machine is on the Cycle Menu. The banners are displayed at the top of the screen.

The banners are created or modified using the String Edit Mode. Refer to Program Menu, Modify Cycle section. Use the  or  keypad to highlight the different lines and press the  keypad to edit the string. Pressing the  keypad will jump to the Save Changes Menu. Use  or  to move highlighted box to “Yes” or “No”. Press the  keypad to return to Global Setup Menu. If no changes were made, press the  or  keypad to return to Global Setup Menu.

Factory Defaults Menu

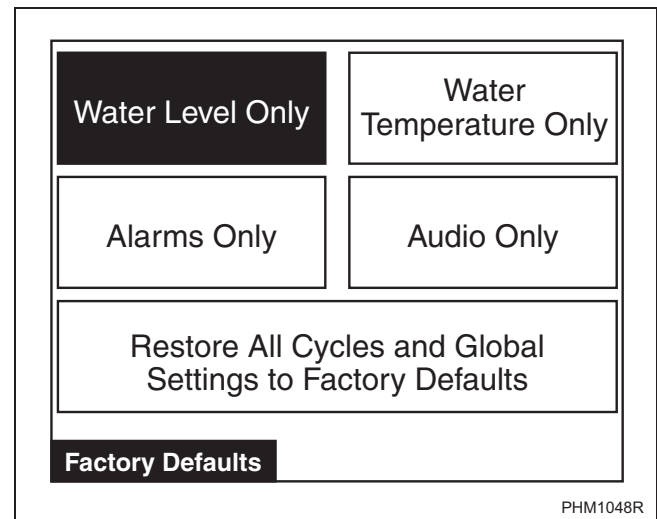









Figure 55

The Factory Defaults Menu is used to set parameters in the software back to the factory default. Several parameters can be set individually back to the factory settings and all Cycles and Global settings can be restored. The individual parameters that can be set back to the factory settings are the water level, water temperature, alarms, and audio settings.

Press the directional keys to navigate through the screen. Press the  keypad to make a selection. Once the  keypad is pressed, Save Changes Screen displays. Use  or  to move highlighted box to “Yes” or “No”. Press the  keypad to return to Global Setup menu. If no changes were made, press the  or  keypad to return to Global Setup Menu.

Water Level Confirmation Menu

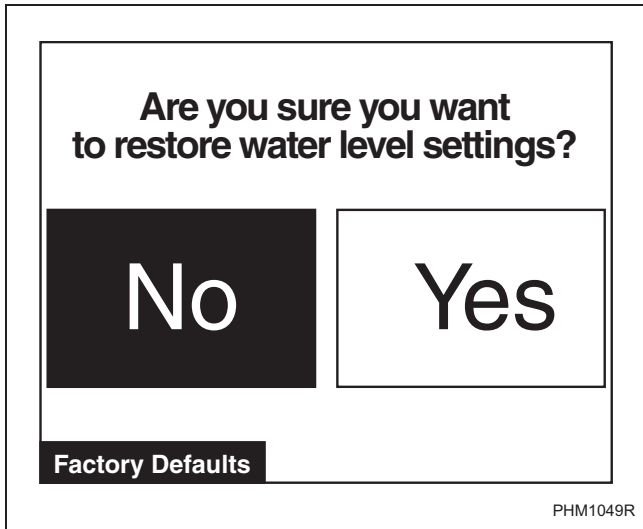

Figure 56

The Water Level Confirmation Menu is used to confirm that water levels are to be set back to factory defaults. This screen is displayed when the Water Level Only option is selected in the Factory Defaults Menu. Once the confirmation is chosen the display will jump back to the Factory Defaults Menu. “No” is selected by default.

Water Temperature Confirmation Menu

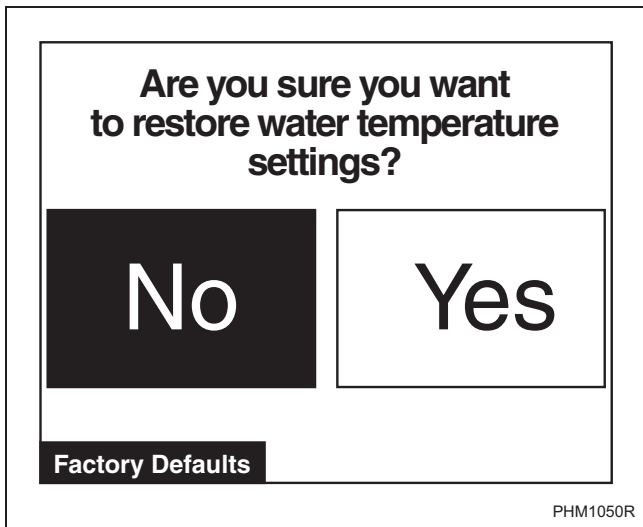





Figure 57

The Water Temperature Confirmation Menu is used to confirm that water temperatures are to be set back to factory defaults. This screen is displayed when the Water Temperature Only option is selected in the Factory Defaults Menu. Once the confirmation is chosen the display will jump back to the Factory Defaults Menu. “No” is selected by default. Use  or  to move highlighted box to “Yes” or “No”. Press the  keypad to return to Global Setup Menu.

Alarms Confirmation Menu

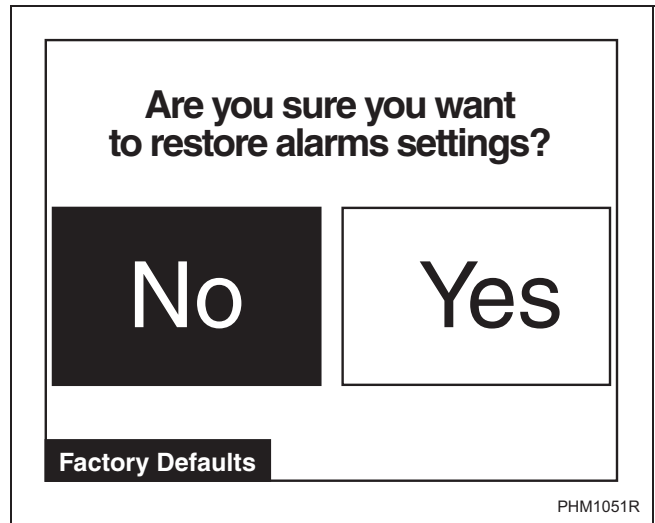

Figure 58

The Alarms Confirmation Menu is used to confirm that the alarms are to be set back to factory defaults. This screen is displayed when the Alarms Only option is selected in the Factory Defaults Menu. Once the confirmation is chosen the display will jump back to the Factory Defaults Menu. “No” is selected by default.

Audio Confirmation Menu

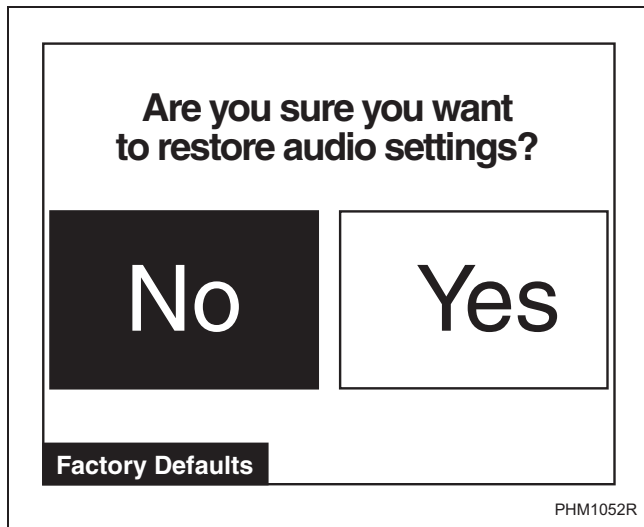

Figure 59

The Audio Confirmation Menu is used to confirm that the audio is to be set back to factory defaults. This screen is displayed when the Audio Only option is selected in the Factory Defaults Menu. Once the confirmation is chosen the display will jump back to the Factory Defaults Menu. “No” is selected by default.

Reset All Factory Defaults Confirmation Menu

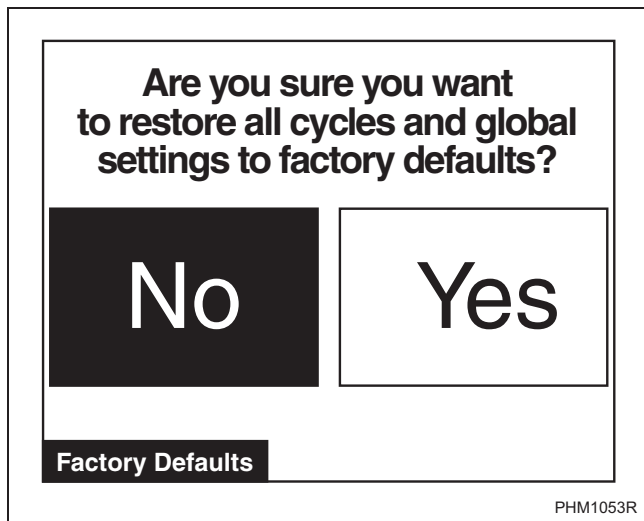

Figure 60

The Reset All Factory Defaults Confirmation Menu is used to confirm that the global programming parameters and Cycle #1-41 are to be set back to factory defaults. This screen is displayed when the Restore All Cycles and Global Settings to Factory Defaults option is selected in the Factory Defaults Menu. If “No” is selected the display will jump back to the Factory Defaults Menu. If “Yes” is selected the display will jump to the Factory Defaults Second Confirmation Menu. “No” is selected by default.

Factory Defaults Second Confirmation Menu



Figure 61

The Factory Defaults Second Confirmation Menu is to ensure that the factory defaults do not get accidentally reset. Press the **BACK** keypad to abort and the display will then show the Factory Defaults Menu. Press the **START ENTER** keypad to select “Yes” or “No”.

Selecting “Yes” will restore all the factory settings and take the user back to the Global Settings Menu. Selecting “No” will take the user back to the Factory Defaults Menu.

Diagnostic

Diagnostic Menu

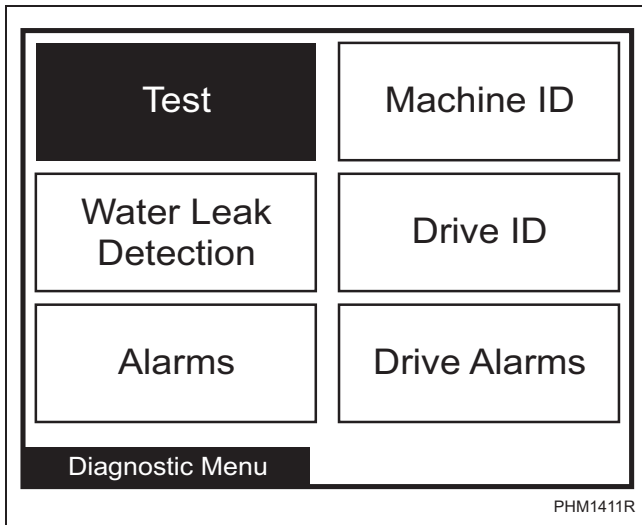

Figure 62

The Diagnostic Menu contains Test, Water Leak Detection, Alarms, Machine ID, Drive ID and Drive Alarms. The menus contain specific diagnostic information and manufacturing data for the machine.

The and keypads position the highlighted box. Press the keypad to select the menu choice.

Press the keypad while in the Diagnostic Menu to return to System Menu.

Drive ID Menu

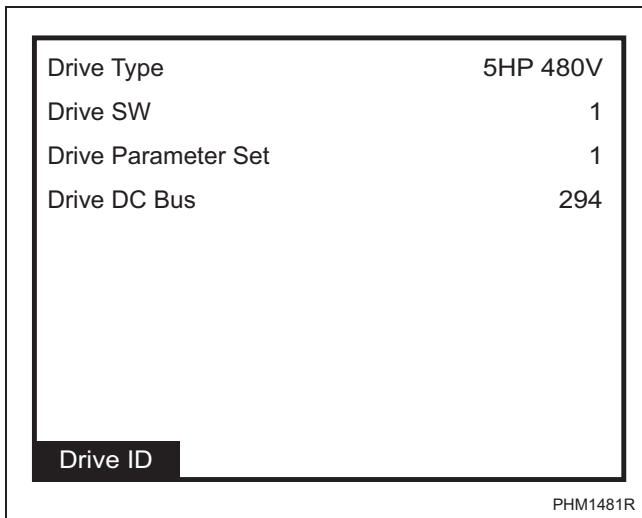

Figure 63

The Drive ID Menu is used to display the drive type, drive software version number, drive parameter set version number, and DC bus value.

Press the keypad to return to the Test Menu.

Drive Alarms Menu

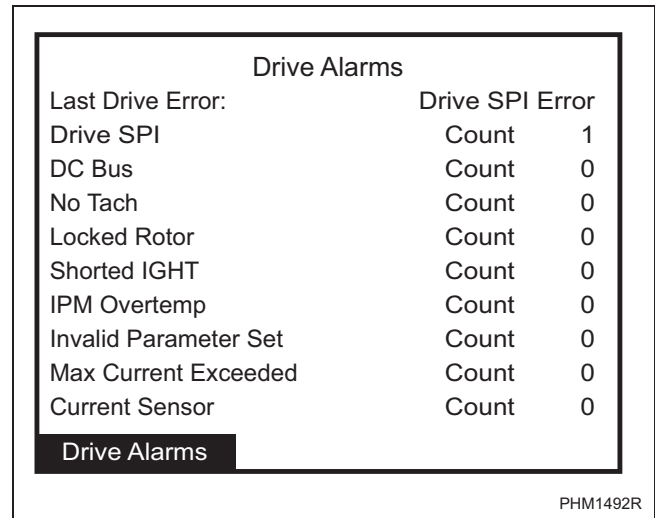

Figure 64

The Drive Alarms Menu is used to display the status of the Last Drive Error and the error counts of the drive errors.

Press the keypad to return to the Test Menu.

Test Menu

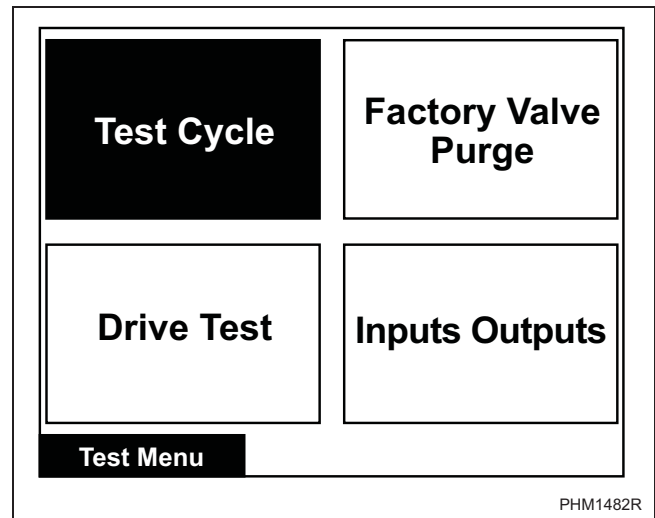

Figure 65

The Test Menu provides features for manufacturing and customer service testing. The highlighted box is moved horizontally and vertically using the and keypads. Press the keypad to select the menu choice.

Press the keypad to return to Diagnostic Menu.

Test Cycle

STEP	Test Cycle Step	Displayed Description	STEP ADVANCE	COMMENTS
1	Keypad Test Step	FEC and Output Board S/W versions and “Press Each Keypad To Advance”	Advance after all keypads depressed.	
2	Door and Lock Test Step	“Door and Lock Status”		
3	Display Test Step	“Press Any Keypad To Advance Through Screen Test”	Keypress	
4	Display Test Step #1	Screen is blank	Keypress	
5	Display Test Step #2	Horizontal Bars	Keypress	
6	Display Test Step #3	Horizontal Bars (inverted)	Keypress	
7	Display Test Step #4	Screen is gray	Keypress	
8	Hot Fill to Low Level	“Hot Fill To Low”	Keypress	All outputs turned off when Low Level reached
9	Cold Fill to Low Level	“Cold Fill To Low”	Keypress	All outputs turned off when Low Level reached
10	Warm Fill to Low Level	“Warm Fill To Low”	Keypress when Low Level is reached	All outputs turned off when Low Level reached
11	Warm Fill to High Level	“Warm Fill to High”	Keypress when High Level is reached	All outputs turned off when High Level reached
12	External Supply #1 Wash Speed Agitate	“External Supply #1”	Keypress	
13	External Supply #2 Wash Speed Agitate	“External Supply #2”	Keypress	
14	External Supply #3 Wash Speed Agitate	“External Supply #3”	Keypress	
15	External Supply #4 Wash Speed Agitate	“External Supply #4”	Keypress	
16	External Supply #5 Wash Speed Agitate	“External Supply #5”	Keypress	
17	External Supply #6 Wash Speed Agitate	“External Supply #6”	Keypress	
18	External Supply #7 Wash Speed Agitate	“External Supply #7”	Keypress	
19	External Supply #8 Wash Speed Agitate	“External Supply #8”	Keypress	
20	Int Supply #1 Wash Speed Agitate	“Internal Supply #1”	Keypress or 30 seconds	
21	Int Supply #2 Wash Speed Agitate	“Internal Supply #2”	Keypress or 30 seconds	

Table 4 (Continued)

Diagnostic

Table 4 (Continued)

STEP	Test Cycle Step	Displayed Description	STEP ADVANCE	COMMENTS
22	Int Supply #3 Wash Speed Agitate	“Internal Supply #3”	Keypress or 30 seconds	
23	Internal Supply #4 Wash Speed Agitate	“Internal Supply #4”	Keypress or 30 seconds	
24	Warm Fill to Overflow Reduced Wash Speed Agitate	“Cold Fill To Overflow”	Keypress	
25*	Heat water to 110F Reduced Wash Speed Agitate	“Heat Water to 110F”	Keypress	All outputs turned off when temperature reached.
26	Reduced Wash Speed Forward with no agitation action.	“Reduced Wash Speed”	Keypress	
27	Wash Speed Forward with no agitation action.	“Wash Speed Forward”	Keypress	
28	Wash Speed Reverse with no agitation action.	“Wash Speed Reverse”	Keypress	
29	Drain Distribution Speed	“Drain”	Keypress when empty	
30	Extract Speed #1 “very low”	“Extract Speed 1”	Keypress	
31	Extract Speed #2 “low”	“Extract Speed 2”	Keypress	
32	Extract Speed #3 “medium”	“Extract Speed 3”	Keypress	
33	Extract Speed #4 “high”	“Extract Speed 4”	Keypress	
34	Extract Speed #5 “very high”	“Extract Speed 5”	Keypress	
35	Extract Speed #6 “ultra high”	“Extract Speed 6”	Keypress	
36	Audio Signal	“Audio Signal”	Keypress or 5 seconds	Step skipped if Global Audio Signal and Global External Signal is disabled.
37	Coast Time	“Coast”		

Table 4

* Step is skipped if no heater in machine.

Factory Valve Purge Menu

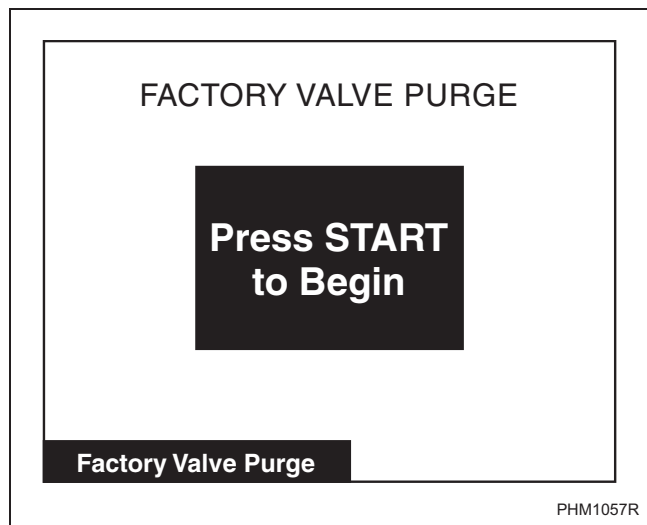

Figure 66

The Factory Valve Purge Menu is used to allow the factory to purge all the valves inside the machine after the machine has been manufactured and tested.

Press the **START** keypad to activate the step. The step will run for five (5) minutes unless the **STOP** keypad is pressed.

Inputs Outputs Menu

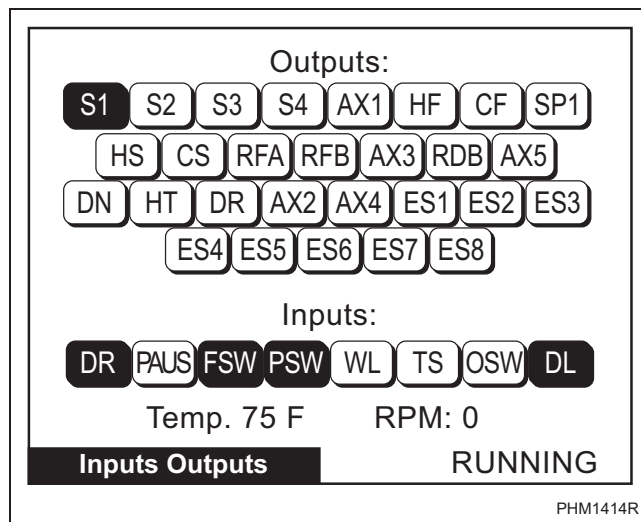

Figure 67

When the Inputs Outputs Menu is accessed through the Diagnostic Menu, the user can change outputs. The Close Door Menu will come up if the door is not closed. The user can scroll through the outputs using any of the arrow keys, the cursor is indicated by flashing the active output on the screen. The user must “setup” the outputs to be turned on. The **STOP** keypad is used to toggle individual outputs to be turned on or off. After the **START** keypad is pressed the control will turn the selected outputs on and display the text “RUNNING”. The outputs cannot be toggled until the **STOP** keypad is pressed. The text “RUNNING” is no longer displayed. The screen will still show the selected outputs on the screen and the user can again toggle outputs to be turned on or off. If the **BACK** keypad is pressed at any time during this test, the control will turn off all outputs if the test is running or return to the previous screen if the test is not running.

Diagnostic

Abbreviations for the Inputs and Outputs are defined in the following table:

Outputs	
AX1	Auxiliary Fill or Internal Supply 5
AX2	Unused
AX3	Recirculation or Reuse Drain A
AX4	External Signal (Optional Audio)
AX5	Reuse Wash Drain
CF	Cold Fill
CS	Cold Spray
DN	Drain
DR	Door Unlock
ES1	External Supply 1
ES2	External Supply 2
ES3	External Supply 3
ES4	External Supply 4
ES5	External Supply 5
ES6	External Supply 6
ES7	External Supply 7
ES8	External Supply 8
HF	Hot Fill
HS	Hot Spray
HT	Heater
RDB	Reuse Drain B
RFA	Reuse Fill A

Outputs	
RFB	Reuse Fill B
S1	Internal Supply 1
S2	Internal Supply 2
S3	Internal Supply 3
S4	Internal Supply 4
SP1	VFD Power

Inputs	
BAL	Unused
DL	Door Lock
DR	Door
FSW	Frame Balance Switch
OSW	Unused
PAUS	External Dispenser Pause A and/or B
PSW	Low Level Pressure Switch
TS	Thermostat (Temp Satisfied)
WL	Water Level (Level Satisfied)
Temp	Temperature Sensor Value
RPM	Revolutions per Minute

Table 5

Water Leak Detection Diagnostic

The Water Leak Detection menu is used to display the result of the Water Leak Detection test.

Press the **START** ENTER keypad to initiate the test.

To end the test before it is complete, press either the **START** ENTER, **STOP** ON/OFF or the **BACK** keypad.

Press the **BACK** keypad to return to the Diagnostic Menu or the Run Diagnostic Menu.

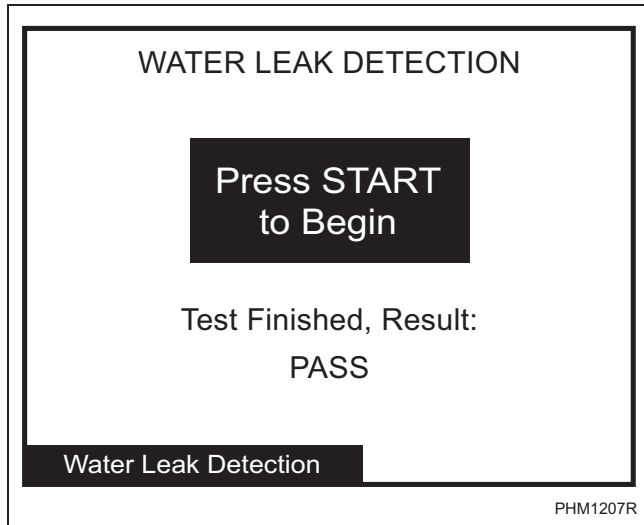

Figure 68

Drive Test

The Drive Test Menu is used to check and display drive and motor functionality. The **▲** LCD and **▼** LCD keypads select the motor speed and direction. Press the **START** ENTER keypad to initiate the test. To end the test before it is complete, press the **STOP** ON/OFF keypad. Press the **BACK** keypad to return the Diagnostic Menu or the Run Diagnostic Menu.

The **START** ENTER keypad to initiate the test. To end the test before it is complete, press the **STOP** ON/OFF keypad. Press the **BACK** keypad to return the Diagnostic Menu or the Run Diagnostic Menu.

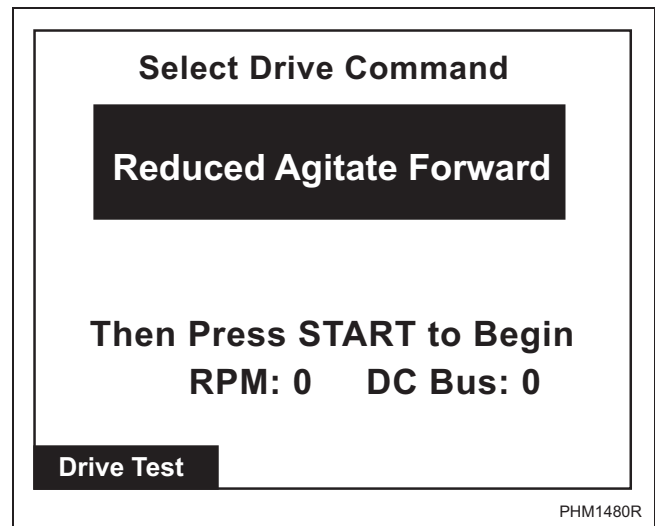

Figure 69

Alarms

ALARM COUNTS	
C01: S02 Unbalance Load Error	11/05 03:34
C01: S04 Fill Error	10/10 13:56
C23: S10 Door Error	08/25 10:41
C02: S15 Unbalance Load Error	04/25 21:30
C11: S04 Unbalance Load Error	01/20 09:25
C39: S11 Drive SPI Error	01/19 02:45

Alarms (1 of 3)

PHM1416R

Figure 70

ALARM COUNTS	
Lock	Count 1
Door	Count 0
Drain	Count 0
Slow Drain	Count 0
Water Leak	Count 0
Fill	Count 1
Frame Balance	Count 1
Open	Count 0

Alarms (2 of 3)

PHM1417R

Figure 71

ALARM COUNTS	
Short	Count 0
SPI	Count 0
Unbalance	Count 3
Heat	Count 0
Level	Count 0
IR	Count 1
Network	Count 1

Alarms (3 of 3)

PHM1418R

Figure 72

The Alarms Menu contains several screens of information. On the first screen, Alarms (1 of 3), the eight most recent alarms will contain Cycle Number, Segment Number, Step, Alarm Type, and the Date/Time of the Alarm.

The second screen, Alarms (2 of 3), alarm counts list 1 through 8. Alarm counts consist of how many times a specific alarm has occurred.

The third screen, Alarms (3 of 3), is a continuation of the alarm counts 9 through 15.

Press the ◀ or ▶ keypad to navigate to the different screens in the Alarms Menu. Press the ◀ keypad to go from screen 1 to screen 3. The actual menus are informational only and cannot be navigated.

Press the BACK keypad to return to display to Diagnostic Menu or the Run Diagnostic Menu.

Machine Identification

Model:	UWN065T4VXU1001
Serial #:	01234567890
Install Date:	10/12/2011
Machine Type:	SL65
Control SN:	6440091
Front End SW:	1
Display SW:	1
Output SW:	3
Trim Value:	2
Node Number:	250
Machine ID	

PHM1490R

Figure 73

The Machine ID Menu provides several different types of manufacturing and machine information that can be useful to the user, chemical supplier, and technician. The Machine ID Menu cannot be navigated. Pressing the **BACK** keypad will return to Diagnostic Menu or the Run Diagnostic Menu.

Machine Errors

The control displays and logs errors as they occur. When the control senses the error condition, the audit counter for that error increases by one. The control saves the time and date of the last eight (8) errors which have occurred. Following is a list of possible errors:

Door Lock Error

If the control is in Door Locking Mode attempting to lock the door and after ten (10) seconds, the control will abort the machine cycle, display the Cycle Aborted Error Menu and record and count the Door Lock Errors audit counter. The control saves the error type, cycle, segment and step in which it happened and the date and the time on the Alarms (1 of 3) Menu. View “Lock” on the Alarms (2 of 3) Menu for the total error count. The audio signal will also be turned on for the error condition. The Cycle Aborted Error Menu is displayed with the Alarm on until the appropriate user input occurs. The machine cycle is aborted and the user is only given the option of clearing the Cycle Aborted Error Menu and returning to the Cycle Menu.

Door Open Error

If the control senses an open loading door during a cycle, the control will abort the machine cycle, display the Cycle Aborted Error Menu and record and count the Door Open Errors audit counter. The control saves the error type, cycle, segment and step in which it happened and the date and the time on the Alarms (1 of 3) Menu. View “Door” on the Alarms (2 of 3) Menu for the total error count. The audio signal will also be turned on for the error condition. The Cycle Aborted Error Menu is displayed with the Alarm on until the appropriate user input occurs. The machine cycle is aborted and the user is only given the option of clearing the Cycle Aborted Error Menu and returning to the Cycle Menu.

Drain Alarm Error

When the Drain Alarm time is exceeded, the control will stop the cycle, display the Cycle Stopped Error Menu and count and store the Total Drain Errors audit counter. The control saves the error type, cycle, segment and step in which it happened and the date and the time on the Alarms (1 of 3) Menu. View “Drain” on the Alarms (2 of 3) Menu for the total error count. The audio signal will also be turned on for the error condition. The Cycle Stopped Error Menu is displayed alternating with the Run Menu (3 seconds Error Menu/3 seconds Run Menu) with the Alarm on until the appropriate user input occurs. The user can continue or abort the machine cycle.

Fill Alarm Error

When the Fill Alarm time is exceeded, the control will stop the cycle and display the Cycle Stopped Error Menu and count and store the Total Fill Errors audit counter. The control saves the error type, cycle, segment and step in which it happened, the date and the time on the Alarms (1 of 3) Menu. View “Fill” on the Alarms (2 of 3) Menu for the total error count. The audio signal will also be turned on for the error condition. The Cycle Stopped Error Menu is displayed alternating with the Run Menu (3 seconds Error Menu/3 seconds Run Menu) with the Alarm on until the appropriate user input occurs. The user is given the option of continuing or stopping the machine cycle.

Diagnostic

Frame Balance Switch Error

If the control detects a Frame Balance Switch error during a cycle, the control will abort the machine cycle, display the Cycle Aborted Error Menu and count and record the Frame Balance Switch Errors audit counter. The control saves the error type, cycle, segment and step in which it happened and the date and the time on the Alarms (1 of 3) Menu. View “Frame Balance” on the Alarms (2 of 3) Menu for the total error count. The audio signal will also be turned on for the error condition. The Cycle Aborted Error Menu is displayed with the Alarm on until the appropriate user input occurs. The machine cycle is aborted and the user is only given the option of powering down the machine to service the Frame Balance Switch error condition.

Open Temperature Sensor Error

If the control senses a temperature less than 5 F in a machine equipped with a temperature sensor, the control will abort the machine cycle, display the Cycle Aborted Error Menu and record and count the Open Thermistor Errors audit counter. The control saves the error type, cycle, segment and step in which it happened and the date and the time on the Alarms (1 of 3) Menu. View “Open” on the Alarms (2 of 3) Menu for the total error count. The audio signal will also be turned on for the error condition. The Cycle Aborted Error Menu is displayed with the Alarm on until the appropriate user input occurs. The machine cycle is aborted and the user is only given the option of clearing the Cycle Aborted Error Menu and returning to the Cycle Menu.

Shorted Temperature Sensor Error

If the control senses a temperature greater than 220 F in a machine equipped with a temperature sensor, the control will abort the machine cycle, display the Cycle Aborted Error Menu and increment the Shorted Thermistor Errors audit counter. The control saves the error type, cycle, segment and step in which it happened and the date and the time on the Alarms (1 of 3) Menu. View “Short” on the Alarms (3 of 3) Menu for the total error count. The audio signal will also be turned on for the error condition. The Cycle Aborted Error Menu is displayed with the Alarm on until the appropriate user input occurs. The machine cycle is aborted and the user is only given the option of clearing the Cycle Aborted Error Menu and returning to the Cycle Menu.

SPI Error

If the control is unable to communicate with the Output Board the control will abort the machine cycle, display the Cycle Aborted Error Menu and increment the SPI Errors audit counter. The control saves the error type, cycle, segment and step in which it happened and the date and the time on the Alarms (1 of 3) Menu. View “SPI” on the Alarms (3 of 3) Menu for the total error count. The audio signal will also be turned on for the error condition. The Cycle Aborted Error Menu is displayed with the Alarm on until the appropriate user input occurs. The machine cycle is aborted and the user is only given the option of clearing the Cycle Aborted Error Menu and returning to the Cycle Menu.

Unbalance Error

If the control detects an unbalanced load during a cycle, the control will run the subsequent Spray Rinse Extract and Extract steps but only at a reduced speed and will continue the machine cycle. When the machine cycle is completed, the control will not display an error but will increment the Unbalance Errors audit counter. The control saves the error type, cycle, segment and step in which it happened and the date and the time on the Alarms (1 of 3) Menu. The machine cycle has already ended and the user is only given the option of unlocking/opening the door and returning to the Cycle Menu. View “Unbalance” on the Alarms (3 of 3) Menu for the total error count.

Heat Alarm Error

When the Heat Alarm time is exceeded, the control will stop the cycle, display the Cycle Stopped Error Menu and count and record the Total Water Heater Errors audit counter. The control saves the error type, cycle, segment and step in which it happened and the date and the time on the Alarms (1 of 3) Menu. The audio signal will also be turned on for the error condition. The Cycle Stopped Error Menu is displayed alternating with the Run Menu (3 seconds Error Menu/ 3 seconds Run Menu) with the Alarm on until the appropriate user input occurs. The user can continue or abort the machine cycle. View “Heat” on the Alarms (3 of 3) Menu for the total error count.

Water Level Sensor Error

If the control senses a High Water Level from the analog Water Level Sensor during an Extract cycle step, the control will abort the machine cycle, display the Cycle Aborted Error Menu, and record and count the Water Level Sensor Errors audit counter. The control saves the error type, cycle, segment and step in which it happened and the date and the time on the Alarms (1 of 3) Menu. View “Level” on the Alarms (3 of 3) Menu for the total error count. The audio signal will also be turned on for the error condition. The Cycle Aborted Error Menu is displayed with the Alarm on until the appropriate user input occurs. The machine cycle is aborted and the user is only given the option of clearing the Cycle Aborted Error Menu and returning to the Cycle Menu.

IR Communications Error

These errors may occur during IR communications. When an error occurs, the display shows the Communication Error Menu. The display on the front-end control will indicate the error by displaying a table with the Error type. The Error Menu is automatically cleared from the display after three (3) seconds. When a PDA error occurs, the audit counter Total Bad IR Communications is increased by one and the hour and date of the event. The error code is saved. This error is not saved on the Alarms (1 of 3) Menu. View “IR” on the Alarms (3 of 3) Menu for the total error count.

Network Communications Error

These errors may occur during network communications. When an error occurs, the audit Counter Total Bad Network is increased by one and the hour, date, and month of the error. The error code is saved. This error is not saved on the Alarms (1 of 3) Menu. View “Network” on the Alarms (3 of 3) Menu for the total error count.

Water Leak Detection Error

If the control detects a water leak or related problem, the control will display a Water Leak Detection Error as described below.

- **Water Leak Detection During a Machine Cycle**
If the Water Leak Detection Error occurs during a machine cycle, the control will record the error and display the message “Water Leak Detected: Drain Valve” or “Water Leak Detected: Fill Valve” at the end of the cycle on the Unlock/Open Door Menu. The control saves the error type as well as the cycle, segment, step, date and time in which the error occurred. The error is added to a queue that holds the last 8 machine errors.

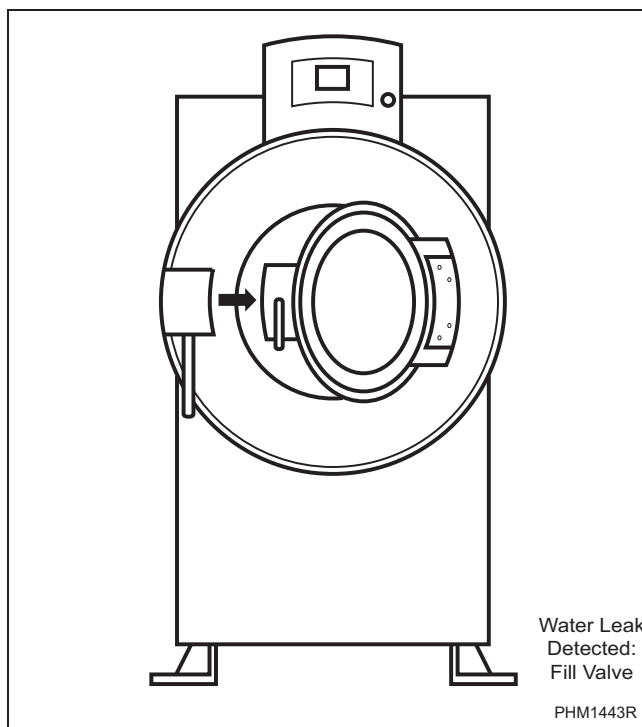

Figure 74

- **Water Leak Detection Error During a Diagnostic Test**

If the Water Leak Detection Error occurs during the Water Leak Detection Diagnostic Test, the control will record the error and display the message “FAIL: Drain Valve” or “FAIL: Fill Valve.” The control saves the error type as well as the date and time on which the error occurred. The error is added to a queue that holds the last 8 machine errors.

- **Water Leak Detection Error During Auto-Water Leak Detection**

If the Water Leak Detection Error occurs during the Auto Water Leak Detection, the control will record the error and display the message “FAIL: Drain Valve” or “FAIL: Fill Valve.” After the test is complete, the control will continue to display the “FAIL: Drain Valve” or “FAIL: Fill Valve.” message until any keypad is pressed, at which point the control will return to the Cycle Menu. The control saves the error type as well as the date and time on which the error occurred. The error is added to a queue that holds the last 8 machine errors.

Diagnostic

Slow Drain Detected During A Machine Cycle Error

If the Slow Drain Error occurs during a machine cycle, the control will record the error and display the message “Slow Drain Detected” on the Door Unlock menu. The control saves the error type as well as the cycle, segment, step, date and time in which the error occurred. The error is added to a queue that holds the last 8 machine errors.

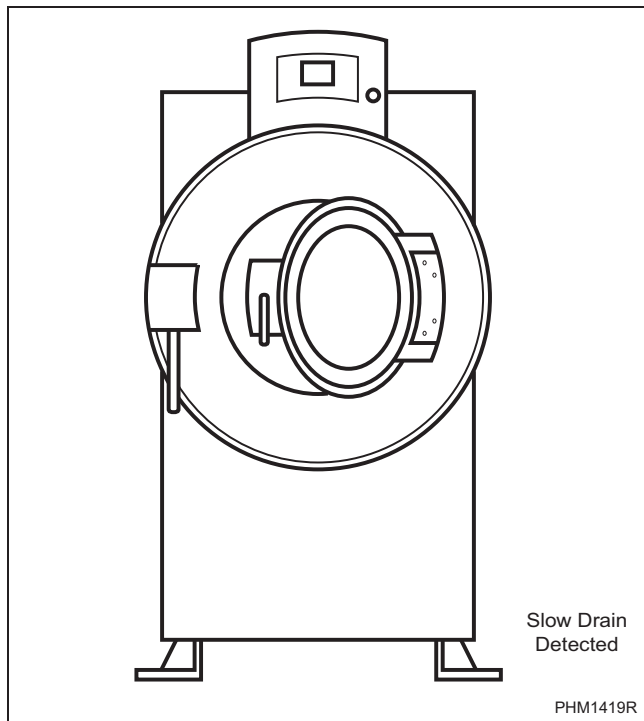

Figure 75

Drive SPI Error

This error may occur when the front end control fails to communicate with the custom drive. If the control detects a Drive SPI error and a cycle was running, the control will abort the cycle, display the Cycle Aborted Error Menu, and record and count the Drive SPI audit counter. If the control detects Drive SPI error in any other mode, the control will display the Error Menu and power must be cycled to clear the error. The control saves the error type, cycle, segment and step in which it happened and the date and time on the Alarms (1 of 3) Menu. The audio signal will also be turned on for the error condition. If the loading door is locked, the control will unlock the door once no water and no coastdown time are detected.

DC Bus Error

If the control detects a DC Bus error during a cycle, the control will abort the cycle, display the Cycle Aborted Error Menu, and record and count the DC Bus audit counter. The control saves the error type, cycle, segment and step in which it happened and the date and time on the Alarms (1 of 3) Menu. The audio signal will also be turned on for the error condition. The Cycle Aborted Error Menu is displayed with the alarm on until the appropriate user input occurs.

No Tachometer Error

If the control detects a No Tachometer error during a cycle, the control will abort the cycle, display the Cycle Aborted Error Menu, and record and count the No Tachometer audit counter. The control saves the error type, cycle, segment and step in which it happened and the date and time on the Alarms (1 of 3) Menu. The audio signal will also be turned on for the error condition. If the loading door is locked, the control will unlock the door once no water and no coastdown time are detected.

Locked Rotor Error

If the control detects a Locked Rotor error during a cycle, the control will abort the cycle, display the Cycle Aborted Error Menu, and record and count the Locked Rotor audit counter. The control saves the error type, cycle, segment and step in which it happened and the date and time on the Alarms (1 of 3) Menu. The audio signal will also be turned on for the error condition. The Cycle Aborted Error Menu is displayed with the alarm on until the appropriate user input occurs.

Shorted IGBT Error

If the control detects a Shorted IGBT error during a cycle, the control will abort the cycle, display the Cycle Aborted Error Menu, and record and count the Shorted IGBT audit counter. The control saves the error type, cycle, segment and step in which it happened and the date and time on the Alarms (1 of 3) Menu. The audio signal will also be turned on for the error condition. The Cycle Aborted Error Menu is displayed with the alarm on until the appropriate user input occurs.

IPM Overtemperature Error

If the control detects an IPM Overtemperature error during a cycle, the control will abort the cycle, display the Cycle Aborted Error Menu, and record and count the IPM Overtemperature audit counter. The control saves the error type, cycle, segment and step in which it happened and the date and time on the Alarms (1 of 3) Menu. The audio signal will also be turned on for the error condition. The Cycle Aborted Error Menu is displayed with the alarm on until the appropriate user input occurs.

Invalid Parameter Set Error

This error may occur when the front end control fails to verify the drive parameter set. If the control detects an Invalid Parameter Set error during a cycle, the control will abort the cycle, display the Cycle Aborted Error Menu, and record and count the Invalid Parameter Set audit counter. The control saves the error type, cycle, segment and step in which it happened and the date and time on the Alarms (1 of 3) Menu. If the control detects an Invalid Parameter Set error in any other mode, the control will display the Error Menu and power must be cycled to clear the error. The audio signal will also be turned on for the error condition. The Cycle Aborted Error Menu is displayed with the alarm on until the appropriate user input occurs.

Maximum Current Exceeded Error

This error may occur when the front end control detects a maximum current exceeded error. If the control detects a Maximum Current Exceeded error during a cycle, the control will abort the cycle, display the Cycle Aborted Error Menu, and record and count the Maximum Current Exceeded audit counter. The control saves the error type, cycle, segment and step in which it happened and the date and time on the Alarms (1 of 3) Menu. The audio signal will also be turned on for the error condition. The Cycle Aborted Error Menu is displayed with the alarm on until the appropriate user input occurs.

Current Sensor Error

If the control detects a Current Sensor error during a cycle, the control will abort the cycle, display the Cycle Aborted Error Menu and record and count the Current Sensor audit counter. The control saves the error type, cycle, segment and step in which it happened and the date and time on the Alarms (1 of 3) Menu. The audio signal will also be turned on for the error condition. The Cycle Aborted Error Menu is displayed with the alarm on until the appropriate user input occurs.

Low DC Bus Error

If the control detects a Low DC Bus error during a cycle, the control will abort motor movement, and record and count the Low DC Bus audit counter. The control saves the error type, cycle, segment and step in which it happened and the date and time on the Alarms (1 of 3) Menu.

Invalid Command Error

If the control detects an Invalid Command error during a cycle, the control will abort motor movement, and record and count the Invalid Command audit counter. The control saves the error type, cycle, segment and step in which it happened and the date and time on the Alarms (1 of 3) Menu.

Last Drive Error

If the control detects a drive error, the control will store the Error Code of the Last Drive error that occurred.

Laundry Management

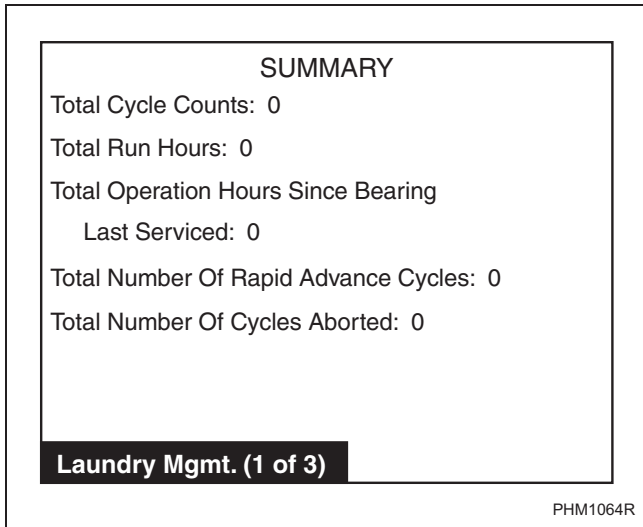

Figure 76

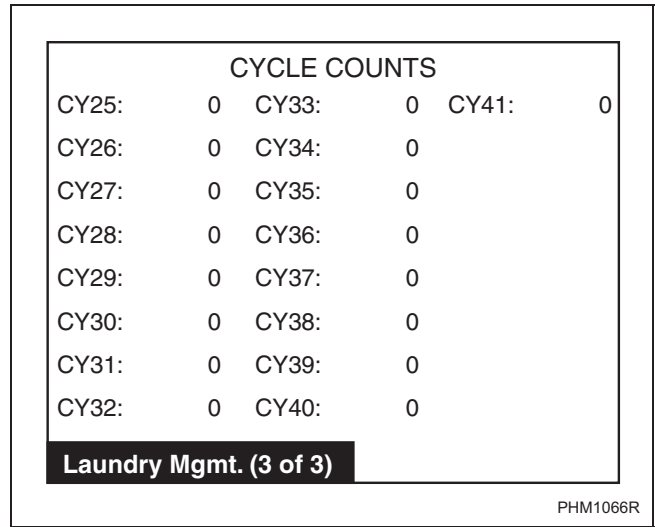

Figure 78

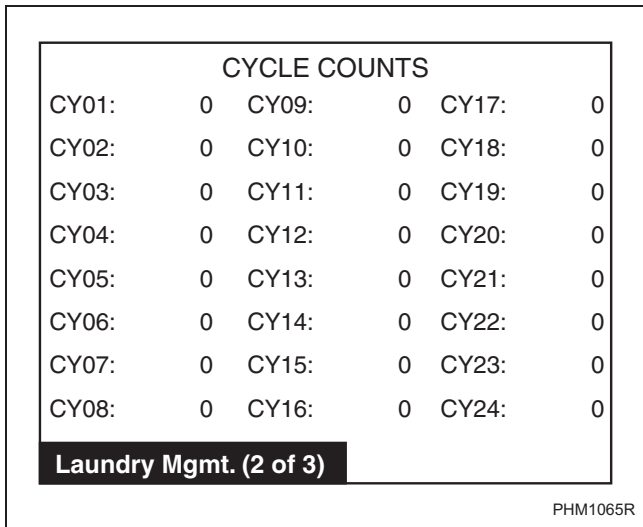

Figure 77

The Laundry Management Menu contains three screens displaying the number of operations per cycle, total cycle counts, and total hours run. The Laundry Management 1 of 3 screens displays Total Cycle Counts, Total Run Hours, Total Operation Hours since Bearing Last Serviced, Total Rapid Advance Cycles and Total Number of Cycles Aborted. The Laundry Management 2 of 3 screen shows user the number of times cycles 1 through 24 have been run. To view cycles 25 through 41, press the keypad to move to Laundry Management 3 of 3 screen. Press the keypad again to move to Laundry Management 1 of 3 screen.

Press the keypad in any of the Laundry Management Menus to enter System Menu.

Total Number of Machine Cycle Counters

Whenever a machine cycle is completed normally without the user Rapid Advancing and not being aborted due to machine errors, the control counts and records the Total Number of Machine Cycles audit counter. If the cycle was Rapid Advanced or was aborted, the control will not increment the Total Number of Machine Cycles audit counter but will increment the Total Number of Rapid Advance Cycles audit counter. If the cycle was aborted due to a machine error, the control will not increment the Total Number of Machine Cycles audit counter but will increment the Total Number of Cycles Aborted audit counter.

Total Number of Operating Minutes Counters

Whenever a machine cycle is operating, the control counts and records the Total Number of Operation Minutes audit counter (not re-settable and displayed in hours) and the Total Number of Operating Minutes Since Bearings Last Serviced auto counter.

Last 10 Machine Cycles Rapid Advanced or Stopped

Whenever a machine cycle is ended, either by the user Rapid Advancing, aborting a cycle or because of a power failure, the control stores the information about that cycle in the next available location, storing the last 10 machine cycles ended in this way. The information stored includes: Cycle number, start month, start date, start hour, start minute, end month, end date, end hour, end minute and how the cycle ended (rapid advance, stop, power failure, or opened door machine error).

Maintenance

Service Schedule Menu

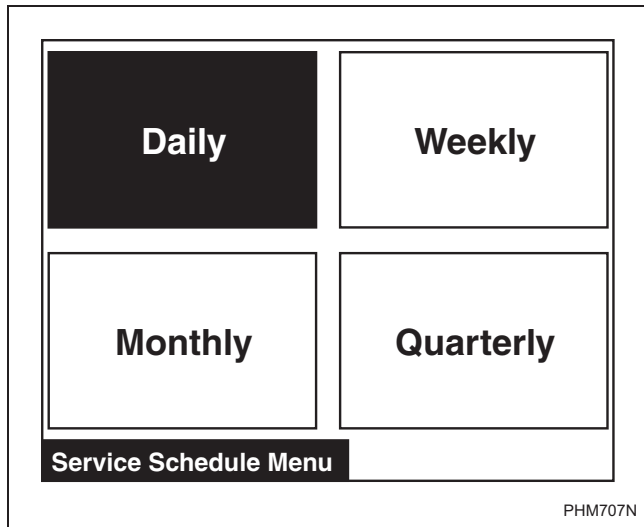

Figure 79

Press **BACK** from Cycle Menu to enter Service Schedule Menu. The Service Schedule Menu provides a user with a time based service reminder list. The list is broken up into “DAILY”, “WEEKLY”, “MONTHLY”, and “QUARTERLY” Menus. Press the **▲ LCD**, **▼**, **◀** or **▶** keypad to navigate to a menu item. Press the **START ENTER** keypad when menu is selected. Press the **BACK** keypad to return to Cycle Menu.

Daily Menu (Service)

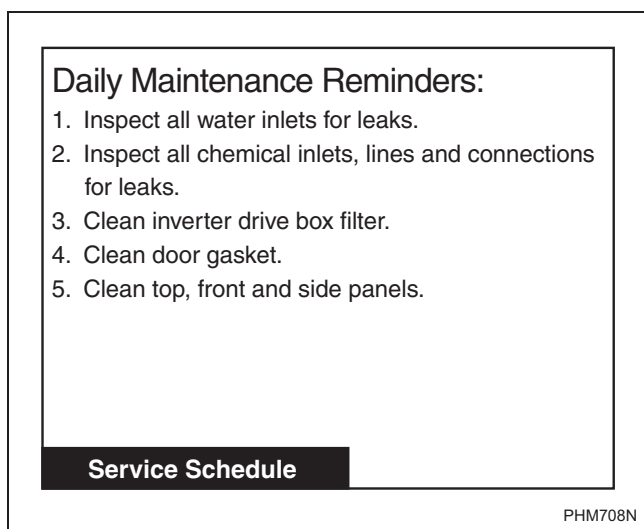

Figure 80

The Daily Menu contains all daily service reminders that need to be performed. Press the **BACK** keypad to return to the Service Menu.

Weekly Menu (Service)

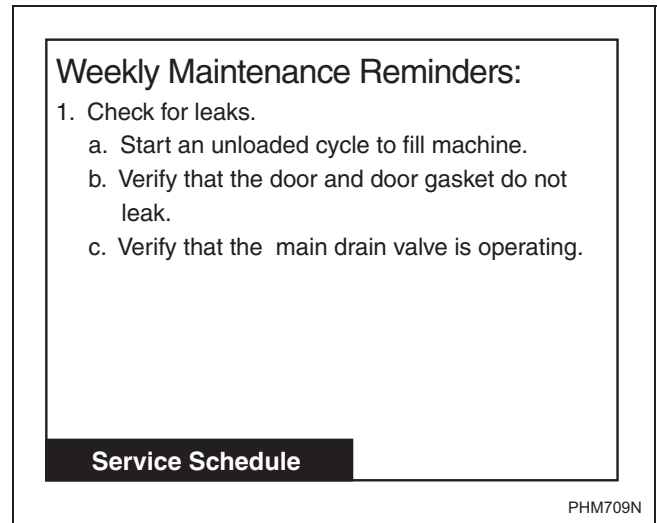

Figure 81

The Weekly Menu contains all weekly service reminders that need to be performed. Press the **BACK** keypad to return to the Service Menu.

Monthly Menu (Service)

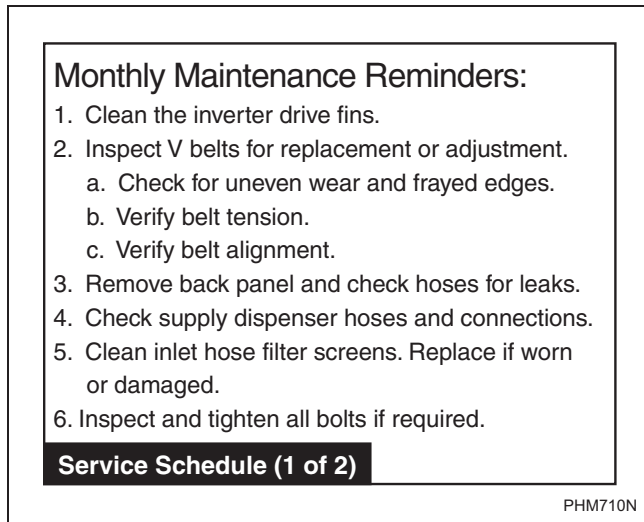

Figure 82

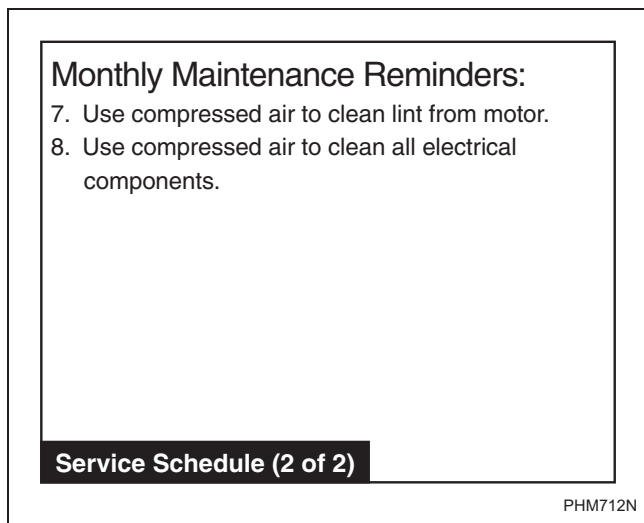



Figure 83

The Monthly Menu contains all monthly service reminders that need to be performed.

Press  or  to view Monthly Menu (2 of 2).

Press the  keypad to return to Service Menu.

Quarterly Menu (Service)

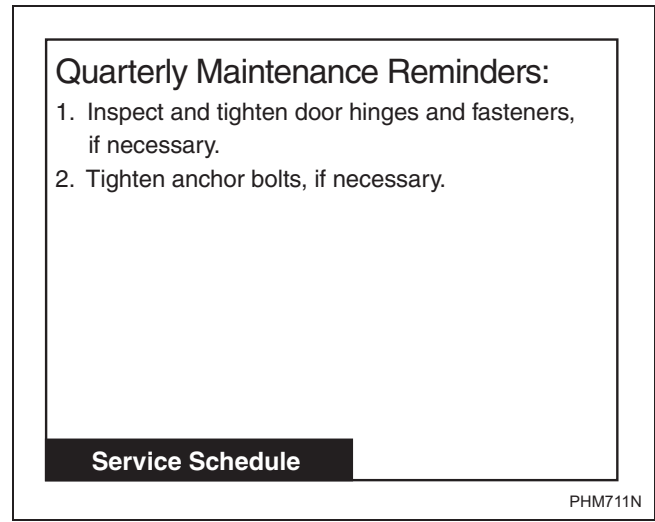



Figure 84

The Quarterly Menu contains all quarterly service reminders that need to be performed. Press the  keypad to return to Service Menu.

Cycle Charts

Cycle No.	Cycle Name	Cycle Display Name	Segment Number & Name	Reuse Fill Step	Fill	Supply A	Supply B	Agitate Step	Cool Down	Drain	Spray Rinse Extract	Extract	EOS	
1	Towels, White, Bleach	Towels White Bleach	#1 Wash		Hot	S1, ES1		18/3/18		Yes				
					Low	45 Sec		8 Min						
			#2 Wash		Hot	S2, ES2		18/3/18		Yes				
					Low	45 Sec		8 Min						
			#3 Rinse		Warm			18/3/18		Yes				
					High			2 Min						
			#4 Rinse		Warm			18/3/18		Yes				
					High			2 Min						
			#5 Rinse		Warm			18/3/18		Yes	Warm			
					High			2 Min			2 Min			
#6 Rinse		Warm	S3, S4 & ES3, ES4		18/3/18		Yes			Ultra High	Yes			
		Low	45 Sec		4 Min					5 Min				
2	Towels, White	Towels White	#1 Wash		Hot	S1, ES1		18/3/18		Yes				
					Low	45 Sec		8 Min						
			#2 Rinse		Warm			18/3/18		Yes				
					High			2 Min						
			#3 Rinse		Warm			18/3/18		Yes				
					High			2 Min						
			#4 Rinse		Warm			18/3/18		Yes	Warm			
					High			2 Min			2 Min			
			#5 Rinse		Warm	S3, S4 & ES3, ES4		18/3/18		Yes			Ultra High	Yes
					Low	45 Sec		4 Min					5 Min	

Table 6 (Continued)

Table 6 (Continued)

Cycle No.	Cycle Name	Cycle Display Name	Segment Number & Name	Reuse Fill Step	Fill	Supply A	Supply B	Agitate Step	Cool Down	Drain	Spray Rinse Extract	Extract	EOS
3	Towels, Colors, Oxygen	Towels Colors Oxygen	#1 Wash		Warm Low	S1, ES1 45 Sec		18/3/18 8 Min		Yes			
			#2 Wash		Hot Low	S2, ES2 45 Sec		18/3/18 8 Min		Yes			
			#3 Rinse		Cold High			18/3/18 2 Min		Yes			
			#4 Rinse		Cold High			18/3/18 2 Min		Yes			
			#5 Rinse		Cold High			18/3/18 2 Min		Yes	Cold 2 Min		
			#6 Rinse		Warm Low	S3, S4 & ES3, ES4 45 Sec		18/3/18 4 Min		Yes		Ultra High 5 Min	Yes
4	Towels, Colors	Towels Colors	#1 Wash		Warm Low	S1, ES1 45 Sec		18/3/18 8 Min		Yes			
			#2 Rinse		Cold High			18/3/18 2 Min		Yes			
			#3 Rinse		Cold High			18/3/18 2 Min		Yes			
			#4 Rinse		Cold High			18/3/18 2 Min		Yes	Cold 2 Min		
			#5 Rinse		Warm Low	S3, S4 & ES3, ES4 45 Sec		18/3/18 4 Min		Yes		Ultra High 5 Min	Yes

Table 6 (Continued)

Cycle Charts

Table 6 (Continued)

Cycle No.	Cycle Name	Cycle Display Name	Segment Number & Name	Reuse Fill Step	Fill	Supply A	Supply B	Agitate Step	Cool Down	Drain	Spray Rinse Extract	Extract	EOS
5	Sheets, White, Bleach	Sheets White Bleach	#1 Wash		Hot Low	S1, ES1 45 Sec		18/3/18 7 Min		Yes			
			#2 Wash		Hot Low	S2, ES2 45 sec		18/3/18 7 Min		Yes			
			#3 Rinse		Warm High			18/3/18 2 Min		Yes			
			#4 Rinse		Warm High			18/3/18 2 Min		Yes	Warm 2 Min		
			#5 Rinse		Warm Low	S3, S4 & ES3, ES4 45 Sec		18/3/18 5 Min		Yes		Ultra High 4 Min	Yes
6	Sheets, White	Sheets White	#1 Wash		Hot Low	S1, ES1 45 Sec		18/3/18 8 Min		Yes			
			#2 Rinse		Warm High			18/3/18 2 Min		Yes			
			#3 Rinse		Warm High			18/3/18 2 Min		Yes	Warm 2 Min		
			#4 Rinse		Warm Low	S3, S4 & ES3, ES4 45 Sec		18/3/18 5 Min		Yes		Ultra High 4 Min	Yes
7	Sheets, Color, Oxygen	Sheets Color Oxygen	#1 Wash		Warm Low	S1, ES1 45 Sec		18/3/18 7 Min		Yes			
			#2 Wash		Warm Low	S2, ES2 45 sec		18/3/18 7 Min		Yes			
			#3 Rinse		Cold High			18/3/18 2 Min		Yes			
			#4 Rinse		Cold High			18/3/18 2 Min		Yes	Cold 2 Min		
			#5 Rinse		Warm Low	S3, S4 & ES3, ES4 45 Sec		18/3/18 4 Min		Yes		Ultra High 4 Min	Yes

Table 6 (Continued)

Table 6 (Continued)

Cycle No.	Cycle Name	Cycle Display Name	Segment Number & Name	Reuse Fill Step	Fill	Supply A	Supply B	Agitate Step	Cool Down	Drain	Spray Rinse Extract	Extract	EOS
8	Sheets, Color	Sheets Color	#1 Wash		Warm Low	S1, ES1 45 Sec		18/3/18 8 Min		Yes			
			#2 Rinse		Cold High			18/3/18 2 Min		Yes			
			#3 Rinse		Cold High			18/3/18 2 Min		Yes	Cold 2 Min		
			#4 Rinse		Warm Low	S3, S4 & ES3, ES4 45 Sec		18/3/18 4 Min		Yes		Ultra High 4 min	Yes
9	Sheets, White, Bleach & Ironer	Sheets White B & I	#1 Wash		Hot Low	S1, ES1 45 Sec		18/3/18 8 Min		Yes			
			#2 Wash		Hot Low	S2, ES2 45 Sec		18/3/18 8 Min		Yes			
			#3 Rinse		Warm High			18/3/18 2 Min		Yes			
			#4 Rinse		Warm High			18/3/18 2 Min		Yes			
			#5 Rinse		Warm High			18/3/18 2 Min		Yes	Warm 2 Min		
			#6 Rinse		Warm Low	S3, S4 & ES3, ES4 45 Sec		18/3/18 4 Min		Yes		Ultra High 5 min	Yes

Table 6 (Continued)

Cycle Charts

Table 6 (Continued)

Cycle No.	Cycle Name	Cycle Display Name	Segment Number & Name	Reuse Fill Step	Fill	Supply A	Supply B	Agitate Step	Cool Down	Drain	Spray Rinse Extract	Extract	EOS
10	Sheets, White, Ironer	Sheets White Ironer	#1 Wash		Hot Low	S1, ES1 45 Sec		18/3/18 8 Min		Yes			
			#2 Rinse		Warm High			18/3/18 2 Min		Yes			
			#3 Rinse		Warm High			18/3/18 2 Min		Yes			
			#4 Rinse		Warm High			18/3/18 2 Min		Yes	Warm 2 Min		
			#5 Rinse		Warm Low		S3, S4 & ES3, ES4 45 Sec		18/3/18 4 Min		Yes		Ultra High 5 min
11	Sheets, Color, Oxygen & Ironer	Sheets Color O & I	#1 Wash		Warm Low	S1, ES1 45 Sec		18/3/18 8 Min		Yes			
			#2 Wash		Warm Low	S2, ES2 45 Sec		18/3/18 8 Min		Yes			
			#3 Rinse		Cold High			18/3/18 2 Min		Yes			
			#4 Rinse		Cold High			18/3/18 2 Min		Yes			
			#5 Rinse		Cold High			18/3/18 2 Min		Yes	Cold 2 Min		
			#6 Rinse		Warm Low		S3, S4 & ES3, ES4 45 Sec		18/3/18 4 Min		Yes		Ultra High 5 min
12	Sheets, Color, Ironer	Sheets Color Ironer	#1 Wash		Warm Low	S1, ES1 45 Sec		18/3/18 8 Min		Yes			
			#2 Rinse		Cold High			18/3/18 2 Min		Yes			
			#3 Rinse		Cold High			18/3/18 2 Min		Yes			
			#4 Rinse		Cold High			18/3/18 2 Min		Yes	Cold 2 Min		
			#5 Rinse		Warm Low		S3, S4 & ES3, ES4 45 Sec		18/3/18 4 Min		Yes		Ultra High 5 min

Table 6 (Continued)

Table 6 (Continued)

Cycle No.	Cycle Name	Cycle Display Name	Segment Number & Name	Reuse Fill Step	Fill	Supply A	Supply B	Agitate Step	Cool Down	Drain	Spray Rinse Extract	Extract	EOS
13	Blankets, Spreads, Warm	Blanket Spreads Warm	#1 Wash		Warm Low	S1, ES1 45 Sec		18/3/18 8 Min		Yes			
			#2 Rinse		Warm High			18/3/18 2 Min		Yes			
			#3 Rinse		Warm High			18/3/18 2 Min		Yes			
			#4 Rinse		Warm High			18/3/18 2 Min		Yes	Warm 2 Min		
			#5 Rinse		Warm Low		S3, S4 & ES3, ES4 45 Sec		18/3/18 4 Min		Yes		Ultra High 5 Min
14	Blankets, Spreads, Cold	Blanket Spreads Cold	#1 Wash		Cold Low	S1, ES1 45 Sec		18/3/18 8 Min		Yes			
			#2 Rinse		Cold High			18/3/18 2 Min		Yes			
			#3 Rinse		Cold High			18/3/18 2 Min		Yes			
			#4 Rinse		Cold High			18/3/18 2 Min		Yes	Cold 2 Min		
			#5 Rinse		Warm High		S3, S4 & ES3, ES4 45 Sec		18/3/18 4 Min		Yes		Ultra High 5 Min

Table 6 (Continued)

Cycle Charts

Table 6 (Continued)

Cycle No.	Cycle Name	Cycle Display Name	Segment Number & Name	Reuse Fill Step	Fill	Supply A	Supply B	Agitate Step	Cool Down	Drain	Spray Rinse Extract	Extract	EOS
15	Sheets, Health Care	Sheets, Health Care	#1 Pre Wash		Warm High			18/3/18 2 Min		Yes			
			#2 Wash		Hot Low	S1, ES1 45 Sec		18/3/18 7 Min		Yes			
			#3 Wash		Hot Low	S2, ES2 45 Sec		18/3/18 7 Min		Yes			
			#4 Rinse		Warm High			18/3/18 2 Min		Yes			
			#5 Rinse		Warm High			18/3/18 2 Min		Yes	Warm 2 Min		
			#6 Rinse		Warm Low	S3, S4 & ES3, ES4 45 Sec		18/3/18 5 Min		Yes		Ultra High 4 Min	Yes
16	Towels, Health Care	Towels Health Care	#1 Pre Wash		Warm High			18/3/18 2 Min		Yes			
			#2 Wash		Hot Low	S1, ES1 45 Sec		18/3/18 8 Min		Yes			
			#3 Wash		Hot Low	S2, ES2 45 Sec		18/3/18 8 Min		Yes			
			#4 Rinse		Warm High			18/3/18 2 Min		Yes			
			#5 Rinse		Warm High			18/3/18 2 Min		Yes			
			#6 Rinse		Warm High			18/3/18 2 Min		Yes	Warm 2 Min		
			#7 Rinse		Warm Low	S3, S4 & ES3, ES4 45 Sec		18/3/18 4 Min		Yes		Ultra High 5 Min	Yes

Table 6 (Continued)

Table 6 (Continued)

Cycle No.	Cycle Name	Cycle Display Name	Segment Number & Name	Reuse Fill Step	Fill	Supply A	Supply B	Agitate Step	Cool Down	Drain	Spray Rinse Extract	Extract	EOS
17	Patient, Health Care	Patient Health Care	#1 Pre Wash		Warm High			18/3/18 2 Min		Yes			
			#2 Wash		Warm Low	S1, ES1 45 Sec		18/3/18 7 Min		Yes			
			#3 Rinse		Warm High			18/3/18 2 Min		Yes			
			#4 Rinse		Warm High			18/3/18 2 Min		Yes	Warm 2 Min		
			#5 Rinse		Warm Low	S3, S4 & ES3, ES4 45 Sec		18/3/18 4 Min		Yes		Medium 4 Min	Yes
18	Diapers, Health Care	Diapers Health Care	#1 Pre Wash		Warm High			18/3/18 2 Min		Yes			
			#2 Pre Wash		Warm High			18/3/18 2 Min		Yes			
			#3 Pre Wash		Warm High			18/3/18 2 Min		Yes			
			#4 Wash		Hot Low	S1, ES1 45 Sec		18/3/18 10 Min		Yes			
			#5 Wash		Hot Low	S2, ES2 45 Sec		18/3/18 10 Min		Yes			
			#6 Rinse		Warm High			18/3/18 2 Min		Yes			
			#7 Rinse		Warm High			18/3/18 2 Min		Yes			
			#8 Rinse		Warm High			18/3/18 2 Min		Yes	Warm 2 Min		
			#9 Rinse		Warm Low	S3, S4 & ES3, ES4 45 Sec		18/3/18 4 Min		Yes		Ultra High 5 Min	Yes

Table 6 (Continued)

Cycle Charts

Table 6 (Continued)

Cycle No.	Cycle Name	Cycle Display Name	Segment Number & Name	Reuse Fill Step	Fill	Supply A	Supply B	Agitate Step	Cool Down	Drain	Spray Rinse Extract	Extract	EOS
19	Blankets/ Spreads Health Care	Blanket Health Care	#1 Pre Wash		Warm High			18/3/18 2 Min		Yes			
			#2 Wash		Warm Low	S1, ES1 45 Min		18/3/18 7 Min		Yes			
			#3 Rinse		Warm High			18/3/18 2 Min		Yes			
			#4 Rinse		Warm High			18/3/18 2 Min		Yes			
			#5 Rinse		Warm High			18/3/18 2 Min		Yes	Warm 2 Min		
			#6 Rinse		Warm Low	S3, S4 & ES3, ES4 45 Sec		18/3/18 4 Min		Yes		Medium 5 Min	Yes
20	Napery White Bleach	Napery White Bleach	#1 Pre Wash		Warm High			18/3/18 2 Min		Yes			
			#2 Wash		Hot Low	S1, ES1 45 Sec		18/3/18 7 Min		Yes			
			#3 Wash		Hot Low	S2, ES2 45 Sec		18/3/18 7 Min		Yes			
			#4 Rinse		Warm High			18/3/18 2 Min		Yes			
			#5 Rinse		Warm High			18/3/18 2 Min		Yes			
			#6 Rinse		Warm High			18/3/18 2 Min		Yes	Warm 2 Min		
			#7 Rinse		Warm Low	S3, S4 & ES3, ES4 45 Sec		18/3/18 4 Min		Yes		Medium 3 Min	Yes

Table 6 (Continued)

Table 6 (Continued)

Cycle No.	Cycle Name	Cycle Display Name	Segment Number & Name	Reuse Fill Step	Fill	Supply A	Supply B	Agitate Step	Cool Down	Drain	Spray Rinse Extract	Extract	EOS
21	Napery White Bleach & Ironer	Napery White B & I	#1 Pre Wash		Warm Low	S1, ES1 45 Sec		18/3/18 7 Min		Yes			
			#2 Wash		Hot Low	S2, ES2 45 Sec		18/3/18 7 Min		Yes			
			#3 Rinse		Warm High			18/3/18 2 Min		Yes			
			#4 Rinse		Warm High			18/3/18 2 Min		Yes			
			#5 Rinse		Warm High			18/3/18 2 Min		Yes	Warm 2 Min		
			#6 Rinse		Warm Low	S5, ES5 45 Sec		18/3/18 4 Min		Yes		Ultra High 5 Min	Yes
22	Napery Color	Napery Color	#1 Pre Wash		Warm High			18/3/18 2 Min		Yes			
			#2 Wash		Hot Low	S1, ES1 45 Sec		18/3/18 10 min		Yes			
			#3 Rinse		Warm High			18/3/18 2 Min		Yes			
			#4 Rinse		Cold High			18/3/18 2 Min		Yes			
			#5 Rinse		Cold High			18/3/18 2 Min		Yes	Cold 2 Min		
			#6 Rinse		Warm Low	S3, S4 & ES3, ES4 45 Sec		18/3/18 4 Min		Yes		Medium 3 Min	Yes

Table 6 (Continued)

Cycle Charts

Table 6 (Continued)

Cycle No.	Cycle Name	Cycle Display Name	Segment Number & Name	Reuse Fill Step	Fill	Supply A	Supply B	Agitate Step	Cool Down	Drain	Spray Rinse Extract	Extract	EOS
23	Napery Color Oxygen	Napery Color Oxygen	#1 Pre Wash		Warm High			18/3/18 2 Min		Yes			
			#2 Wash		Hot Low	S1, ES1 45 Sec		18/3/18 7 Min		Yes			
			#3 Wash		Hot Low	S2, ES2 45 Sec		18/3/18 7 Min		Yes			
			#4 Rinse		Warm High			18/3/18 2 Min		Yes			
			#5 Rinse		Cold High			18/3/18 2 Min		Yes			
			#6 Rinse		Cold High			18/3/18 2 Min		Yes	Cold 2 Min		
			#7 Rinse		Warm Low	S3, S4 & ES3, ES4 45 Sec		18/3/18 4 Min		Yes		Medium 3 Min	Yes
24	Napery Color Ironer	Napery Color Ironer	#1 Pre Wash		Warm High			18/3/18 2 Min		Yes			
			#2 Wash		Hot Low	S1, ES1 45 Sec		18/3/18 10 Min		Yes			
			#3 Rinse		Warm High			18/3/18 2 Min		Yes			
			#4 Rinse		Warm High			18/3/18 2 Min		Yes			
			#5 Rinse		Warm High			18/3/18 2 Min		Yes	Warm 2 Min		
			#6 Rinse		Warm Low	S5, ES5 45 Sec		18/3/18 4 Min		Yes		Ultra High 5 Min	Yes

Table 6 (Continued)

Table 6 (Continued)

Cycle No.	Cycle Name	Cycle Display Name	Segment Number & Name	Reuse Fill Step	Fill	Supply A	Supply B	Agitate Step	Cool Down	Drain	Spray Rinse Extract	Extract	EOS
25	Napery Color Oxygen & Ironer	Napery Color O & I	#1 Pre Wash		Warm Low	S1, ES1 45 Sec		18/3/18 7 Min		Yes			
			#2 Wash		Hot Low	S2, ES2 45 Sec		18/3/18 7 Min		Yes			
			#3 Rinse		Warm High			18/3/18 2 Min		Yes			
			#4 Rinse		Warm High			18/3/18 2 Min		Yes			
			#5 Rinse		Warm High			18/3/18 2 Min		Yes	Warm 2 Min		
			#6 Rinse		Warm Low	S5, ES5 45 Sec		18/3/18 4 Min		Yes		Ultra High 5 Min	Yes
26	Shirts/ Uniforms White Bleach	Shrt/ Unifrm Wht Blch	#1 Wash		Hot Low	S1, ES1 45 Sec		18/3/18 7 Min		Yes			
			#2 Wash		Hot Low	S2, ES2 45 Sec		18/3/18 7 Min		Yes			
			#3 Rinse		Warm High			18/3/18 2 Min		Yes			
			#4 Rinse		Warm High			18/3/18 2 Min		Yes	Warm 2 Min		
			#5 Rinse		Warm Low	S3, S4 & ES3, ES4 45 Sec		18/3/18 4 Min		Yes		Ultra High 5 Min	Yes
27	Shirts White Bleach Starch	Shirts Bleach Starch	#1 Wash		Hot Low	S1, ES1 45 Sec		18/3/18 7 Min		Yes			
			#2 Wash		Hot Low	S2, ES2 45 Sec		18/3/18 7 Min		Yes			
			#3 Rinse		Warm High			18/3/18 2 Min		Yes			
			#4 Rinse		Warm High			18/3/18 2 Min		Yes	Warm 2 Min		
			#5 Rinse		Warm Low	S5, ES5 45 Sec		18/3/18 4 Min		Yes		Ultra High 5 Min	Yes

Table 6 (Continued)

Cycle Charts

Table 6 (Continued)

Cycle No.	Cycle Name	Cycle Display Name	Segment Number & Name	Reuse Fill Step	Fill	Supply A	Supply B	Agitate Step	Cool Down	Drain	Spray Rinse Extract	Extract	EOS
28	Shirts/Uniforms Color	Shirt/Uniform Color	#1 Wash		Warm Low	S1, ES1 45 Sec		18/3/18 10 Min		Yes			
			#2 Rinse		Warm High			18/3/18 2 Min		Yes			
			#3 Rinse		Warm High			18/3/18 2 Min		Yes	Warm 2 Min		
			#4 Rinse		Warm Low	S3, S4 & ES3, ES4 45 Sec		18/3/18 4 Min		Yes		Ultra High 5 Min	Yes
29	Shirts Color Starch	Shirts Color Starch	#1 Wash		Warm Low	S1, ES1 45 Sec		18/3/18 10		Yes			
			#2 Rinse		Warm High			18/3/18 2 Min		Yes			
			#3 Rinse		Warm High			18/3/18 2 Min		Yes	Warm 2 Min		
			#4 Rinse		Warm Low	S5, ES5 45 Sec		18/3/18 4 Min		Yes		Ultra High 5 Min	Yes
30	Starch & Spin Only	Starch Spin Only	#1 Rinse		Warm Low	S3, S5 & ES3, ES5 45 Sec		18/3/18 7 Min		Yes	Ultra High 5 Min	Yes	
31	ECO Towels	ECO Towels	#1 Wash		Hot Low	S1, S2, ES1, ES2 45 Sec		18/3/18 8 Min		Yes	Warm 2 Min 30 Sec		
			#2 Rinse		Warm Low	S3, S4, ES3, ES4 45 Sec		18/3/18 4 Min		Yes		Ultra High 5 Min	Yes

Table 6 (Continued)

Table 6 (Continued)

Cycle No.	Cycle Name	Cycle Display Name	Segment Number & Name	Reuse Fill Step	Fill	Supply A	Supply B	Agitate Step	Cool Down	Drain	Spray Rinse Extract	Extract	EOS
32	ECO Sheets	ECO Sheets	#1 Wash		Hot	S1, S2, ES1, ES2		18/3/18		Yes	Warm	Very Low	
					Low	45 Sec	8 Min		10 Sec	20 Sec			
			#2 Rinse		Warm		18/3/18		Yes	Warm	Very Low		
				High			2 Min		20 Sec	10 Sec			
			#3 Rinse		Warm	S3, S4 & ES3, ES4		18/3/18		Yes		Ultra High	Yes
					Low	45 Sec		4 Min			4 Min		
33	Rags & Mops	Rags & Mops	#1 Pre Wash		Warm			18/3/18		Yes			
					High		2 Min						
			#2 Pre Wash		Warm		18/3/18		Yes				
					High		2 Min						
			#3 Pre Wash		Warm		18/3/18		Yes				
					High		2 Min						
			#4 Pre Wash		Warm		18/3/18		Yes				
					High		2 Min						
			#5 Wash		Hot	S1, ES1	18/3/18		Yes				
		Low	45 Sec	8 Min									
#6 Wash		Hot	S2, ES2	18/3/18		Yes							
		Low	45 Sec	8 Min									
#7 Rinse		Warm		18/3/18		Yes							
		High		2 Min									
#8 Rinse		Warm		18/3/18		Yes							
		High		2 Min									
#9 Rinse		Warm	S3, S4 & ES3, ES4	18/3/18		Yes							
		Low		2 Min				Ultra High	Yes				
								5 Min					

Table 6 (Continued)

Cycle Charts

Table 6 (Continued)

Cycle No.	Cycle Name	Cycle Display Name	Segment Number & Name	Reuse Fill Step	Fill	Supply A	Supply B	Agitate Step	Cool Down	Drain	Spray Rinse Extract	Extract	EOS	
34	Stain Reclaim	Stain Reclaim	#1 Wash		Hot Low	S1, S2 & ES1, ES2 45 Sec		18/3/18 30 Min		Yes				
			#2 Rinse		Warm High			18/3/18 2 Min		Yes				
			#3 Rinse		Warm High				18/3/18 2 Min		Yes			
			#4 Rinse		Warm High				18/3/18 2 Min		Yes	Warm 2 Min		
			#5 Rinse		Warm High				18/3/18 5 Min		Yes		Ultra High 5 Min	Yes
35	Heavy Soil Bleach	Heavy Soil Bleach	#1 Pre Wash		Warm High			18/3/18 2 Min		Yes				
			#2 Pre Wash		Warm High			18/3/18 2 Min		Yes				
			#3 Wash		Hot Low	S1, ES1 45 Sec		18/3/18 8 Min		Yes				
			#4 Wash		Hot Low	S1, ES1 45 Sec		18/3/18 8 Min		Yes				
			#5 Wash		Hot Low	S2, ES2 45 Sec		18/3/18 8 Min		Yes				
			#6 Rinse		Warm High			18/3/18 2 Min		Yes				
			#7 Rinse		Warm High			18/3/18 2 Min		Yes				
			#8 Rinse		Warm High			18/3/18 2 Min		Yes	Warm 2 Min			
			#9 Rinse		Warm Low	S3, S4 & ES3, ES4 45 Sec		18/3/18 4 Min		Yes		Ultra High 5 Min	Yes	

Table 6 (Continued)

Table 6 (Continued)

Cycle No.	Cycle Name	Cycle Display Name	Segment Number & Name	Reuse Fill Step	Fill	Supply A	Supply B	Agitate Step	Cool Down	Drain	Spray Rinse Extract	Extract	EOS
36	Overnight Soak	Over Night Soak	#1 Pre Wash		Hot High			18/3/18 2 Min		Yes			
			#2 Wash		Hot High	S1, ES1 45 Sec		No Rotate 8 Hours		Yes			
			#3 Rinse		Warm High			18/3/18 2 Min		Yes			
			#4 Rinse		Warm High			18/3/18 2 Min		Yes			
			#5 Rinse		Warm High	S3, S4 & ES3, ES4 45 Sec		18/3/18 4 Min		Yes		Ultra High 5 Min	Yes
37	Rinse & Spin	Rinse Spin Only	#1 Rinse		Warm Low			18/3/18 2 Min		Yes	Ultra High 4 Min	Yes	
38	Delicate	Delicate	#1 Wash		Cold Med	S1, ES1 45 Sec		3/27/3 6 Min		Yes			
			#2 Rinse		Cold High			3/27/3 2 Min		Yes			
			#3 Rinse		Cold High			3/27/3 2 Min		Yes			
			#4 Rinse		Warm Low	S3, S4 & ES3, ES4 45 Sec		3/27/3 5 Min		Yes		Very Low 2 Min	Yes
39	General Short	General Short	#1 Wash		Hot Low	S1, ES1		18/3/18 12 Min		Yes			
			#2 Rinse		Warm High			18/3/18 3 Min		Yes		Medium 1 Min	
			#3 Rinse		Warm High			18/3/18 3 Min		Yes	Warm 2 Min	Ultra High 5 Min	Yes

Table 6 (Continued)

Cycle Charts

Table 6 (Continued)

Cycle No.	Cycle Name	Cycle Display Name	Segment Number & Name	Reuse Fill Step	Fill	Supply A	Supply B	Agitate Step	Cool Down	Drain	Spray Rinse Extract	Extract	EOS
40	General Long	General Long	#1 Pre Wash		Warm High			18/3/18 2 Min		Yes			
			#2 Wash		Hot Low	S1, ES1 45 Sec		18/3/18 15 Min		Yes			
			#3 Rinse		Warm High			18/3/18 3 Min		Yes		Medium 1 Min	
			#4 Rinse		Warm High			18/3/18 3 Min		Yes	Warm 2 Min	Ultra High 5 Min	Yes
41	Supply Set Up	Supply Set Up	#1 Rinse		Warm Low	S1, S2 & ES1, ES2 45 Sec	S3, S4, S5 & ES3, ES4, ES5 45 Sec	18/3/18 2 Min		Yes			
			#2 Rinse		Warm Low			18/3/18 1 Min		Yes			Yes

Table 6