

# LEGEND

- COMPONENT MAY OR MAY NOT BE USED
- TIMER CONSTRUCTION
- TERMINAL CONNECTION
- SPLICE
- 8 IN LINE CONNECTION

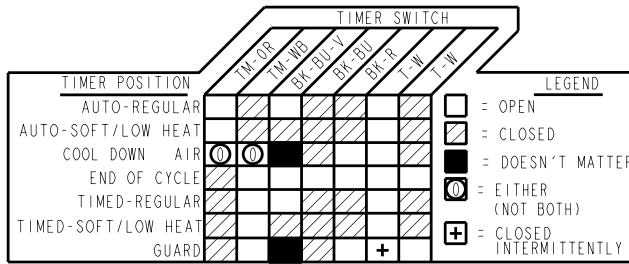

MANUFACTURED UNDER ONE OR MORE OF THE FOLLOWING U.S. PATENTS:

3,702,030	3,890,720	4,132,008
3,762,064	3,959,891	4,385,452
3,769,716	3,962,617	4,430,809
3,815,258	4,003,613	4,821,535
3,889,392	4,086,709	

CAUTION: LABEL ALL WIRES PRIOR TO DISCONNECTION WHEN SERVICING CONTROLS. WIRING ERRORS CAN CAUSE IMPROPER AND DANGEROUS OPERATION. VERIFY PROPER OPERATION AFTER SERVICING.

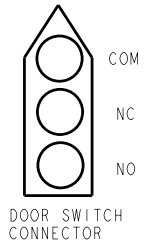
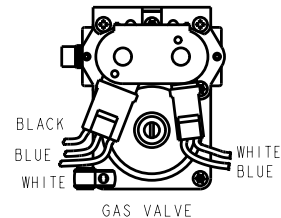
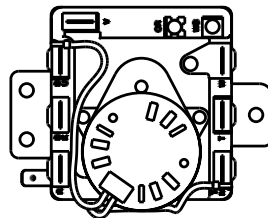
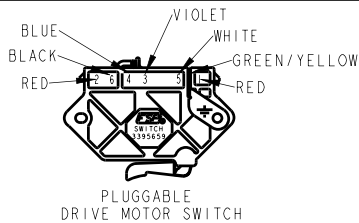
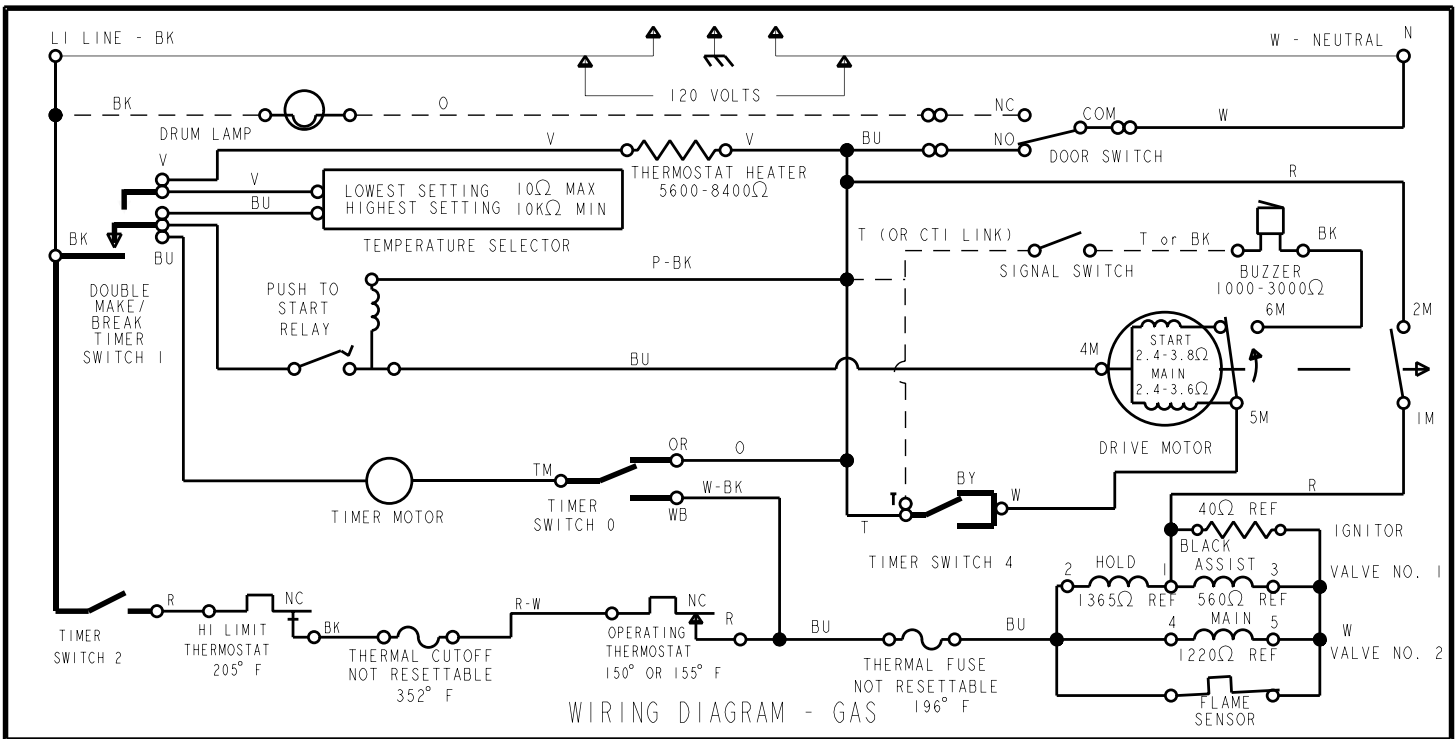
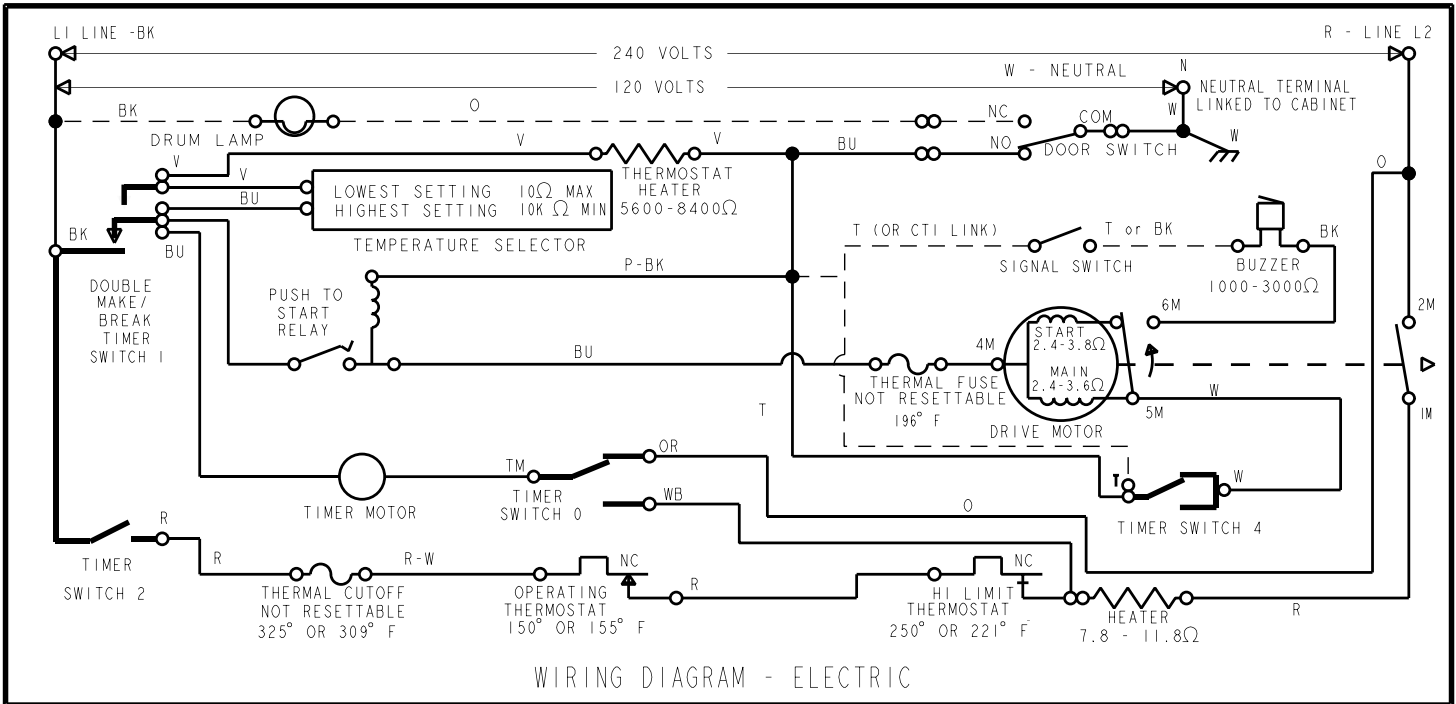

PART NO.  
**W1014115**  
REV A