

180 SECONDS PER STEP

MACHINE FUNCTION
FONCTIONS DE LA MACHINE
FUNCION de la MAQUINA

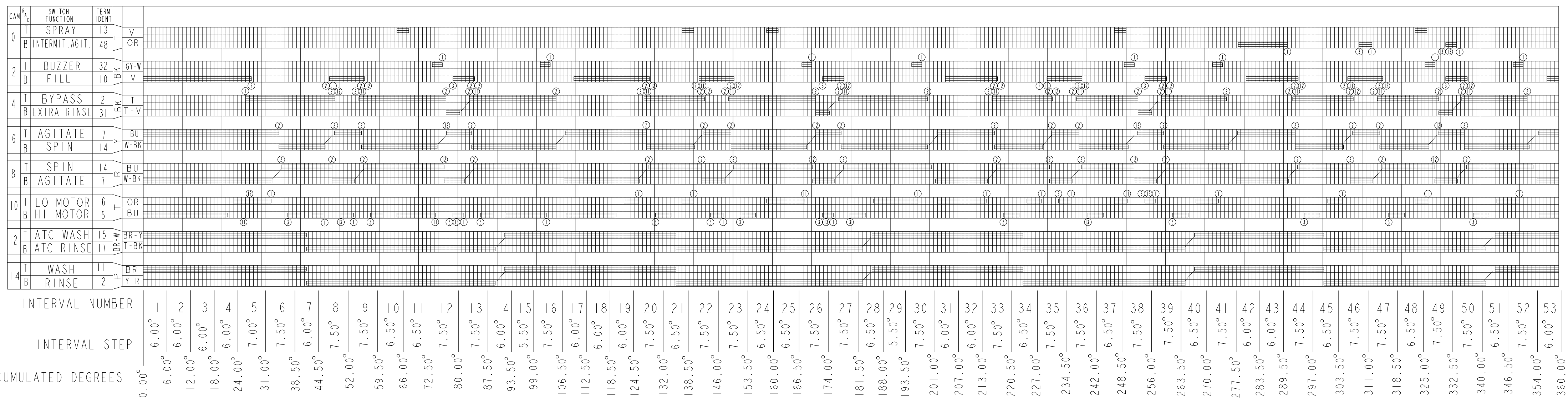



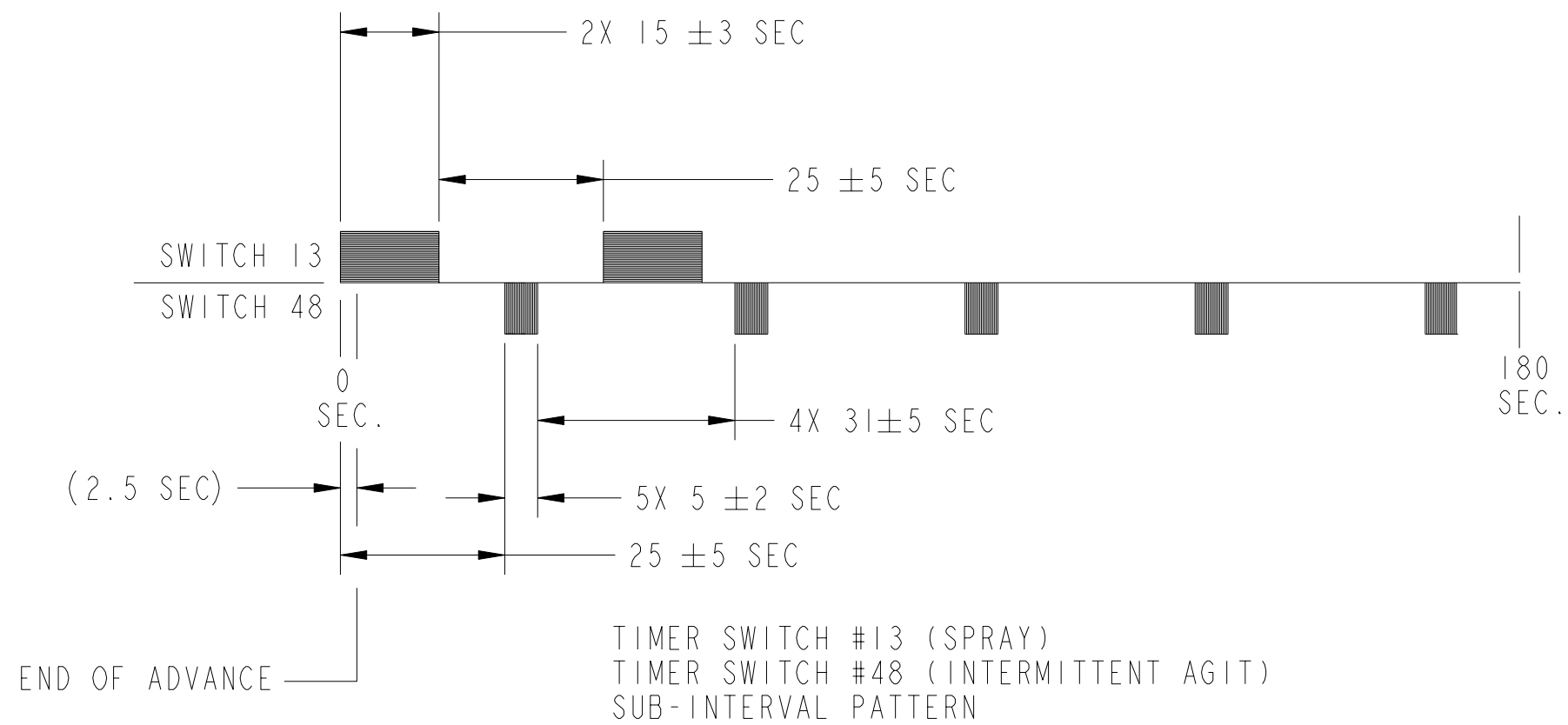

SUPER WASH		HEAVY EMPORTE / RESISTENTE					EXTRA RINSE		PERMANENT PRESS SYNTHETIQUES / PERMANENTE PRENSA					EXTRA RINSE		DELICATE DELICAT / DELICADO			EXTRA RINSE		HAND WASHABLES OUVIER LAVER / ENTREGUE WASHABLES				EXTRA RINSE																											
FILL-AGITATE HI		FILL-AGITATE HI	DRY AGITATE - LO	DRAIN HI	SPIN HI	FILL & AGITATE HI	DRAIN HI	SPIN HI	SPRAY	SPIN HI	OFF - AUTO	AGITATE HI	DRAIN HI	SPIN HI	OFF	FILL-AGITATE HI	FILL-AGITATE LO	DRAIN HI	SPRAY	SPIN LO	FILL - AGITATE HI	DRAIN HI	SPIN LO	OFF - AUTO	AGITATE HI	DRAIN HI	SPIN LO	OFF	FILL-AGITATE LO	DRAIN HI	SPIN LO	FILL - AGITATE LO	DRAIN HI	SPRAY	SPIN LO	OFF - AUTO	AGITATE LO	DRAIN HI	SPIN LO	OFF	INTERMITTENT AGITATION 5 SEC ON 30 SEC OFF LO	DRAIN HI	SPIN LO	INTERMITTENT AGIT LO	DRAIN HI	SPRAY	SPIN LO	OFF - AUTO	FILL - INT AGIT LO	DRAIN HI	SPIN LO	OFF

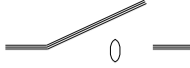

LEGEND	LEGENDE	LEYENDA
OFF	ARRET	DE
SPRAY	GICLAGE	AEROSOL
BYPASS	DERIVATION	PUENTE
FILL	REMPLISSAGE	LLENAN
AGITATE	AGITER	AGITAN
SPIN	ESSORAGE	VUELTA
HI MOTOR	MOTEUR RAPIDE	ALTO MOTOR
LOW MOTOR	MOTEUR BAS	BAJO MOTOR
WARM/COLD	CHAUDE/FROIDE	CALIENTESE/FRIO
WASH	LAVAGE	COLADA
RINSE	RINCAGE	ACLARACION
DRAIN	VIDENT	DRENAN
DRY/AGITATE	SECHER/AGITER	SECO/AGITAN
BUZZER	VIBREUR	ZUMBADOR
INTERMIT .AGIT	AGITER INTERMITTENT	INTERMITENTE AGITA
EXTRA RINSE	RINCAGE DE PLUS	ACLARADO EXTRA
SUPER WASH	LAVAGE FORMIDABLE	SUPER LAVADO

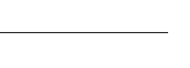

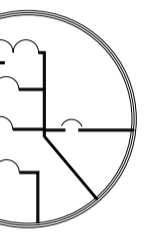

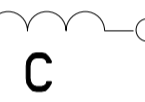
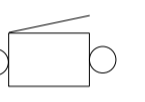
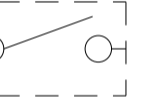
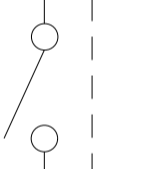



LEGEND / LEGENDE / LEYENDA

-  TIMER SWITCH
INT. DU PROGRAMMATEUR
INTERRUPTOR DEL TEMPORIZADOR
-  INT. COMP CONNECTION
CONNEXION INTERNE DE COMPOSANT
CONEXION INTERNO DEL COMPONENTE
-  HARNESS WIRING
FAISCEAU DE FILS
CABLEADO DEL HARNESS
-  HARNESS CONNECTION
CONNEXION DE FILS
CONEXION DEL HARNESS
-  TERMINAL CONNECTION
CONEXION DE LA BORNE
TERMINAL CONEXION
-  DRIVE MOTOR / MOTEUR / IMPULSOR MOTOR
L LOW / LENT / BAJO
M MED / MED / MEDIA
H HIGH / HAUT / ALTO
S START / DEMARRENT / EMPIEZAN
-  HOT VALVE
SQUAPE D'EAU CHAUDE
CALIENTE VALVULA
-  COLD VALVE
SQUAPE D'EAU FROIDE
FRIA VALVULA
-  BUZZER
VIBREUR
ZUMBADOR
-  BUZZER ON/OFF
VIBREUR SUR/ARRET
ZUMBADOR EN LEJOS
-  EXTRA RINSE SW SHOWN OFF
RINCADE DE PLUS
ACLARADO EXTRA

ATC BOARD
CARTE DE CIRCUITS ATC
TARJETA DEL ATC

FABRIQUE SOUS UN OU PLUSIEURS
DES BREVETS CANADIENS SUIVANTS:
1228410, 1233039, 1233658, 1282557,
1287338, 1288966, 1298988, 1301469,
1306367, 1313770, 2018975, 2022266,
2043393, 2056969, 2086151, D76618

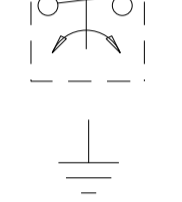
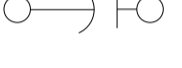
MANUFACTURADO BAJO UNA O MAS DE
LAS SIGUIENTES PATENTES MEXICANAS:
159840, 159983, 161744, 163722, 164305,
164407, 165938, 165992, 170221, 174138,
174478, 174483, 177764, 177766, 181185,
182183, 182396, 182632, 187728, 189682,
189766, 192502, 192503, 198393, 199844,
205519, 211042

-  WATER LEVEL SWITCH
INTERRUPTEUR NIVEAU D'EAU
INTERRUPTOR DEL NIVEL DEL AGUA
-  FULL / PLEIN / POR COMPLETO
-  EMPTY / VIDE / VACIO
-  LID SWITCH
INTERRUPTEUR DU COUVERCLE
INTERRUPTOR DE LA TAPA
-  TIMER MOTOR
MOTEUR DE LA MINUTERIE
MOTOR DEL TEMPORIZADOR
-  CENTRIFUGAL SWITCH
CONTACTEUR CENTRIFUGE
CENTRIFUGO INTERRUPTOR
-  CABINET GROUND
TERRE DU CHASSI
CABIN MOLIDA
-  CAPACITOR /
CONDENSATEUR /
CONDENSADOR
- TSC** TEMPERATURE SWITCH CHART
DIAGRAMME DE COMMUTATEUR
DE LA TEMPERATURE
CARTA DE INTERRUPTOR
DE LA TEMPERATURA

NOT USED ON ALL MODELS

TSC			
POS	WASH RINSE	WASH TEMP	RINSE TEMP
1	C/C	COLD	COLD
2	H/C	100°	COLD
3	W/C	73°	COLD

MANUFACTURED UNDER ONE OR MORE
OF THE FOLLOWING US PATENTS:
4545947, 4555919, 4566295, 4572596, 4618193,
4624117, 4643350, 4646545, 4656844, 4656847,
4692987, 4693095, 4697293, 4700554, 4709951,
4715401, 4719769, 4754622, 4759202, 4774822,
4779431, 4782544, 4784666, 4785643, 4793820,
4807452, 4809524, 4835991, 4854559, 4856303,
4870988, 4888965, 4890465, 4891959, 4910979,
4945735, 4947516, 4969341, 4972134, 4977394,
4986093, 4987627, 5000016, 5031427, 5033277,
5074003, 5075613, 5113542, 5130624, 5150588,
5154071, 5166568, 5167722, 5172573, 5177659,
5191667, 5191668, 5191669, 5193361, 5199127,
5199281, 5200684, 5205141, 5219370, 5233718,
5249441, 5255844, 5257901, 5259217, 5269160,
5271251, 5297403, 5305485, 5312138, 5314044,
5345637, 5345792, 5345793, 5359744, 5373715,
5460018, 5493745, 5504955, 5507053, 5515565,
5582039, 5582199, 5651278, 5671494, 5765404,
5784902, 5791167, 5836180, 5852942, 5875655,
5878602, 5883490, 5946946, 6065171, 6070282,
6105403, 6115863, 6125490, 6185774, 6212722,
6227013, 6227014, 6269666, 6347645, 6363563,
6393872, 6430971, 6505370, D314263, D375390,
D381140, D423740, D426686, D456572,
D459844, D463631, D465308

TIMER KNOB PUSH OFF ALL TIMER SWITCHES OPEN
BOUTON DE LA MINUTERIE ENFONCE (ARRET)-TOUS LES
AUTRES COMMUTATEURS DE LA MINUTERIE OUVERTS
PERILLA DEL TEMPORIZADOR OPRIMIDA (APAGADO)-TODOS
LOS INTERRUPTORES DEL TEMPORIZADOR ABIERTOS

PART No.
PIECE N°
PIEZA N°

8566203

REV.
REV.
REV.

A

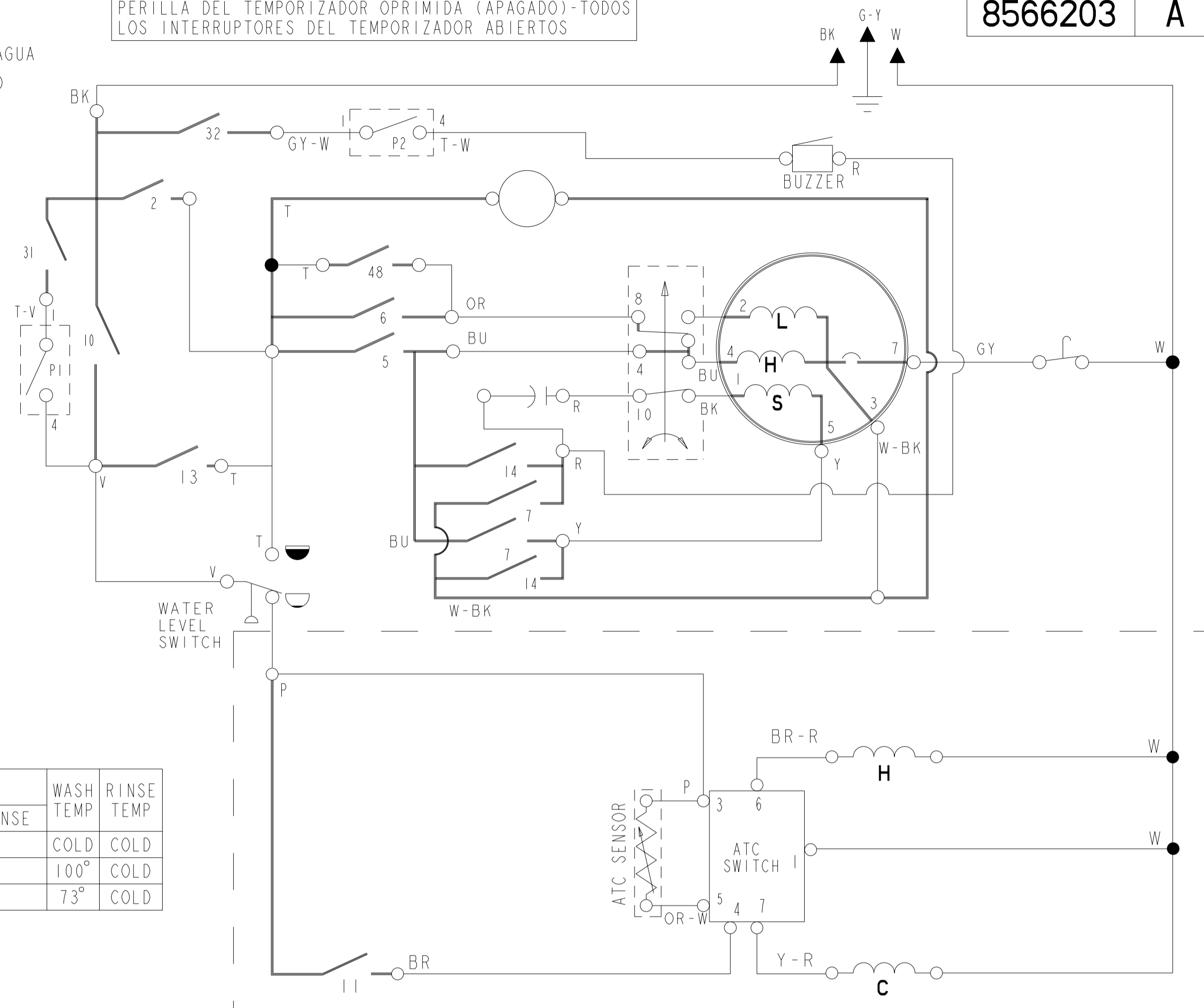

TSC		# NOT USED ATC 4	
POS	WASH / RINSE	WASH TEMP	RINSE TEMP
1	H/C	HOT	COLD
2	C/C	COLD	COLD
3	W/W	93°	70°
#4	W/C	93°	COLD
5	C/C	70°	COLD