

| | | | | | | | | | | | | | | | | | | | | | | | |
|----------------|--------------------|-----------------|----------------|-------|------------------|----------------|-----------------|----------------|-------------------|-------|----------------|-------|-----|----------------|-------------|----------------|-------------|----------------|------|----------------|----------|------|-----|
| FILL - AGITATE | FILL - AGITATE MED | DRY AGITATE MED | FILL - AGITATE | SPRAY | OFF - TIMED FILL | FILL - AGITATE | OFF | FILL - AGITATE | FILL - AGITATE LO | SPRAY | FILL - AGITATE | SPRAY | OFF | FILL - AGITATE | SOAK | FILL - AGITATE | SOAK | FILL - AGITATE | SOAK | FILL - AGITATE | DRAIN HI | SPIN | OFF |
| FILL & WASH | | | | | | | | | | | | | | | FILL & SOAK | | FILL & SOAK | | | | DRAIN HI | SPIN | OFF |
| NORMAL | | | | | EXTRA RINSE | | PERMANENT PRESS | | | | | SOAK | | | | PREWASH | | | | | | | |

| ENGLISH | FRENCH | SPANISH |
|-----------------|---------------------|----------------------|
| AGITATE | AGITER | AGITAN |
| BLEACH | BLANCHIMENT | BLANQUEO |
| BUZZER | VIBEUR | SEÑAL SONORA |
| BYPASS | DERIVATION | PUESTO |
| DRAIN | VIDENT | DRENAN |
| EXTRA RINSE | RINCAGE DE PLUS | ADICIONAL ACLARACION |
| FILL | REMPLISSAGE | LLENAN |
| HIGH | HAUT | ALTO |
| INT AGITATE | AGITER INTERMITTENT | INTERMITENTE AGITE |
| LO | LENT | BAJO |
| MED | MED | MEDIA |
| MOTOR | MOTEUR | MOTOR |
| NORMAL | NORMALE | NORMAL |
| PERMANENT PRESS | SYNTHETIQUES | PERMANTENT PRENSA |
| PREWASH | PRE LAVAGE | PRE COLADA |

| ENGLISH | FRENCH | SPANISH |
|------------|--------------------------|------------------------|
| RINSE | RINCAGE | ACLARACION |
| SOAK | IMBIBERT | REMOJAN |
| SPIN | ESSORAGE | VUELTA |
| SPRAY | CICLAGE | AEROSOL |
| WASH | LAVAGE | COLADA |
| TIMED FILL | SYNCHRONISES REMPLISSAGE | SINCRONIZADO TERRAPLEN |

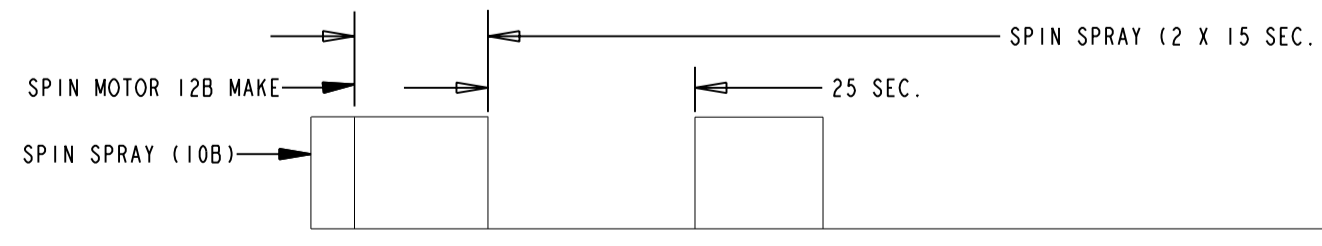

NOTE:
 ## NOT AVAILABLE ALL MODELS.
 KEY
 ☐ CONTACT OPEN ON CHART
 ■ CONTACT CLOSED ON CHART

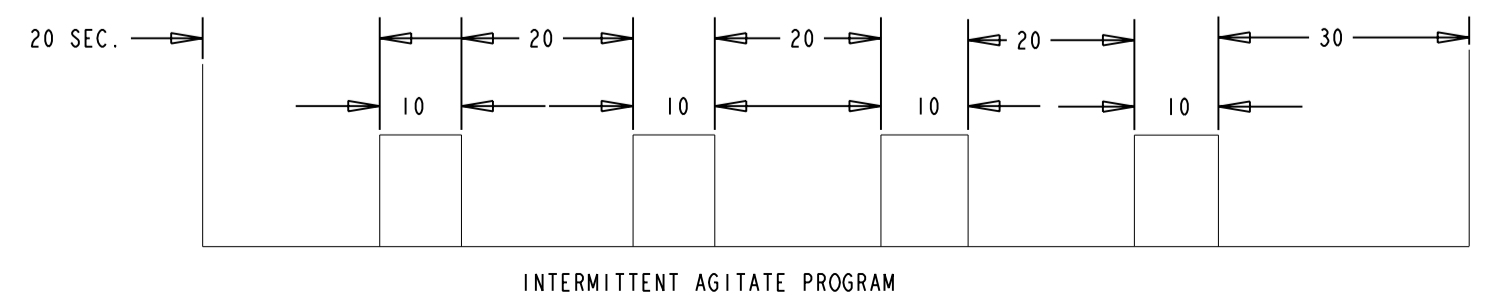

LEGEND / LEGENDE / LEYENDA

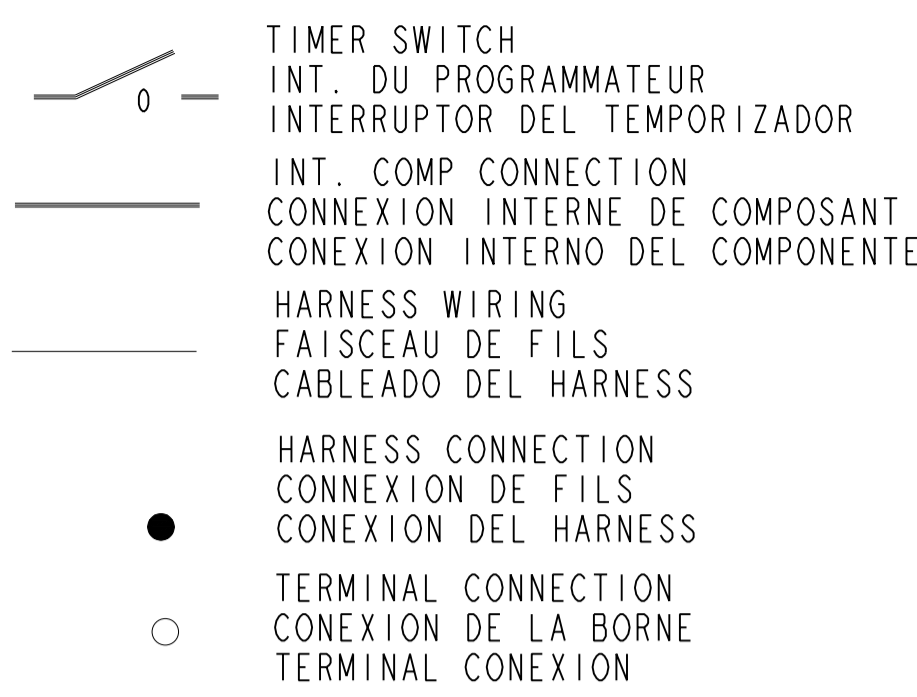

WASH RINSE / RINCAGE DE LAVAGE / ACLARACION DE LA COLADA

DRIVE MOTOR / MOTEUR / IMPULSOR MOTOR

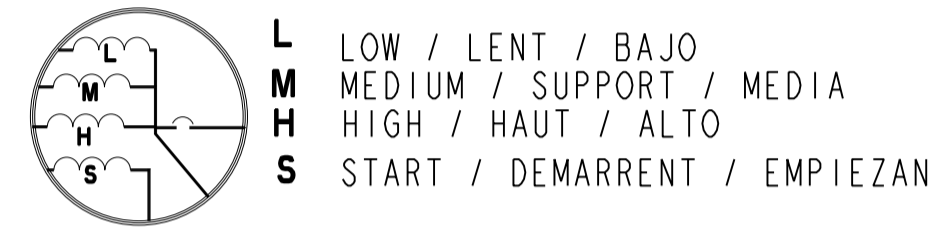

ATC SENSOR / CAPTEUR D'ATC / SENSOR DEL ATC

ATC BOARD / PANNEAU D'ATC / TARJETA DEL ATC

TSC TEMPERATURE SWITCH CHART
DIAGRAMME DE COMMUTATEUR DE LA TEMPERATURE
CARTA DE INTERRUPTOR DE LA TEMPERATURA

MANUFACTURED UNDER ONE OR MORE OF THE FOLLOWING US PATENTS:
4545947, 4555919, 4566295, 4572596, 4618193, 4624117, 4643350, 4646545, 4656844, 4656847, 4692981, 4693095, 4691293, 4700554, 4709951, 4715401, 4719769, 4754622, 4759202, 4774822, 4779431, 4782544, 4784666, 4785643, 4793820, 4807452, 4809524, 4835991, 4854559, 4856303, 4870988, 4880865, 4890465, 4891959, 4910979, 4945735, 4947516, 4969341, 4972134, 4977394, 4986093, 4987627, 5000016, 5031427, 5033277, 5074003, 5075613, 5113542, 5130624, 5150588, 5154071, 5166568, 5167722, 5172573, 5177659, 5191667, 5191668, 5191669, 5193361, 5199121, 5199281, 5200684, 5205141, 5219370, 5233718, 5249441, 5255844, 5257901, 5259217, 5269160, 5271251, 5297403, 5305485, 5312138, 5314044, 5345637, 5345792, 5345793, 5359744, 5373715, 5460118, 5493745, 5504955, 5507053, 5515965, 5582039, 5582199, 5651278, 5671494, 5765404, 5784902, 5791167, 5836180, 5852942, 5875655, 5878602, 5883490, 5946946, 6065171, 6070282, 6105403, 6115863, 6125490, 6185774, 6212722, 6227013, 6227014, 6269666, 6347645, 6365363, 6393872, 6430971, 6505370, 6314263, 6375390, 6381140, 6423740, 6426686, 6456572, 6459844, 6463631, 6465308

MANUFACTURADO BAJO UNA O MAS DE LAS SIGUIENTES PATENTES MEXICANAS:
159840, 159983, 161144, 163722, 164305, 164407, 165938, 165992, 170221, 174138, 174478, 174483, 177764, 177766, 181185, 182183, 182396, 182632, 187728, 189682, 189766, 192502, 192503, 198393, 199844, 2043393, 2056969, 2086151, 276618, 205519, 211042

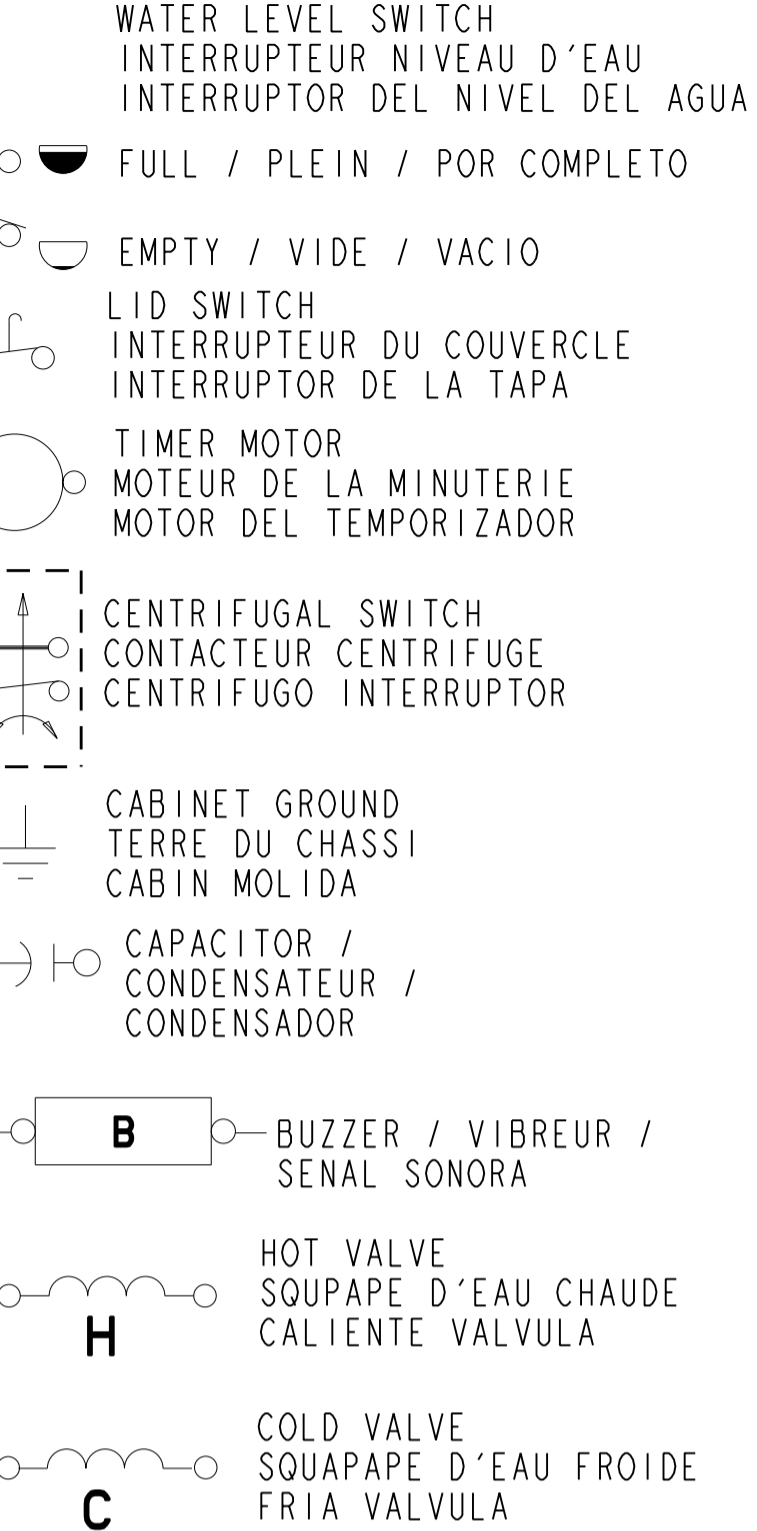

TIMER KNOB PUSH OFF ALL TIMER SWITCHES OPEN
BOUTON DE LA MINUTERIE ENFONCE (ARRET) - TOUS LES AUTRES COMMUTATEURS DE LA MINUTERIE OUVERTS
PERILLA DEL TEMPORIZADOR OPRIMIDA (APAGADO) - TODOS LOS INTERRUPTORES DEL TEMPORIZADOR ABIERTOS

| | |
|--|-----------------------------|
| PART NO. NUMERO DE PIECE NUMERO DE PIEZA | REV REVISION REVISION |
| 8572889 | REL |

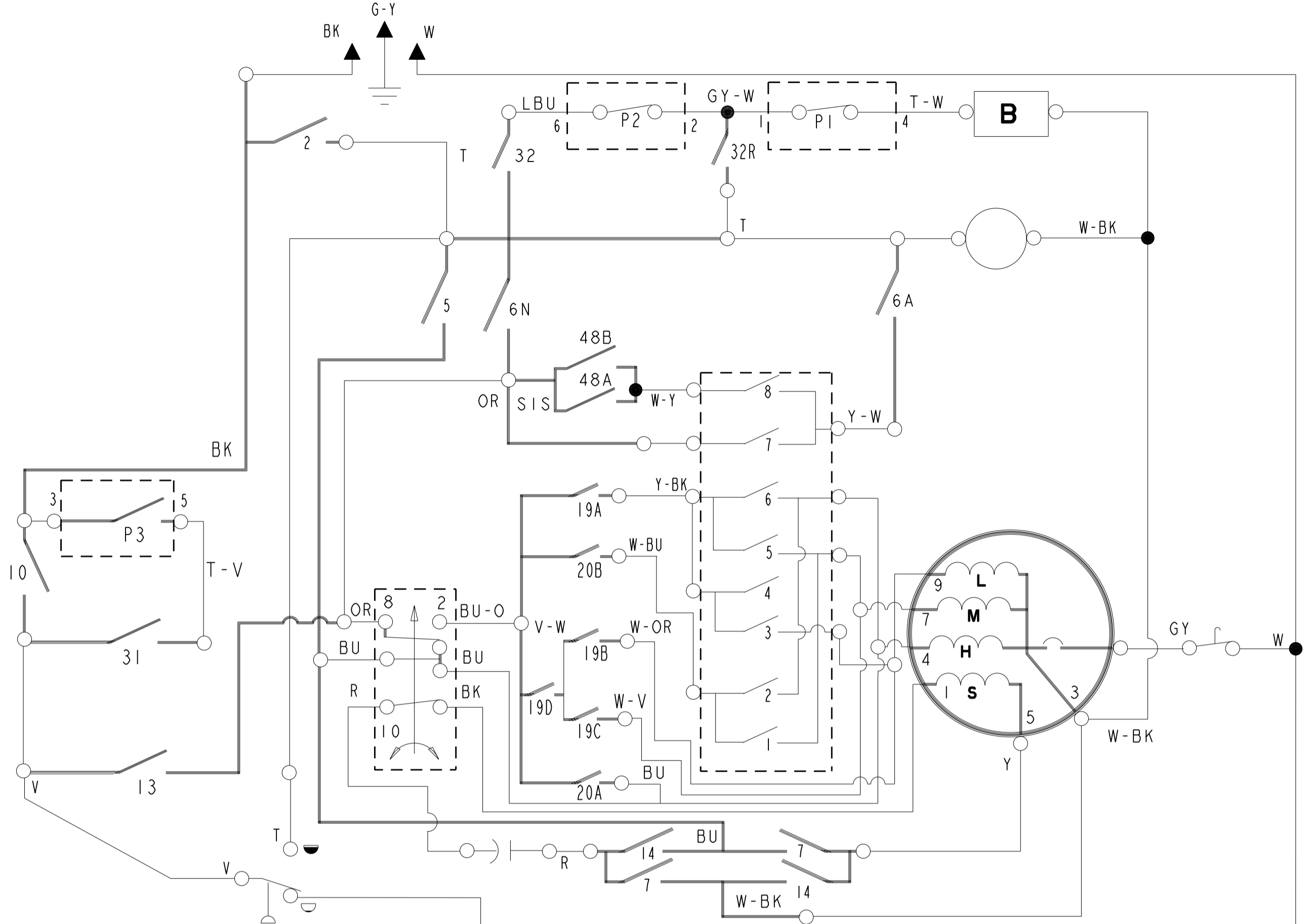

| FABRIC SELECT MOTOR SPEED SWITCH COMMUTATEUR DE VITESSE DE MOTEUR CHOISI DE TISSU INTERRUPTOR DE LA VELOCIDAD DEL MOTOR SELECTO DE LA TELA | | | | | | | | | | |
|--|---|----------------------------|---|----|----|----|----|----|----|----|
| FABRIC SELECT DIAL CADRAN CHOISI DE TISSU DIAL SELECTO DE LA TELA | MOTOR SPEED VITESSE DE MOTEUR VELOCIDAD DEL MOTOR | | CLOSED SWITCHES FERME COMMUTATEUR CERRADO INTERRUPTOR | | | | | | | |
| | AGITATE AGITENT AGITAN | SPIN ROTATION VUELTA | S1 | S2 | S3 | S4 | S5 | S6 | S7 | S8 |
| HANDWASH / WOOL LAVAGE DE MAIN/LAINES COLADA DE LA MANO/LANAS | INT LOW INT LENT INT BAJO | MEDIUM SUPPORT MEDIA | X | | X | | | | | X |
| DELICATE SENSIBLE DELICADO | LOW LENT BAJO | MEDIUM SUPPROT MEDIA | X | | X | | | | X | |
| KNIT/BLENDS HACEN PUNTO/MELANGES TRICOTENT/MEZCLAS | MEDIUM SUPPORT MEDIA | MEDIUM SUPPORT MEDIA | X | | | X | X | | X | |
| QUICK WASH RAPIDE LAVAGE RAPIDA COLADA | MEDIUM SUPPORT MEDIA | HIGH HAUT ALTO | | X | | X | X | | X | |
| COTTON/HEAVY DUTY COTON RESISTANT ALGODON RESISTENTE | HIGH HAUT ALTO | HIGH HAUT ALTO | | X | | X | | X | X | |
| CASUAL/PERMANENT PRESS OCCASIONEL/SYNTHETIQUES OCASIONAL/PERMANENTE PRENSA | HIGH HAUT ALTO | MEDIUM SUPPORT MEDIA | X | | | X | | X | X | |

| OPTION SWITCH CHART DIAGRAMME DE COMMUTATEUR D'OPTION CARTA DEL INTERRUPTOR DE LA OPCION | | | | |
|--|--------------------------------|----|----|----|
| EXTRA RINSE SUPPLEMENTAIRE RINCAGE ADICIONAL ACLARACION | BUZZER/VIBREUR SENAL SONORA | P1 | P2 | P3 |
| 1 OFF/ARRET/DE | OFF/ARRET/DE | | X | |
| 2 ON/SUR/EN | OFF/ARRET/DE | | | X |
| 3 OFF/ARRET/DE | ON/SUR/EN | X | X | |
| 4 ON/SUR/EN | ON/SUR/EN | X | | X |

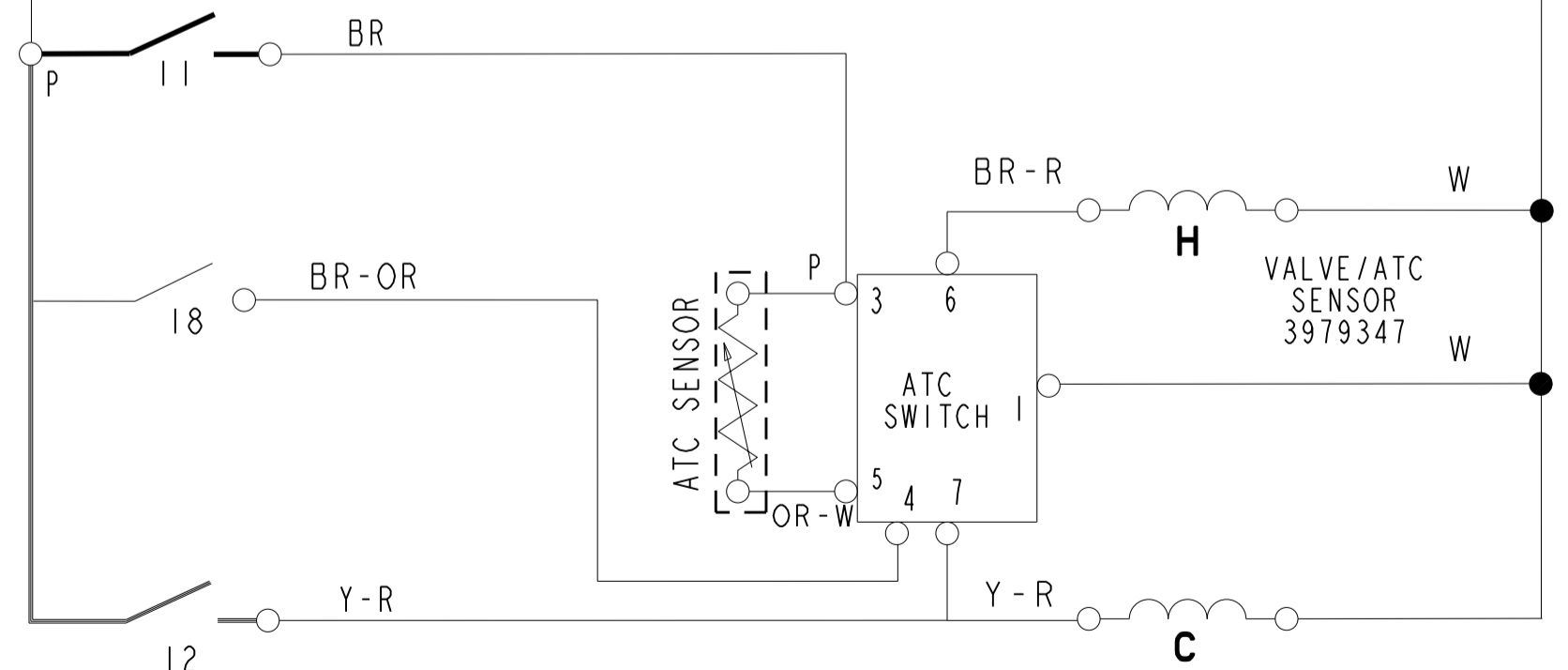

| TSC | | PRE-WASH CYCLE | OTHER CYCLES |
|-----|--------------|-------------------|-----------------|
| POS | WASH / RINSE | TEMPS | TEMPS |
| 1 | H/C | H/C | 105° F/C |
| 2 | W/C | 80° F/C | 80° F/C |
| 3 | C/C | 65° F/C | 65° F/C |
| 4 | C/C | C/C | C/C |