

LEGEND

- COMPONENT MAY OR MAY NOT BE USED
- TIMER CONSTRUCTION
- TERMINAL CONNECTION
- SPLICE
- 8 IN LINE CONNECTION

TIMER POSITION	TIMER SWITCH					
	TM-OR	TM-WB	BK-BU-V	BK-BU	BK-R	T-W
AUTO-REGULAR						
AUTO-SOFT/LOW HEAT						
COOL DOWN AIR	○	○	■			
END OF CYCLE						
TIMED-REGULAR						
TIMED-SOFT/LOW HEAT						
GUARD					+	

MANUFACTURED UNDER ONE OR MORE OF THE FOLLOWING U.S. PATENTS:

3,702,030	3,890,720	4,132,008
3,762,064	3,959,891	4,385,452
3,769,716	3,962,617	4,430,809
3,815,258	4,003,613	4,821,535
3,889,392	4,086,709	

CAUTION: LABEL ALL WIRES PRIOR TO DISCONNECTION WHEN SERVICING CONTROLS. WIRING ERRORS CAN CAUSE IMPROPER AND DANGEROUS OPERATION. VERIFY PROPER OPERATION AFTER SERVICING.

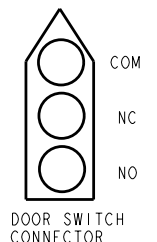
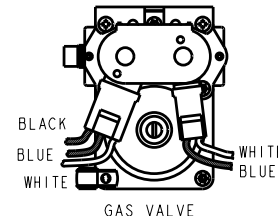
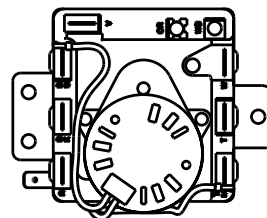
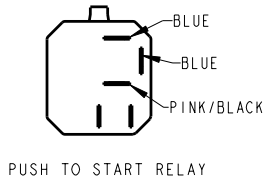
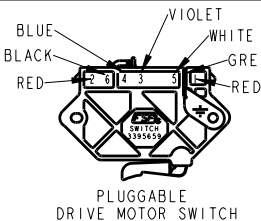
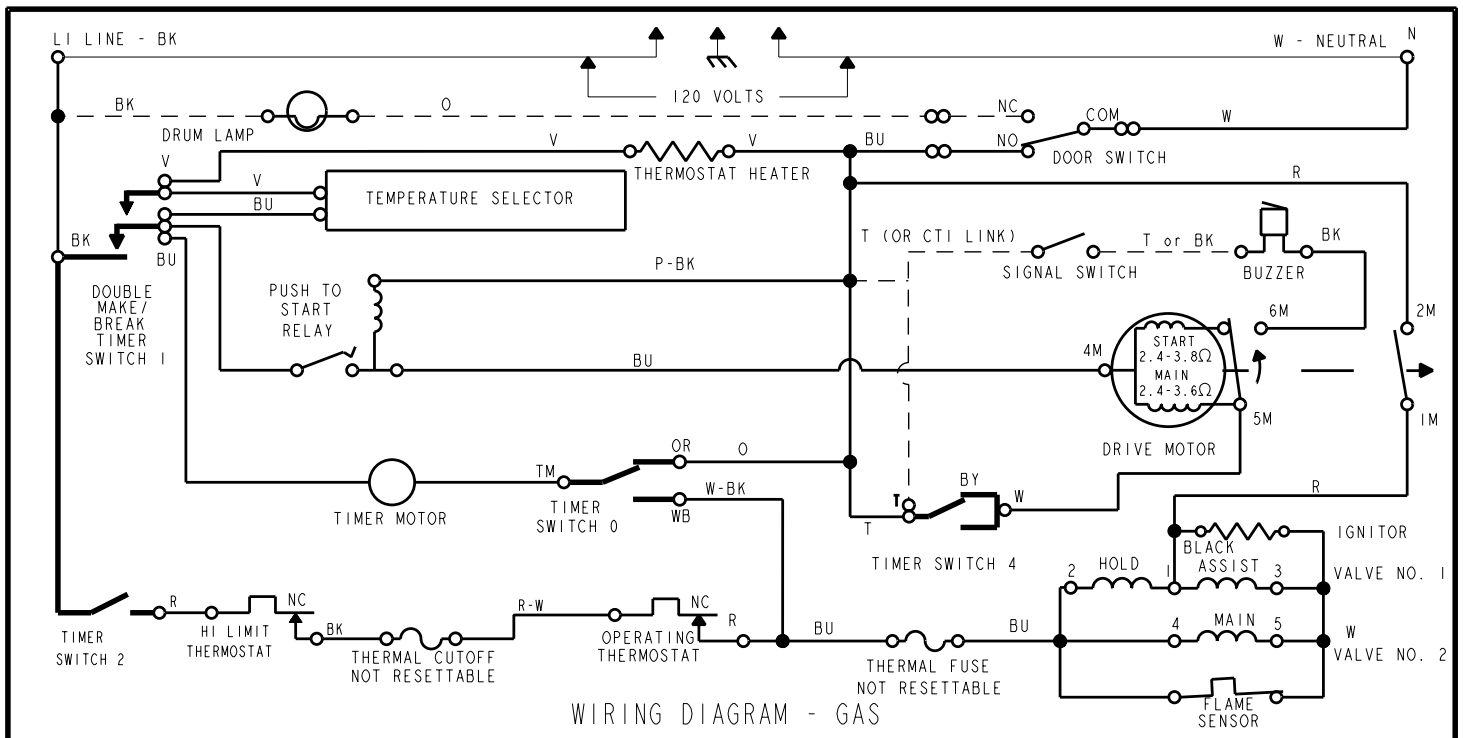
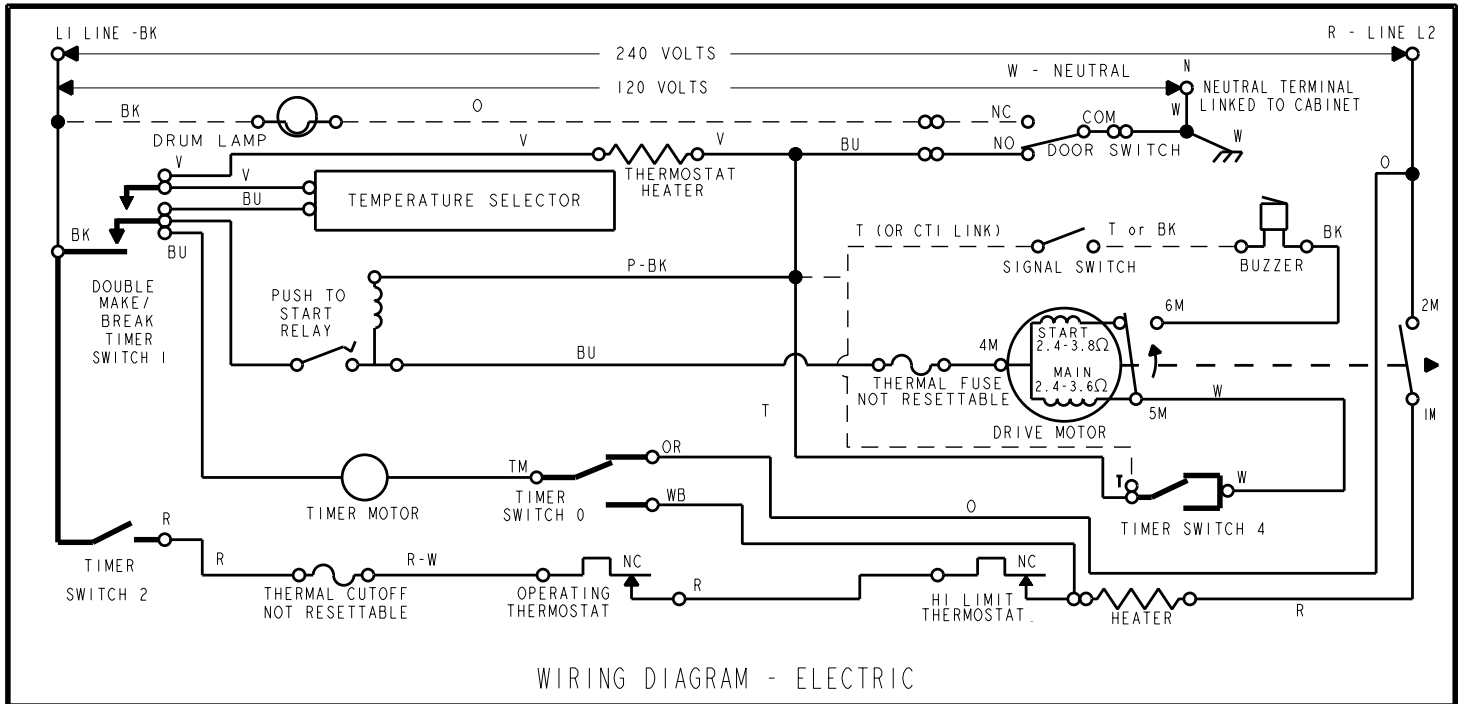

PART NO.
8576817
REV B