

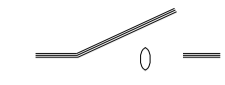















LEGEND / LEGENDE / LEYENDA

-  TIMER SWITCH
INT. DU PROGRAMMATEUR
INTERRUPTOR DEL TEMPORIZADOR
-  INT. COMP CONNECTION
CONNEXION INTERNE DE COMPOSANT
CONEXION INTERNO DEL COMPONENTE
-  HARNESS WIRING
FAISCEAU DE FILS
CABLEADO DEL HARNESS
-  HARNESS CONNECTION
CONNEXION DE FILS
CONEXION DEL HARNESS
-  TERMINAL CONNECTION
CONEXION DE LA BORNE
TERMINAL CONEXION
-  WASH RINSE / RINCEGE DE LAVAGE
/ ACLARACION DE LA COLADA
-  DRIVE MOTOR / MOTEUR/ IMPULSOR MOTOR
-  L LOW / LENT / BAJO
M MEDIUM / SUPPORT / MEDIA
H HIGH / HAUT / ALTO
S START / DEMARRENT / EMPIEZAN
-  HOT VALVE
SQUAPE D'EAU CHAUDE
CALIENTE VALVULA
-  COLD VALVE
SQUAPE D'EAU FROIDE
FRIA VALVULA

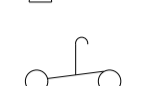
-  WATER LEVEL SWITCH
INTERRUPTEUR NIVEAU D'EAU
INTERRUPTOR DEL NIVEL DEL AGUA
-  FULL / PLEIN / POR COMPLETO
EMPTY / VIDE / VACIO
-  LID SWITCH
INTERRUPTEUR DU COUVERCLE
INTERRUPTOR DE LA TAPA
-  TIMER MOTOR
MOTEUR DE LA MINUTERIE
MOTOR DEL TEMPORIZADOR
-  CENTRIFUGAL SWITCH
CONTACTEUR CENTRIFUGE
CENTRIFUGO INTERRUPTOR
-  CABINET GROUND
TERRE DU CHASSI
CABIN MOLIDA
-  CAPACITOR / CONDENSATEUR /
CONDENSADOR
-  B BUZZER / VIBREUR / SENAL SONORA
-  TSC TEMPERATURE SWITCH CHART
DIAGRAMME DE COMMUTATEUR DE LA TEMPERATURE
CARTA DE INTERRUPTOR DE LA TEMPERATURA
-  NOT USED ON ALL MODELS

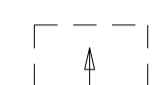
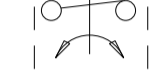
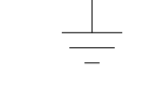
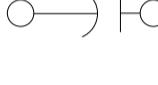
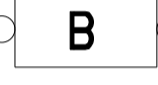
TIMER KNOB PUSH OFF
ALL TIMER SWITCHES OPEN
TIRE POUR MARCHE Pousse POUR ARRETE
BOUTON-FOUSSOIR DU PROGRAMMATEUR
LOS INTERRUPTORES SE ABREN
CUANDO LA PERILLA EMPUJO DE

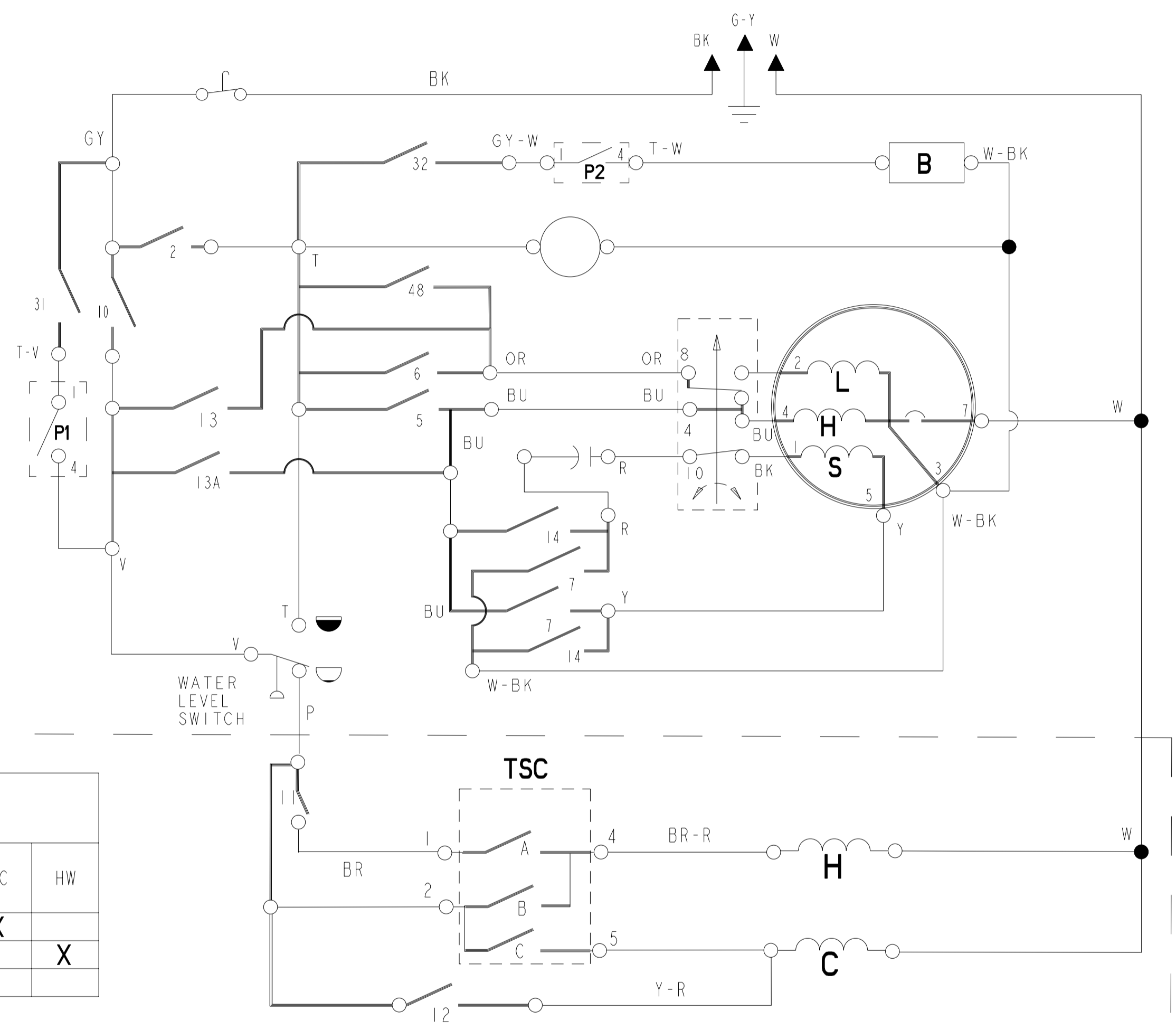

MANUFACTURED UNDER ONE OR MORE OF THE FOLLOWING US PATENTS:

4545947,	4555919,	4566295,	4572596,	4618193,	4624117,	4643350,
4646545,	4656844,	4656847,	4692987,	4693095,	4697293,	4700554,
4709951,	4715401,	4719769,	4754622,	4759202,	4774822,	4779431,
4782544,	4784666,	4785643,	4793820,	4807452,	4809524,	4835991,
4854559,	4856303,	4870988,	4888965,	4890465,	4891959,	4910979,
4945735,	4947516,	4969341,	4972134,	4977394,	4986093,	4987627,
5000016,	5031427,	5033277,	5074003,	5075613,	5113542,	5130624,
5150588,	5154071,	5166568,	5167722,	5172573,	5177659,	5191667,
5191668,	5191669,	5193361,	5199127,	5199281,	5200684,	5205141,
5219370,	5233718,	5249441,	5255844,	5257901,	5259217,	5269160,
5271251,	5297403,	5305485,	5312138,	5314044,	5345637,	5345792,
5345793,	5359744,	5373715,	5460018,	5493745,	5504955,	5507053,
5515565,	5582039,	5582199,	5651278,	5671494,	5765404,	5784902,
5791167,	5836180,	5852942,	5875655,	5878602,	5883490,	5946946,
6065171,	6070282,	6105403,	6115863,	6125490,	6185774,	6212722,
6227013,	6227014,	6269666,	6347645,	6363563,	6393872,	6430971,
6505370,	6597144,	6604298,	6685241,	6732447,	6784673,	6819255,
6840068,	6846790,	6860032,	6863197,	6900166,	6964360,	6966204,
6973740,	6973515,	7020985,	7080464,	7097667,	7314263,	7375390,
D381140,	D423740,	D426686,	D456572,	D459844,	D463631,	D465308,
D474566,	D495453,	D518250,	D502577,	D514756,	D521196,	D523595,
D524001,	D527853					

MANUFACTURED UNDER ONE OR MORE OF THE FOLLOWING CANADIAN PATENTS:

FABRIQUE SOUS UN OU PLUSIEURS DES BREVETS CANADIENS SUIVANTS:

1228410,	1233039,	1233658,	1282557,	1287338,	1288966,	1298988,
1301469,	1306367,	1313770,	2018975,	2022266,	2043393,	2056969,
2086151,	D76618					

MANUFACTURADO BAJO UNA O MAS DE LAS SIGUIENTES PATENTES MEXICANAS:

159840,	159983,	161744,	163722,	164305,	164407,	165938,
165992,	170221,	174138,	174478,	174483,	177764,	177766,
181185,	182183,	182396,	182632,	187728,	189682,	189766,
192502,	192503,	198393,	199844,	205519,	211042	

TSC
3950347

SWITCH COMMUTATEUR CAMBIAN	WW	CC	WC	HC	HW
A			X	X	
B	X				X
C	X	X	X		

TSC
8578335

POS	WASH / RINSE	TEMP	
		WASH	RINSE
1	C/C	COLD	COLD
2	C/C	70°	COLD
3	W/C	93°	COLD
4	H/C	110°	COLD

EXTRA-RINSE
SUPPLEMENTAIRE RINCEGE
ADICIONAL ACLARACION
3949187

	P1
OFF/ARRET/DE	
ON / SUR / EN	X

END OF CYCLE SIGNAL
EXTREMITE DE SIGNAL
DE CYCLE
EXTREMO DE LA SENAL
SENAL DEL CICLO
3949180

	P2
OFF ARRET DE	
ON SUR EN	X

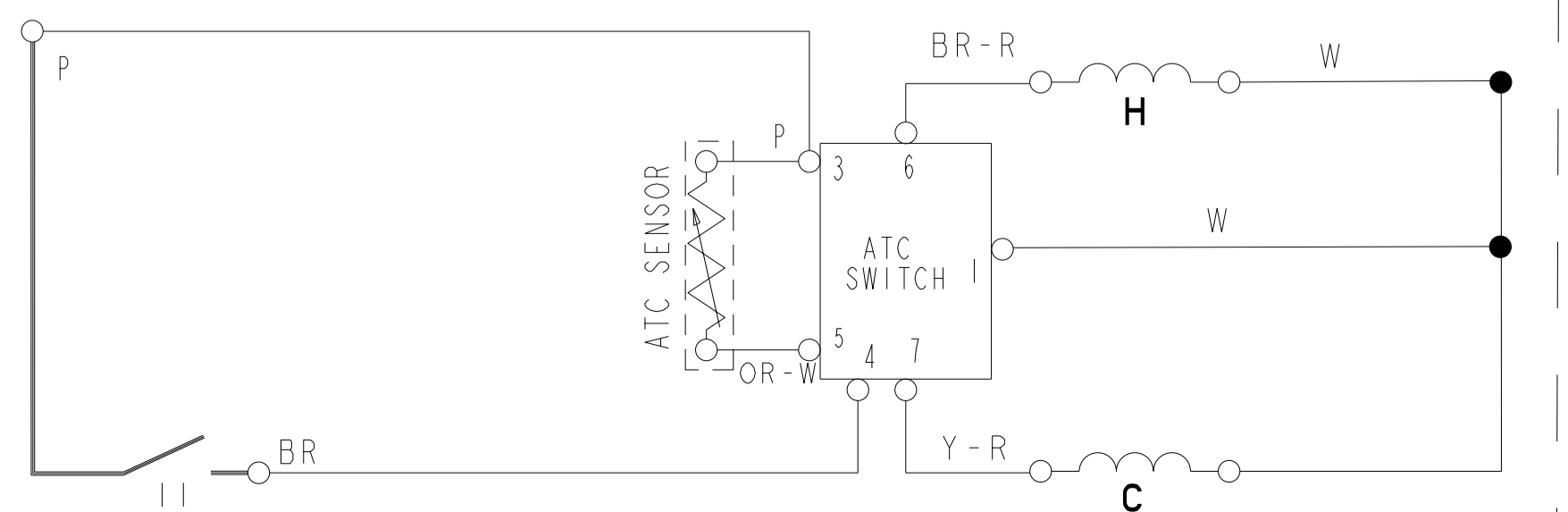

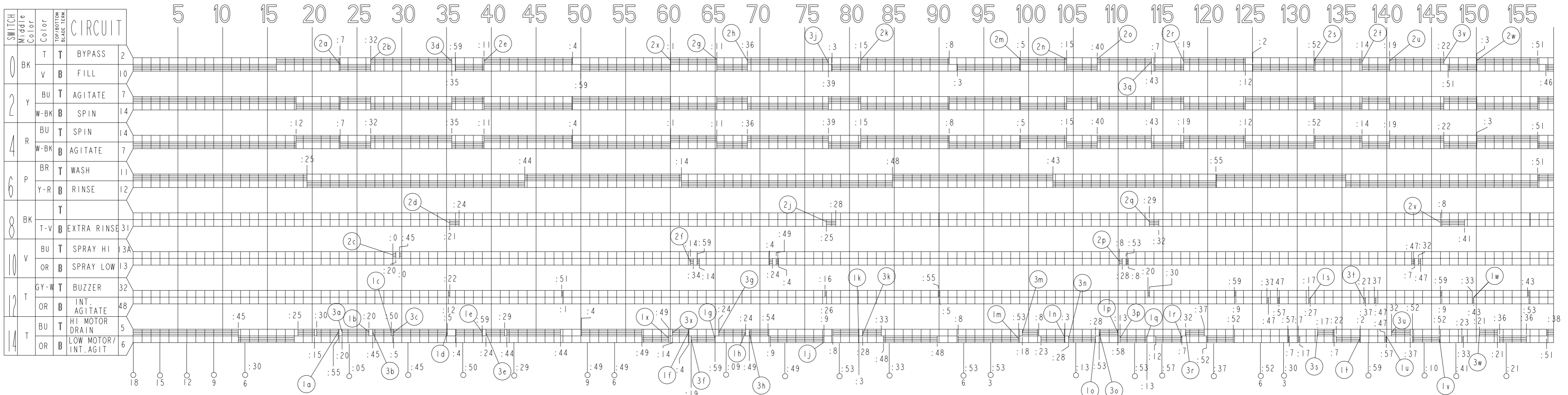

KEY

□ CONTACT OPEN ON CHART
 ■ CONTACT CLOSED ON CHART
 ∩ DIAL-IN LOCATION

ENGLISH	FRENCH	SPANISH
AGITATE	AGITER	AGITAN
BLEACH	BLANCHIMENT	BLANQUEO
BUZZER	VIBEUR	SENAL SONORA
BYPASS	DERIVATION	PUENTE
DRAIN	VIDENT	DRENAN
EXTRA RINSE	RINCAGE DE PLUS	ADICIONAL ACLARACION
FILL	REPLISSAGE	LLENAN
HIGH	HAUT	ALTO
INT AGITATE	AGITER INTERMITTENT	INTERMITENTE AGITE
LO	LENT	BAJO
MED	MED	MEDIA
MOTOR	MOTEUR	MOTOR
NORMAL	NORMALE	NORMAL
PERMANENT PRESS	SYNTHETIQUES	PERMANENT PRENSA
PREWASH	PRE LAVAGE	PRE COLADA

ENGLISH	FRENCH	SPANISH
RINSE	RINCAGE	ACLARACION
SOAK	IMBIBERT	REMOJAN
SPIN	ESSORAGE	VUELTA
SPRAY	CICLAGE	AEROSOL
WASH	LAVAGE	COLADA
TIMED FILL	SYNCHRONISES REPLISSAGE	SINCRONIZADO TERRAPLEN
1/2 TUB DRAIN	1/2 COVETTE VID	DREN DE LA TINA DEL 1/2
FAB. SOFTNER	RAMOLLISSANT DE TISSU	SUAVIZADOR DE LA TELA
DETERGENT	DETERGENT	DETERGENTE
ULTRA CLEAN	ULTRA PROPRE	ULTA LIMPIO

