

120 SECONDS PER STEP

MACHINE FUNCTION		DELICATE	PERMANENT PRESS	PREWASH	NORMAL
FILL-AGITATE WASH LOW			FILL - AGITATE WASH HI	FILL - AGITATE WASH HI	FILL - AGITATE WASH HI
DRAIN			DRAIN	DRAIN	LO
SPRAY - SPIN LOW			SPIN LO	SPIN HI	DRY - AGITATE
FILL - AGITATE RINSE LOW			FILL - AGITATE RINSE HI		DRAIN
DRAIN			DRAIN		SPIN HI
SPIN LOW			SPIN LO		FILL - AGITATE RINSE HI
OFF			OFF	OFF	DRAIN
					SPRAY
					SPIN HI
					OFF

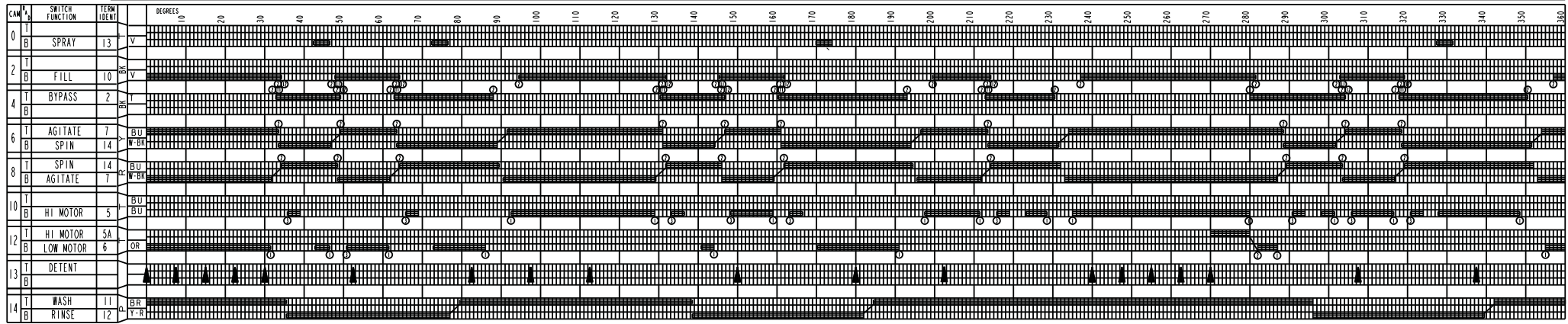

INTERVAL NUMBER	INTERVAL STEP	ACCUMULATED DEGREES
1	1.5°	0.00°
2	1.5°	1.50°
3	1.5°	3.00°
4	1.5°	4.50°
5	1.5°	6.00°
6	1.5°	7.50°
7	1.5°	9.00°
8	1.5°	10.50°
9	1.5°	12.00°
10	1.5°	13.50°
11	1.5°	15.00°
12	1.5°	16.50°
13	1.5°	18.00°
14	1.5°	19.50°
15	1.5°	21.00°
16	1.5°	22.50°
17	1.5°	24.00°
18	1.5°	25.50°
19	1.5°	27.00°
20	1.5°	28.50°
21	1.5°	30.00°
22	1.5°	31.50°
23	1.5°	33.00°
24	1.5°	34.50°
25	1.5°	36.00°
26	1.5°	37.50°
27	1.5°	39.00°
28	1.5°	40.50°
29	1.5°	42.00°
30	1.5°	43.50°
31	1.5°	45.00°
32	1.5°	46.50°
33	1.5°	48.00°
34	1.5°	49.50°
35	1.5°	51.00°
36	1.5°	52.50°
37	1.5°	54.00°
38	1.5°	55.50°
39	1.5°	57.00°
40	1.5°	58.50°
41	1.5°	60.00°
42	1.5°	61.50°
43	1.5°	63.00°
44	1.5°	64.50°
45	1.5°	66.00°
46	1.5°	67.50°
47	1.5°	69.00°
48	1.5°	70.50°

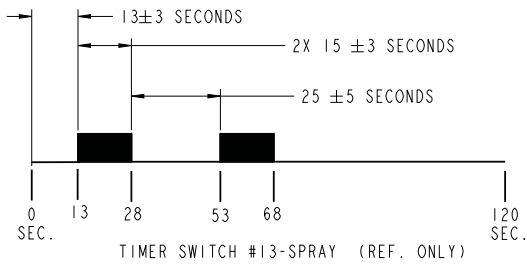

LEGEND	LEGENDE	LEYENDA	LEGEND	LEGENDE	LEYENDA
1/2 TUB DRAIN	1/2 COVETTE VID	DREN DE LA TINA DEL 1/2	SWITCH FUNCTION	COMMUTEZ LA FONCTION	CAMBIE LA FONCTION
SPRAY	GICLAGE	AEROSOL	CAM	CAME	LEVA
BYPASS	DERIVATION	PUENTE	OFF	ARRÊT	DE
FILL	REPLISSAGE	LLENAN	COOL DOWN	REFROIDISSEZ	REFRESQUESE ABAJO
AGITATE	AGITER	AGITAN	SPIN LOW	ROTATION BASSE	VUELTA BAJA
SPIN	ESSORAGE	VUELTA	RINSE LOW	RINCAGE BAS	ACLARACION BAJA
HI MOTOR	MOTEUR RAPIDE	ALTO MOTOR	WASH LOW	LAVAGE BAS	COLADA BAJA
LOW MOTOR	MOTEUR BAS	BAJO MOTOR	WASH HI	LAVAGE HAUT	COLADA ALTA
WARM/COLD	CHAUDE/FROIDE	CALIENTESE/FRIO	SPIN HI	ROTATION HAUTE	VUELTA ALTA
WASH	LAVAGE	COLADA	CASUAL	OCCASIONEL	OCASIONAL
RINSE	RINCAGE	ACLARACION	QUICK	VITE	APRISA
DRAIN	VIDENT	DRENAN	NORMAL	NORMALE	NORMAL
DRY/AGITATE	SECHER/AGITER	SECO/AGITAN	TERMINAL IDENTIFIER	TERMINAL IDENTIFICATEUR	TREMINAL IDENTIFICADOR
PRE WASH	PRE LAVAGE	PRE COLADA	STEP	ETAPE	PASO DE PROGRESION
SOAK	IMBIBENT	REMOJAN	SECONDS	SECONDES	SEGUNDOS
DELICATE	SENSIBLE	DELICADO			
PERMANENT PRESS	SYNTHETIQUES	PERMANENTE PRENSA			
REGULAR	REGULIER	REGULAR			
HEAVY	LOURD	PESADO			
EXTRA RINSE	SUPPLEMENTAIRE RINCAGE	ADICIONAL ACLARACION			
MACHINE FUNCTION	FUNTION DE MACHINE	FUNCIÓN DE LA MAQUINA			

TIMER KNOB PUSH OFF ALL TIMER SWITCHES OPEN
 BOUTON DE LA MINUTERIE ENFONCE (ARRET)-TOUS LES
 AUTRES COMMUTEURS DE LA MINUTERIE OUVERTS
 PERILLA DEL TEMPORIZADOR OPRIMIDA (APAGADO)-TODOS
 LOS INTERRUPTORES DEL TEMPORIZADOR ABIERTOS

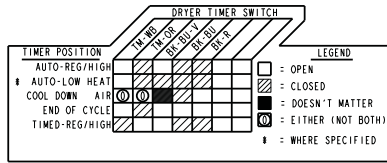

TSC W1014118			
POS	WASH / RINSE	WASH TEMP	RINSE TEMP
1	C/C	COLD	COLD
2	C/C	70°	COLD
3	W/C	78°	COLD
4	H/C	105°	COLD

PART No. PIECE N° PIEZA N°	REV. REV. REV.
W10362946	A

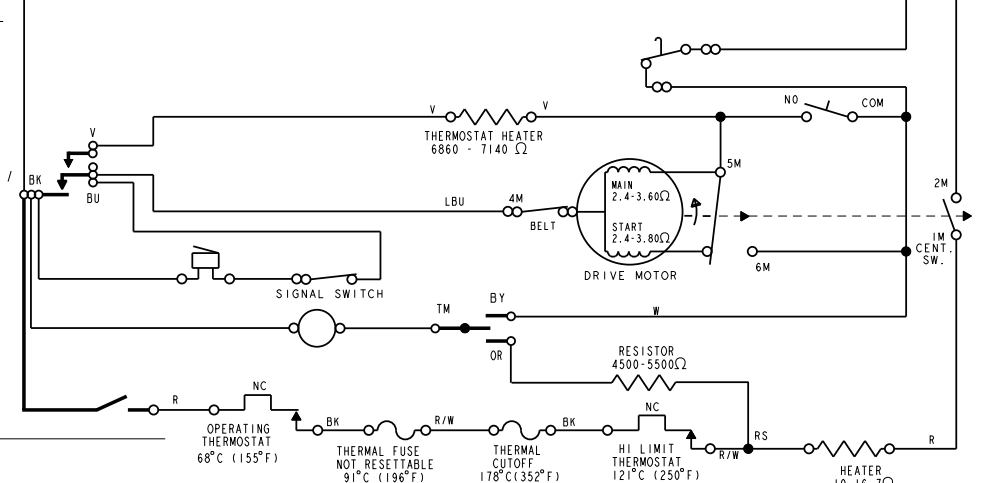
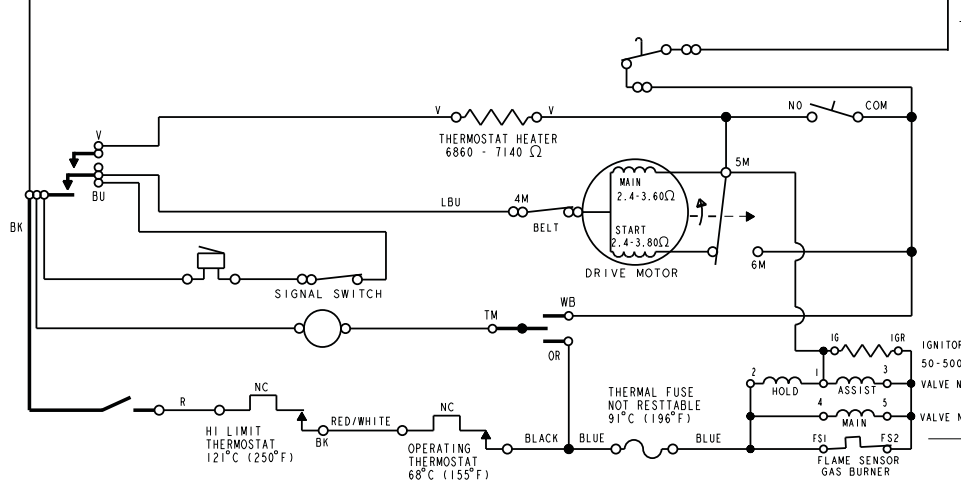
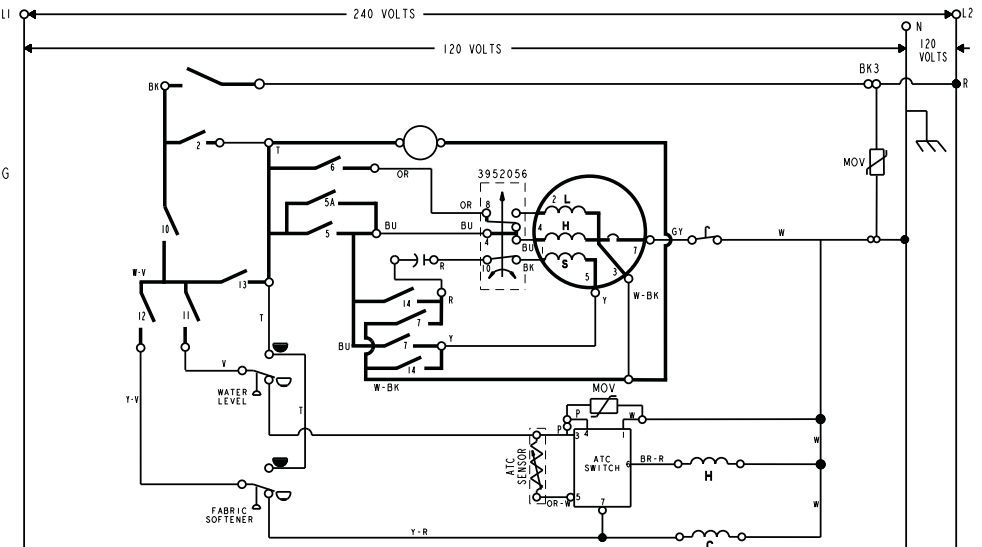
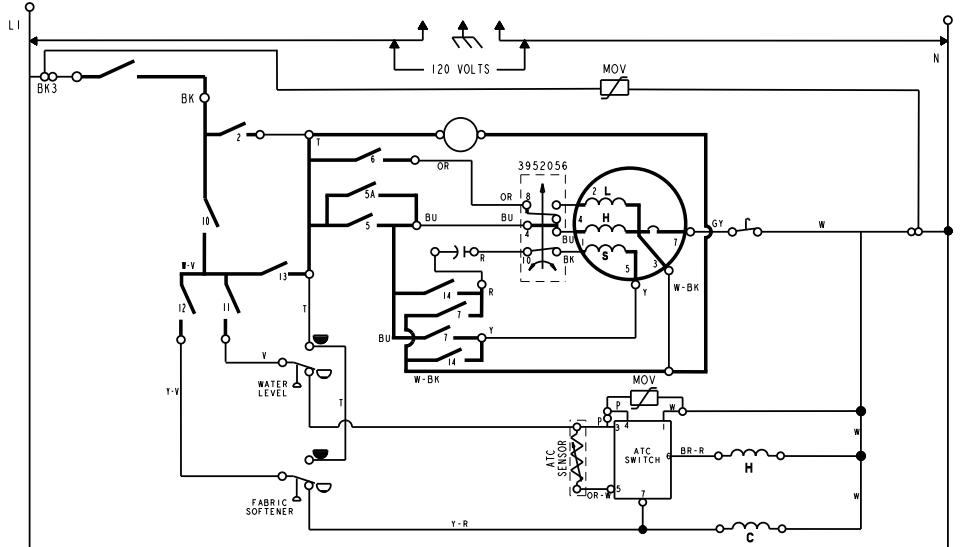

LEGEND / LEGENDE / LEYENDA

- | | | | |
|--|---|---|---|
| TIMER SWITCH
INT. DU PROGRAMMATEUR
INTERRUPTOR DEL TEMPORIZADOR | TIMER MOTOR
MOTEUR DE LA MINUTERIE
MOTOR DEL TEMPORIZADOR | TSC TEMPERATURE SWITCH CHART
DIAGRAMME DE COMMUTEUR DE LA TEMPERATURE
CARTA DE INTERRUPTOR DE LA TEMPERATURA | BUZZER
VIBREUR
ZUMBADOR |
| INT. COMP. CONNECTION
CONNEXION INTERNE DE COMPOSANT
CONEXION INTERNO DEL COMPONENTE | LID SWITCH
INTERRUPTEUR DU COUVERCLE
INTERRUPTOR DE LA TAPA | DOOR SWITCH
COMMUTEUR DE PORTE
INTERRUPTOR DE LA PUERTA | WATER LEVEL SWITCH
INTERRUPTEUR NIVEAU D'EAU
INTERRUPTOR DEL NIVEL DEL AGUA |
| HARNESS WIRING
FAISCEAU DE FILS
CABLEADO DEL HARNESS | PUSH TO START
POUSSEZ AU DEBUT
EMPUJEZ AL COMIENZO | DRIVE MOTOR
MOTEUR
IMPULSOR MOTOR | FULL PLEIN
POR COMPLETO

EMPTY VIDE
VACIO |
| TERMINAL CONNECTION
CONNEXION DE LA BORNE
TERMINAL CONEXION | WASH RINSE
RINCAGE DE LAVAGE
ACLARACION DE LA COLADA | FLAME SENSOR
GAS BURNER | IGNITOR
ALLUMEUR
ENCENDEADOR |
| CABINET GROUND
TERRE DU CHASSI
CABIN MOLIDA | HOT VALVE
SOUPAPE D'EAU CHAUDE
CALIENTE VALVULA | CENTRIFUGAL SWITCH
CONTACTEUR CENTRIFUGE
CENTRIFUGO INTERRUPTOR | OPERATING THERMOSTAT
THERMOSTAT FONCTIONNANT
THERMOSTATO DE FUNCIONAMIENTO |
| | COLD VALVE
SOUPAPE D'EAU FROIDE
FRIA VALVULA | THERMAL FUSE NOT RESETTABLE
FUSIBLE THERMIQUE NON REGLABLE
FUSIBLE THERMAL NO RESTAURABLE | THERMAL CUTOFF
COUPEUR THERMIQUE
ATAJO THERMAL |
| | | HI LIMIT THERMOSTAT
HAUTE THERMOSTAT DE LIMITE
ALTA THERMOSTATO DEL LIMITE | SIGNAL SWITCH
COMMUTEUR DE SIGNAL
INTERRUPTOR DE LA SERIAL |
| | | RESISTOR
RESISTANCE
RESISTOR | THERMOSTAT HEATER
RECHAUFFEUR DE THERMOATAT
CALENTADOR DEL THERMOATATO |
| | | HEATER
RECHAUFFEUR
CALENTADOR | VALVE
SOUPAPE
VALVULA |
| | | VOLTS
VOLTS
VOLTIOS | |