



AD-400  
Pre-Installation Manual

American Dryer Corporation  
88 Currant Road / Fall River, MA 02720-4781  
Telephone: (508) 678-9000 / Cable: AMDRY  
Telex: 927520 AMDRY FRIV / Fax: (508) 678-9447

**Retain This Manual In A Safe Place For Future Reference**

Please read this manual carefully to thoroughly familiarize yourself with the pre-installation procedures necessary to make the installation of the AD-400 as trouble-free as possible.

American Dryer Corporation products embody advanced concepts in engineering, design and safety. If this product is properly maintained, it will provide many years of safe, efficient and trouble-free operation.

We have tried to make this manual as complete as possible and hope you will find it useful. However, since the time of printing, some of the information contained here may have been updated. ADC reserves the right to make changes from time to time, without notice or obligation, in prices and specifications and to change or discontinue models.

For replacement parts, service, or product information, contact:

the distributor from which the dryer was purchased  
or

American Dryer Corporation  
88 Currant Road Fall River, MA 02720-4781  
Telephone: (508) 678-9000 Fax: (508) 678-9447

When contacting your distributor or the ADC factory, be sure to give them the dryer model number and serial number.

**IMPORTANT:** Observe all safety precautions displayed on the equipment or specified in the Installation/Operators Manual included with the dryer.

# INTRODUCTION

The purpose of this pre-installation package is to provide information concerning the AD-400'S electrical & mechanical requirements, and preview its installation.

Electrically the AD-400 has been separated into a number of sections to allow for its manufacture, installation, and repair. Refer to the system's block diagram as the AD-400 features are described. Fig. 1

The Main Electrical Enclosure is the center of the AD-400 control. It contains an electrical panel, where all input signals are processed, and output signals are generated. There are six interface boxes and six motors connected to the main electrical enclosure. The interface boxes interconnect a number of input sensors and switches to the panel for processing, and output signals for machine status & control. Motors are for air circulation, tumbler rotation, lint extraction, and burner flame control. Most Input/Output (I/O) signals are terminated at the bottom of this panel.

A complete installation and operating instructions manual will be provided with the AD-400 dryer for operation, maintenance, and diagnostic information.

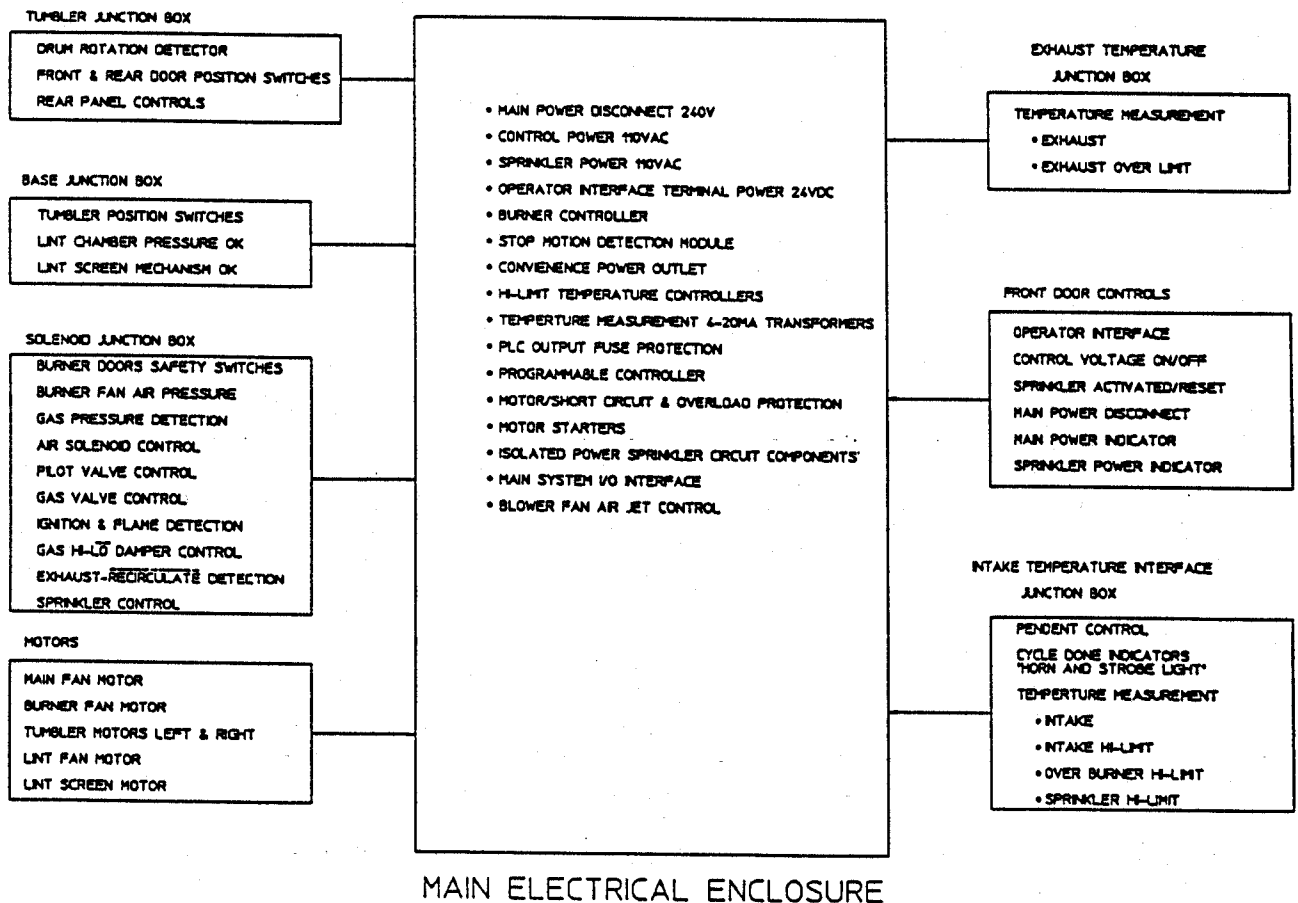

# Important Information

## RECEIVING AND HANDLING

The dryer is shipped in a protective wrap cover as a means of preventing damage in transit. Upon delivery, the dryer and protective packaging should be visually inspected for shipping damage. If any damage whatsoever is noticed, inspect further before delivering carrier leaves.

### Dryers Damaged in Shipment

1. The dryer should be inspected upon receipt and before it is signed for.
2. If there is suspected damage or actual damage, the trucker's receipt should be so noted.
3. If the dryer is damaged beyond repair, it should be refused. Those dryers which were not damaged in a damaged shipment should be accepted, but the number received and number refused must be noted on the receipt.
4. If you determine that the dryer was damaged after the trucker has left your location, you should call the delivering carrier's freight terminal immediately and file a claim. The freight company considers this concealed damage. This type of freight claim is very difficult to get paid and becomes extremely difficult when more than a day or two passes after the freight was delivered. It is your responsibility to file freight claims. Dryers/parts damaged in transit cannot be claimed under warranty.

Freight claims are the responsibility of the consignee, and all claims must be filed at the receiving end. ADC assumes no responsibility for freight claims or damages.

5. If you need assistance in handling the situation, please contact the traffic manager at American Dryer Corp. (ADC) at (508) 678-9000.

**IMPORTANT:** The dryer basket section must be transported and handled in an upright position at all times.

# Installation

## MOVING THE DRYER INTO POSITION/REASSEMBLY

The AD-400 dryer is shipped broken down into either two, three, or four pieces.

### 1. Two-Piece Shipment

In this method of shipment, the basket and base are shipped as one piece, and the control console comprises the second piece. Move both pieces into position by lifting them with cables through the eyebolts on top. These pieces may also be moved by lifting from underneath with a fork truck. The basket/base weighs about 6,600 pounds, and the control console weighs about 3,200 pounds. Put the sections together and match the seven (7) clearance holes in the base right side channels with the seven (7) 3/8-16 tapped holes in the left side of the control console. Use the 3/8-16 bolts provided with the dryer to bolt the two sections together. Remove the eight (8) 1/2-13 shipping bolts that fasten the basket section to the base. Remove the four (4) tilting piston panels to gain access to these shipping bolts.

### 2. Three-Piece Shipment

The basket section is shipped separately from the base, and the control console is shipped as the third piece.

Move the base into position with a fork truck. Lift the basket section onto the base by cables through the lifting eye bolts on top of the tumbler section. There is a 1-inch bolt in each corner of the base. These must pass through the 1-1/8-inch diameter holes in each corner of the tumbler section so that the tumbler section sits flat on the four (4) base piston clevis blocks. Use the four (4) sets of 1-inch nuts and washers provided to bolt the basket section to the base.

Make sure that the front of the basket section lines up with the front of the base. The small gear motor sits on the base front. The sprinkler piping is on the left side of the basket section.

Bolt the control console to this section as per the instructions in the previous two-piece shipment section.

### 3. Four-Piece Shipment

The basket section is shipped apart from the base, and the control console is broken down into two separate pieces.

Apply a bead of silicone to the top flanges of the lower control console assembly. A tube of silicone is included with the dryer. Lift the upper control console section onto the lower console section by cables

through the lifting eye bolts on top of the upper control console. Bolt these sections together with the 5/16-18 hardware provided. Assemble the rest of the dryer together using the information provided in the previous sections.

#### **4. Additional Reassembly**

The pendant arm now can be rebolted to the top of the control console. Pass the 5/16-18 bolts through the pendant arm tube and screw them into the weld nuts located on the top of the console.

# **PRE-STARTUP PREPARATION FOR OPERATION**

A technician from the factory will start up the dryer. The following items must be completed before the technician arrives.

1. The supply voltage must match the dryer voltage as stated on the aluminum dryer data label which is located on the inner right wall of the electric cabinet door.
2. A separately fused power supply must be connected into the safety sprinkler supply inlet connection.
3. Gas dryers
  - a. The gas supply must be either natural or L.P. gas, matching what is stated on the dryer data label.
  - b. The gas supply pressure must be between 7 and 13 inches water column for natural gas and 10 and 11 inches water column for L.P. gas. If the supply pressure is too high, then a pressure regulator must be installed on the gas piping upstream of the dryer.
4. A compressed air supply of 80 psi must be connected into the dryer's filter/lubricator/regulator.
5. The dryer exhaust duct must be vented to the outdoors.
6. On steam dryers, the steam supply line and condensate return line must be plumbed according to the requirements of this manual. The steam supply pressure cannot exceed 125 psi.
7. A water supply of 40 psi must be connected into the 1-inch sprinkler pipe connection.
8. The dryer must be lagged to the floor and leveled for proper operation.
9. A fresh air supply from the outdoors of 4,500 cfm must be available to the dryer.

# Connections

## 1. Compressed air supply

A minimum of 20 cubic feet per hour of 80 psi compressed air must be supplied to the dryer.

The compressed air supply must be connected into the 3/8-inch FPT fitting in the dryer's filter/lubricator/regulator which is located in the bottom back corner of the control console.

The filter bulb should be emptied monthly, and the oiler bulb should be refilled monthly with an SAE 150-200 SSU misting oil, such as Mobil DTE lightweight oil or equivalent. Do not use synthetic oils.

## 2. Gas Piping (gas-heated dryers only)

The gas connection to the dryer is made into the 1-1/2-inch FPT shut-off valve located in the bottom front corner of the control console.

The gas pressure supplied to the dryer must be between 7 inches and 13 inches water column for natural gas and between 10 inches and 11 inches water column for L.P. gas.

If the plant's gas pressure is higher than these values, then an external pressure regulator must be installed prior to the dryer to reduce the gas pressure to within the appropriate range.

The dryer must be connected to either natural or L.P. gas as indicated on the dryer data label located on the inner right wall of the electric cabinet door. If your gas supply does not match the type of gas for which the dryer was built, contact your distributor or the ADC factory.

The gas dryer piping installation must meet the National Fuel Gas Code ANSI Z223.1- (latest edition), as well as local codes and ordinances and must be done by a qualified technician.

Pipe joint compounds that resist the action of natural and L.P. gas **MUST** be used.

Test all pipe connections for leaks by brushing on a soapy water solution. **NEVER TEST FOR LEAKS WITH A FLAME.**

## 3. Exhaust Air Ducting

The dryer's exhaust air must be vented to the outdoors by the shortest route possible with the number of elbows kept to a minimum. The duct work should be designed and installed by qualified technicians.



Improperly designed duct work may reduce the airflow through the dryer, causing improper and unsafe drying conditions. The static pressure of the exhaust air in the duct work must not exceed 1.25 inches water column (3.1 millibar). The dryer exhausts 4,500 cfm of air during the drying cycle.

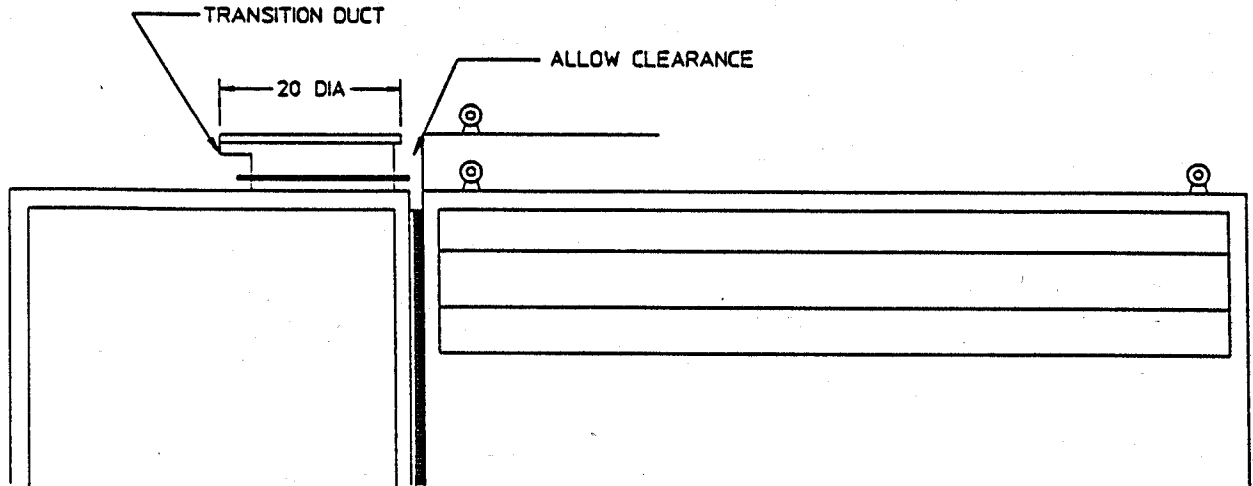

MAN0630

The exhaust vent connection is located on top of the console section of the dryer. It has a rectangular cross-section and is flanged.

The duct work connecting the vent to the outdoors must be a minimum of 20 inches in diameter for a round duct or 324 square inches for a rectangular duct (18 inches by 18 inches square duct would be sufficient).

A sheet metal transition piece is supplied to connect the 20-inch diameter exhaust duct to the dryer's exhaust vent connection. Care must be taken in locating this transition piece so that the tilting basket section does not hit the transition piece.

The duct work must be smooth on the inside with no projections from sheet metal screws or other obstructions which will collect lint. Inspection doors must be installed at strategic points in the duct work for periodic lint removal.

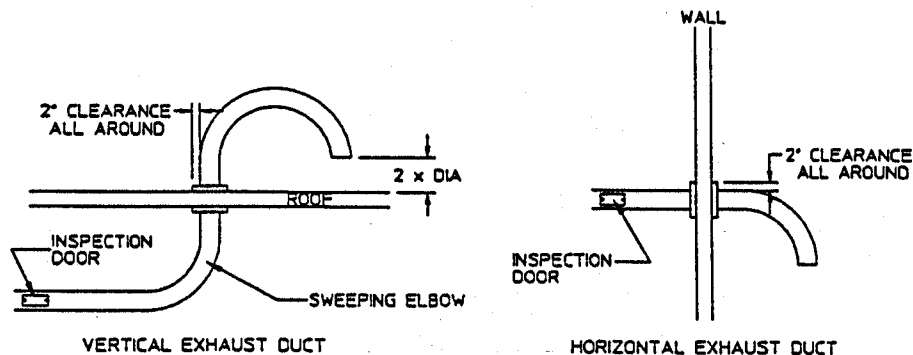

Use smooth sweeping elbows instead of sharp 90-degree elbows. The radius of an elbow should be at least 1-1/2 times the duct diameter.

When the exhaust duct goes through a combustible wall on a roof, leave a 2-inch clearance space between the exhaust ducting and the wall or roof.

When adding ducts, the duct to be added should overlap the duct to which it is to be connected. This will allow smoother airflow.

The end of the duct that leaves the building must be protected from the weather. For horizontal ducting, use a 90-degree turn down and for vertical duct work, use a 180-degree turn down. In either case, allow at least twice the diameter of the duct between the duct opening and nearest obstruction. (If the duct is rectangular, leave twice the smallest face dimension.)

**IMPORTANT:** Do not use screens or caps on the outside opening of the exhaust duct work. Screens will clog with lint and caps will restrict the exhaust airflow.

#### 4. Fresh Air Supply

The dryer takes 4,500 cfm of air from the room, heats it, draws it through the basket, and exhausts it out of the building. This 4,500 cfm of air must be replenished in the room for the dryer to operate properly.

An inadequate make-up air supply will lead to increased drying times and unsafe operating conditions.

#### 5. Steam Piping (steam dryers only)

It is your responsibility to have all steam plumbing connections made by a qualified professional to assure that the installation is adequate and conforms with local and state regulations or codes.

**IMPORTANT:** Failure to comply with the requirements stipulated in this manual can result in component failure which will void the warranty.

The steam inlet connection of the steam coil is 2 inches MPT, and the condensate outlet connection is 2 inches MPT. The working steam pressure of the dryer is 125 psi at 23 boiler horsepower. Supplying a lower steam pressure to the dryer will result in slower drying times. The condensate outlet can be reduced to 3/4-inch pipe.

This unit is not equipped with a steam valve. It utilizes an air damper bypass system and continuously charged coils. With this system, the coils will always be energized and hot. Upon a call for heat, the damper pivots about the steam coils, allowing the air to pass through the coils and closing off cool air. When the temperature in the dryer is satisfied, the damper will pivot back onto the coils, directing cool room air directly into the basket, bypassing the coils. With this system, heat and cooling are provided instantaneously; and consequently, there is a direct reduction in drying time and energy usage. In addition, the life of the steam coil will be extended because it is not constantly heating up and cooling down.

**NOTE:** No electrically operated steam valve is supplied, and none should be installed.

Adherence to the following instructions is necessary to eliminate coil failures due to water hammer caused by wet steam.

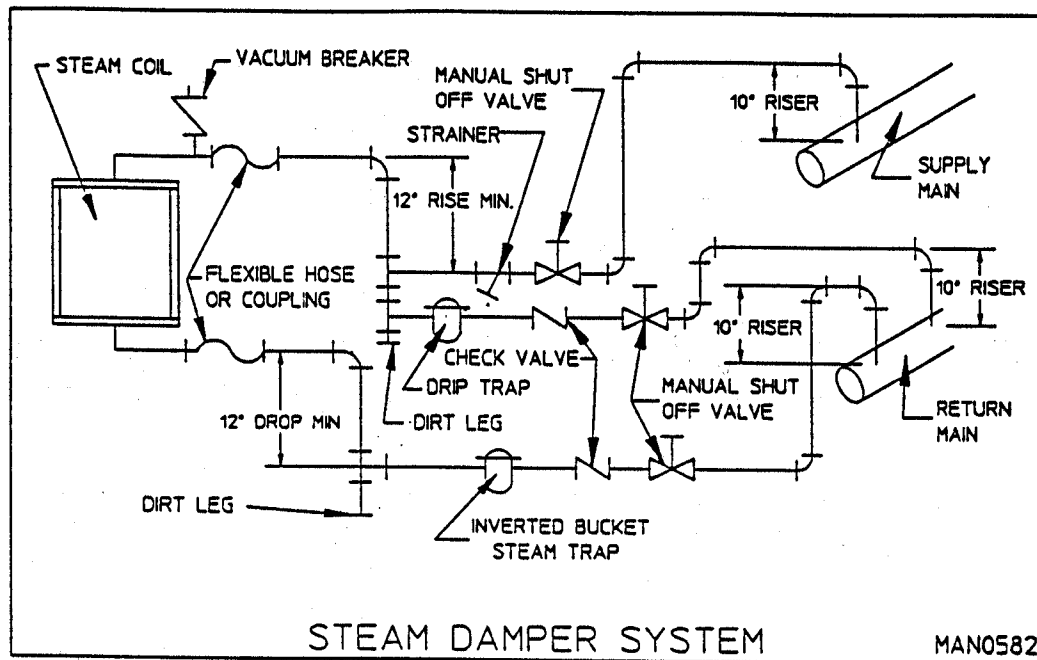

1. The presence of condensate in the steam supply will cause water hammer and subsequent steam coil failure. The steam supply connection into the main supply line must be made with a minimum 10-inch riser. This will prevent any condensate from draining towards the dryer.
2. The steam supply piping to the dryer must include a 12-inch rise, along with a drip trap and check valve. This will prevent any condensate from entering the steam coil.
3. Flexible hoses or couplings must be used. The dryer vibrates slightly when it runs, and this will cause the steam coil connections to crack if they are hard piped to the supply and return mains.
4. Shut-off valves for each dryer should be installed in the supply, return, and drip trap return lines. This will allow the dryer to be isolated from the supply and return mains if the dryer needs maintenance work.
5. Install an inverted bucket steam trap and check valve at least 12 inches below the steam coil and as near to the coil as possible.
6. A vacuum breaker should be installed in the supply piping as near to the dryer as possible. This will prevent the condensing steam from causing a vacuum inside the coil possibly damaging the coil.
7. The supply and return lines should be insulated. This will save energy and provide for the safety of the operator and maintenance personnel.
8. Water pockets in the supply line, caused by low points, will provide wet steam to the coil possibly causing coil damage. All horizontal runs of steam supply piping should be pitched 1/4 inch every foot

back towards the steam supply header, causing any condensate in the line to drain to the header. Install a bypass trap in any low point to eliminate wet steam.

### 7. Sprinkler Water Supply

A 40 psi supply of water must be connected into the 1-inch MPT sprinkler connection located on the left side of the base.

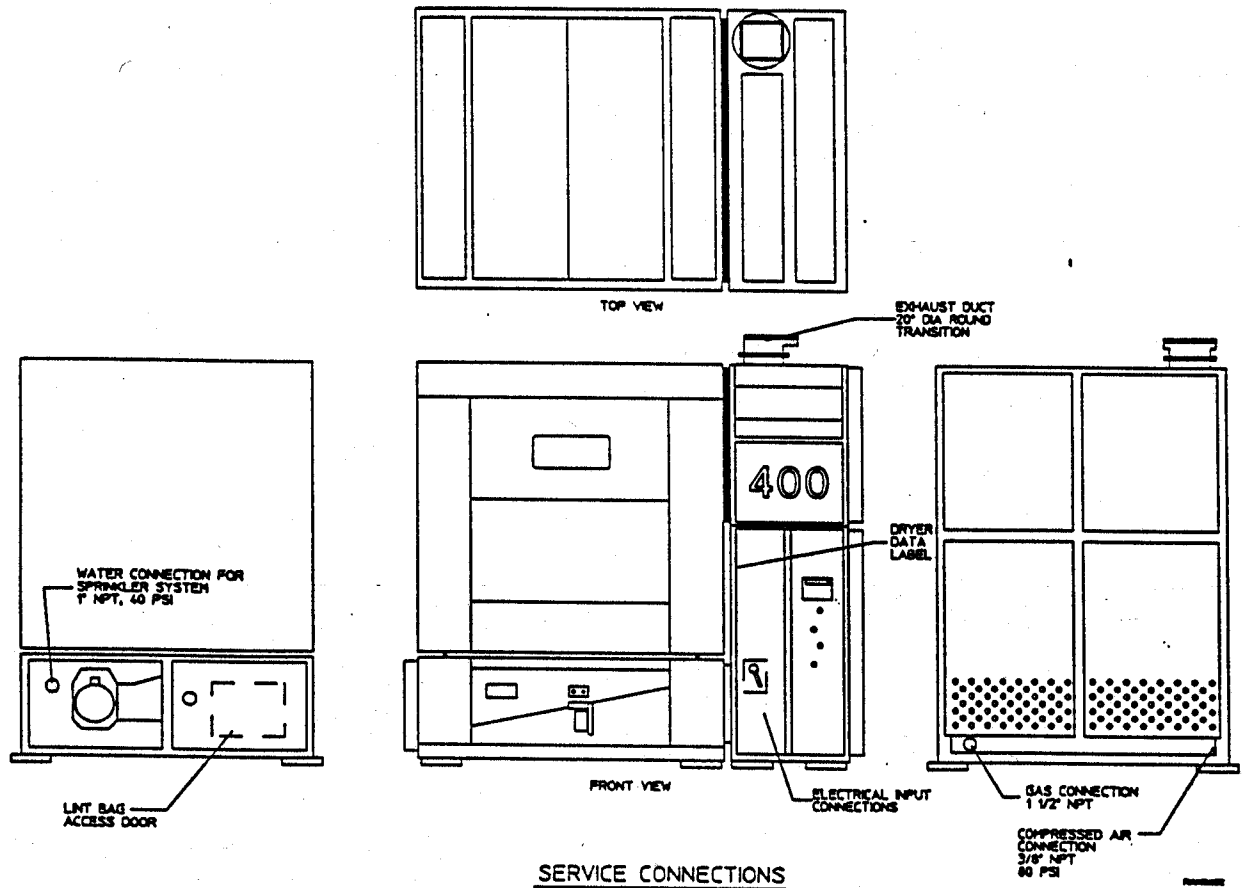

# ELECTRICAL PRE-INSTALLATION INFORMATION

INSTALLATION OF THE AD-400 DRYER SHOULD BE PERFORMED BY QUALIFIED AND TRAINED PROFESSIONALS IN ACCORDANCE WITH ALL APPLICABLE LOCAL AND STATE ELECTRIC CODES AND ORDINANCES. IN THE ABSENCE OF THESE CODES, INSTALLATION MUST CONFORM TO THE AMERICAN NATIONAL STANDARD: NATIONAL ELECTRICAL CODE ANSE/NFPA 70, LATEST EDITION.

**CAUTION:** Use only copper cable for electrical hook-up. Use of aluminum cable will void your warranty.

The AD-400 must be supplied with two independent power lines and protected by separate fused disconnects. One (3 phase) line will supply main dryer power, the other (single phase) will supply power to an independent sprinkler safety circuit.

The sprinkler safety circuit will power down the entire dryer should a fire be detected in its tumbler, and activate its water sprinkler.

**IMPORTANT :** Sprinkler power must be "ON" to engage the dryer's main disconnect switch. Repeated attempts to engage the disconnect switch without sprinkler power on will damage it.

- The AD-400's approximate load is 39 horsepower
- Fuse ratings specified are for dual-element, time delay, current limiting devices
- Circuit breakers specified should be thermal/magnetic and 3-pole for main power to the AD-400
- Dryer must be grounded for proper operation and safety
- All system wiring is rated at 105 degrees celsius
- The system's sprinkler circuitry draws approximately 500 VA.

# MAIN ELECTRICAL SERVICE CONNECTIONS

It is important that the electrical services to the AD-400 do not obstruct its operation. Therefore flexible conduit must be routed on the floor between the system's two main modules and connected to the lower portion of the main electrical enclosure. Use of appropriate conduit fittings is required to insure the system's NEMA-12 (water & dust resistant) rating. Fig. 2

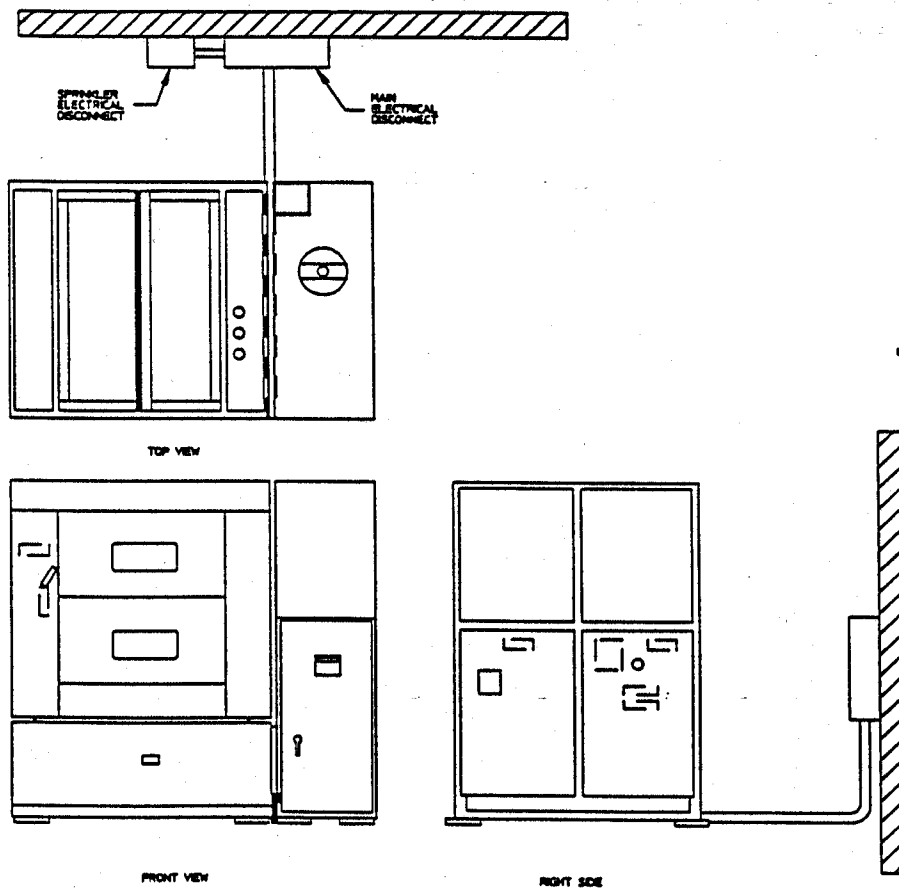

FIGURE 2

The following chart provides information to size the correct electrical service capacities and protections for the input power voltage rating selected.

AD-400 Gas/Steam Electrical Specifications -Main Electrical Connections							
Voltage	Phase	Wires	AWG	Current	Feed Capacity*	Fuses	Breakers
208	3	3,4	2	36 A	200 A	150 A	150 A
240	3	3,4	2	75 A	200 A	125 A	150 A
380	3	3,4	6	47 A	100 A	75 A	100 A
416	3	3,4	6	43 A	100 A	70 A	90 A
460	3	3,4	6	39 A	100 A	70 A	90 A

\* Recommended electric feed capacity includes the power needed for the sprinkler system.

AD-400 Gas/Steam Electrical Specifications -Sprinkler Circuit Electrical Connections*						
Voltage	Phase	Wires	AWG	Current	Fuses	Breaker
208	1	2	18	2.4 A	5 A	5 A
240	1	2	18	2.1 A	5 A	5 A
380	1	2	18	1.3 A	5 A	5 A
416	1	2	18	1.2 A	5 A	5 A
460	1	2	18	1.1 A	5 A	5 A

\* Sprinkler system power should be connected upstream of the main electrical service, protected by its own separate wall disconnect.

# ELECTRICAL INSTALLATION REQUIREMENTS

The dryer will arrive in a number of sections that will require both mechanical and electrical assembly. Once the system's mechanical requirements have been satisfied, see mechanical pre-installation section of this package, the following electrical connections must be performed.

- 1 . TUMBLER & BASE INPUT SIGNAL CONNECTIONS
- 2 . TUMBLER JUNCTION BOX CONNECTION (If Tumbler Shipped Separately)
- 3 . LINT FAN MOTOR
- 4 . LEFT & RIGHT TUMBLER MOTORS
- 5 . LINT SCREEN MOTOR
- 6 . PENDANT ARM INSTALLATION
- 7 . TUMBLER SENSORS INTERFACE CABLE



1. Locate two large plugs that connect the TUMBLER and BASE sections to the MAIN ELECTRICAL ENCLOSURE. Route these labeled cables through the base of the burner section, and latch them to their "KEYED" mating connectors. Fig. 3

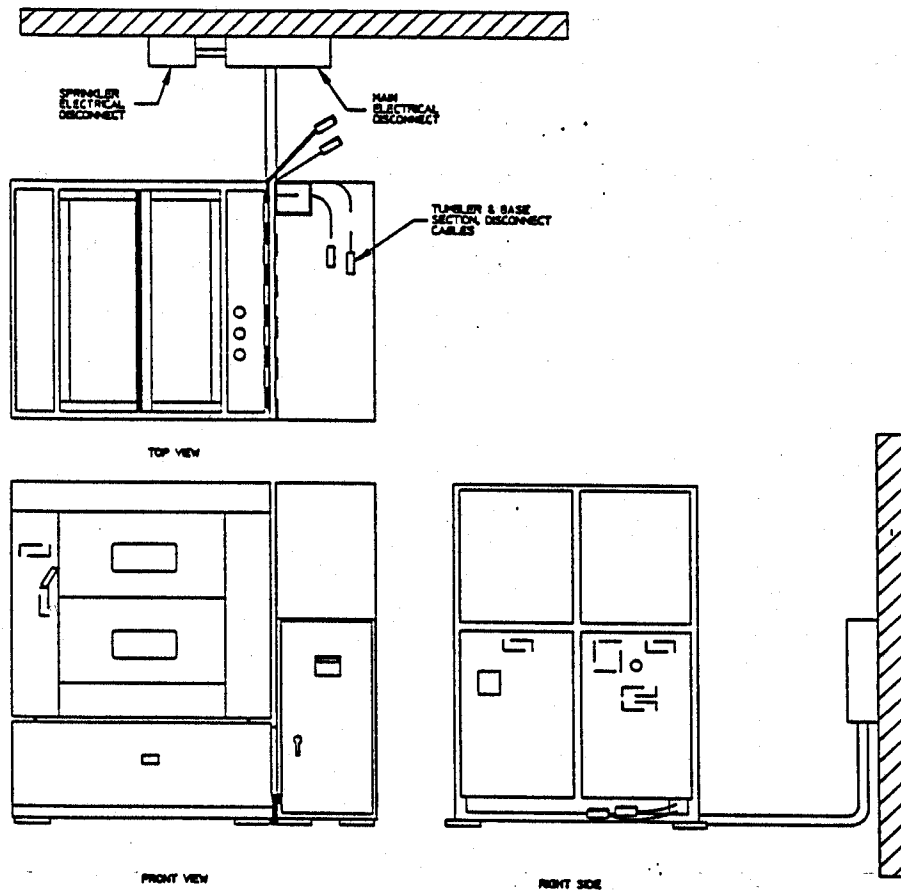

FIGURE 3

11000

2. If the TUMBLER section of the AD-400 was shipped separately, locate a labeled disconnect plug in the Lint Fan area of the dryer. Route this connector through the tumbler section of the machine, and connect it to the Tumbler Junction Box. Strain relief as noted. Fig. 4

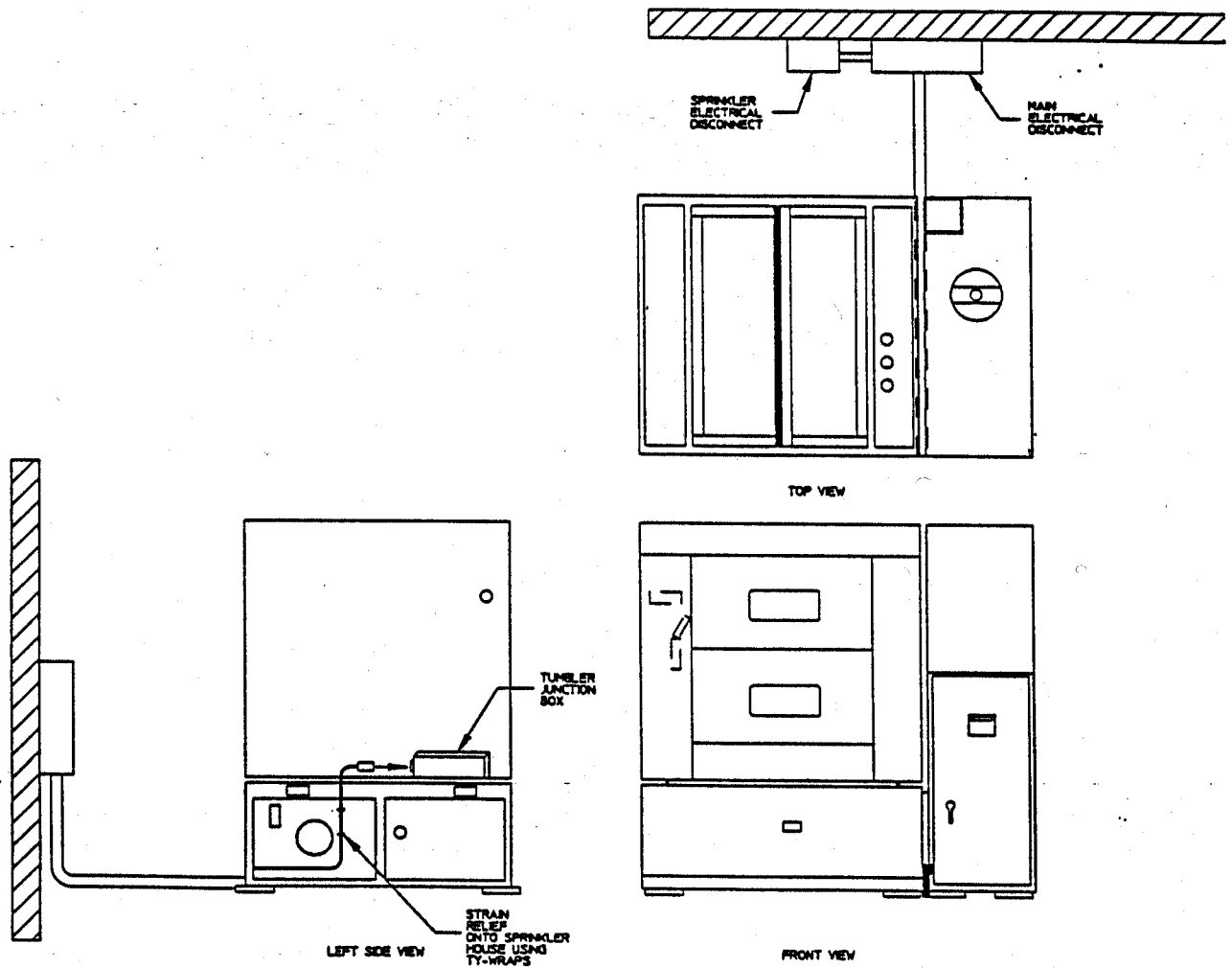

FIGURE 4

3/8/78

3. LINT FAN motor connection: Locate its labeled conduit in the AD-400's burner section, route cable to the LINT FAN'S electrical junction box and connect. Fig. 5

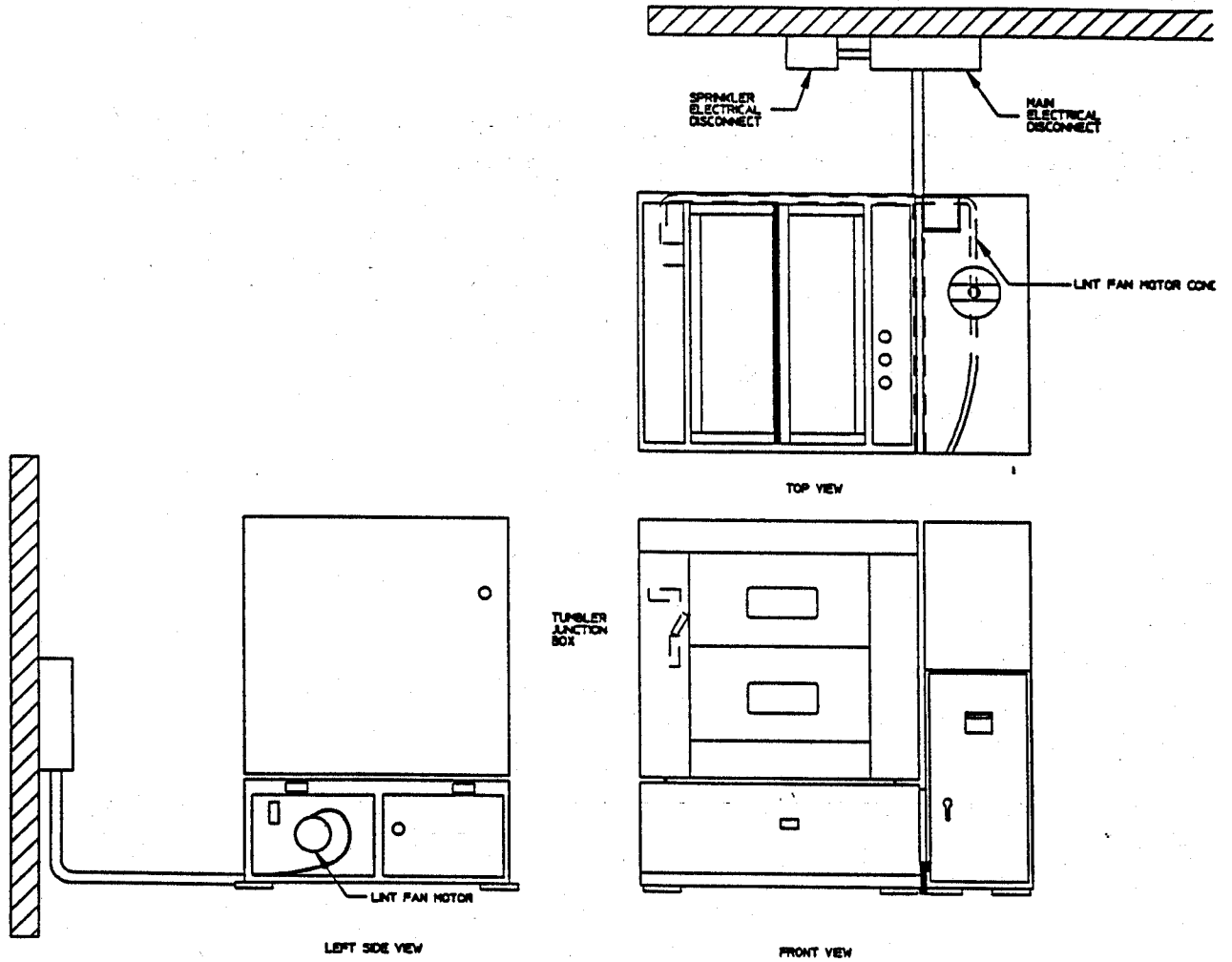
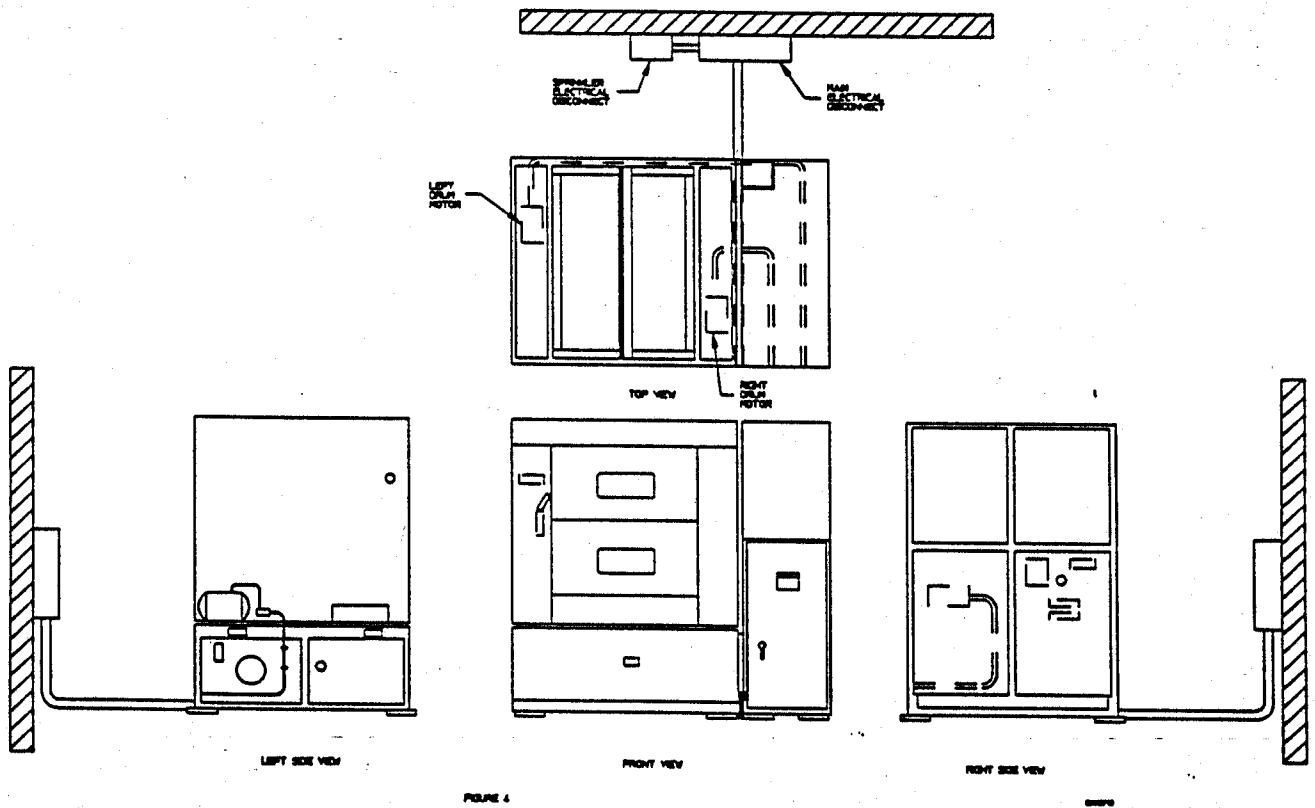

FIGURE 5

NAEP

4. TUMBLER drive motors connection: Locate their respective labeled conduit cables in the burner section of AD-400, and route to their junction boxes for connection. Strain relief as noted. Fig. 6



5. LINT SCREEN motor connection: Locate a labeled section of 3/8" conduit & wire in the Main Electrical Enclosure. Connect to the Lint Screen Motor's electrical junction box. Fig. 7

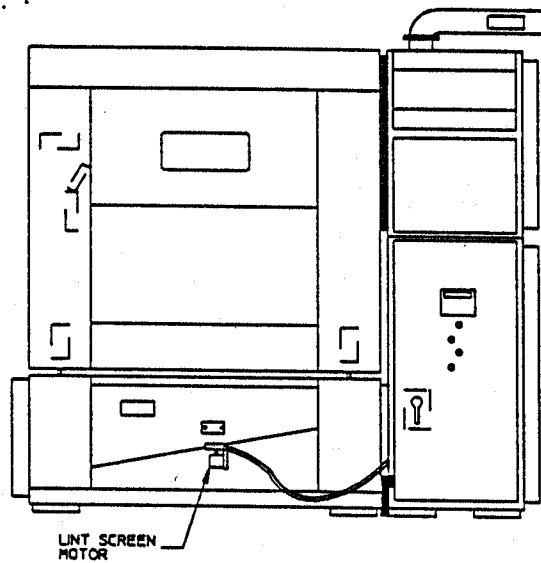

FRONT VIEW

FIG. 7

6. Locate the "PENDANT ARM ASSEMBLY" and carefully attach it to the top of the of the dryer's burner section. Connect cables to its associated junction box. One cable is for pendant control signals, the other for drying cycle status. Fig. 8

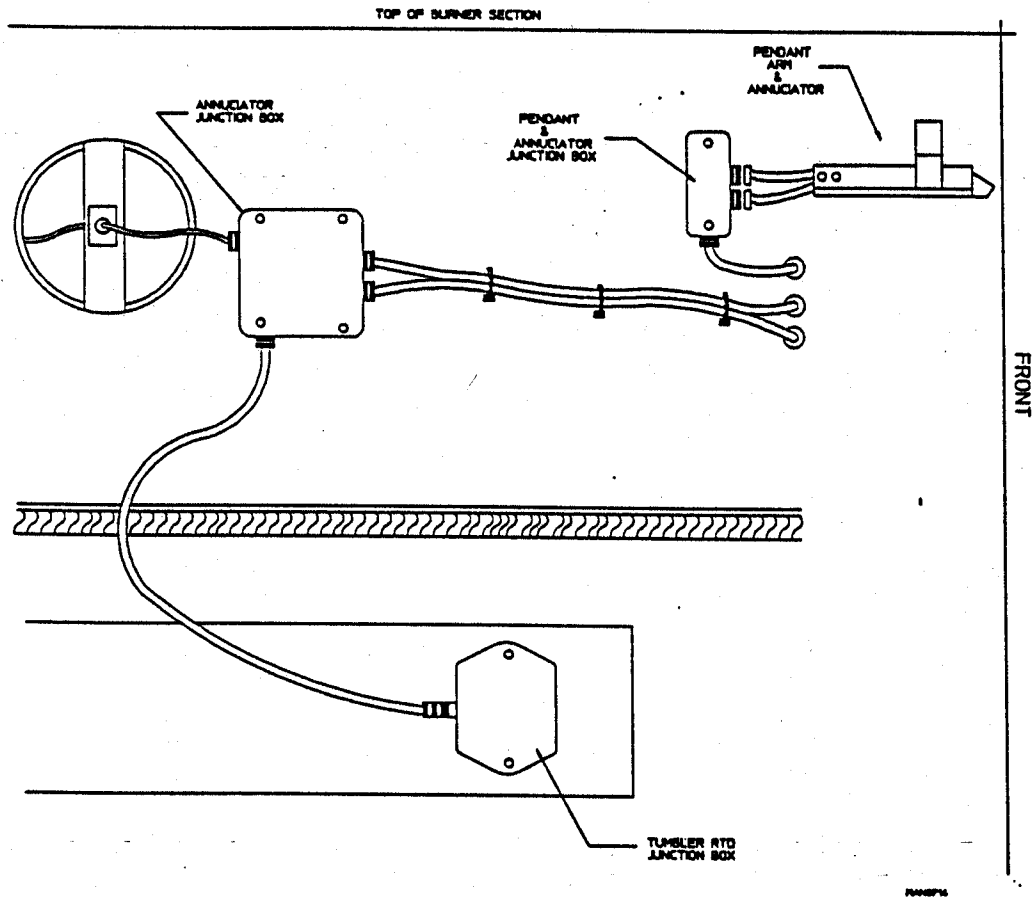

7. Locate the labeled "Tumbler Section Sensor Cable" atop the dryer and carefully re-connect to the "Tumbler Section Sensor Interface Box". Fig. 8

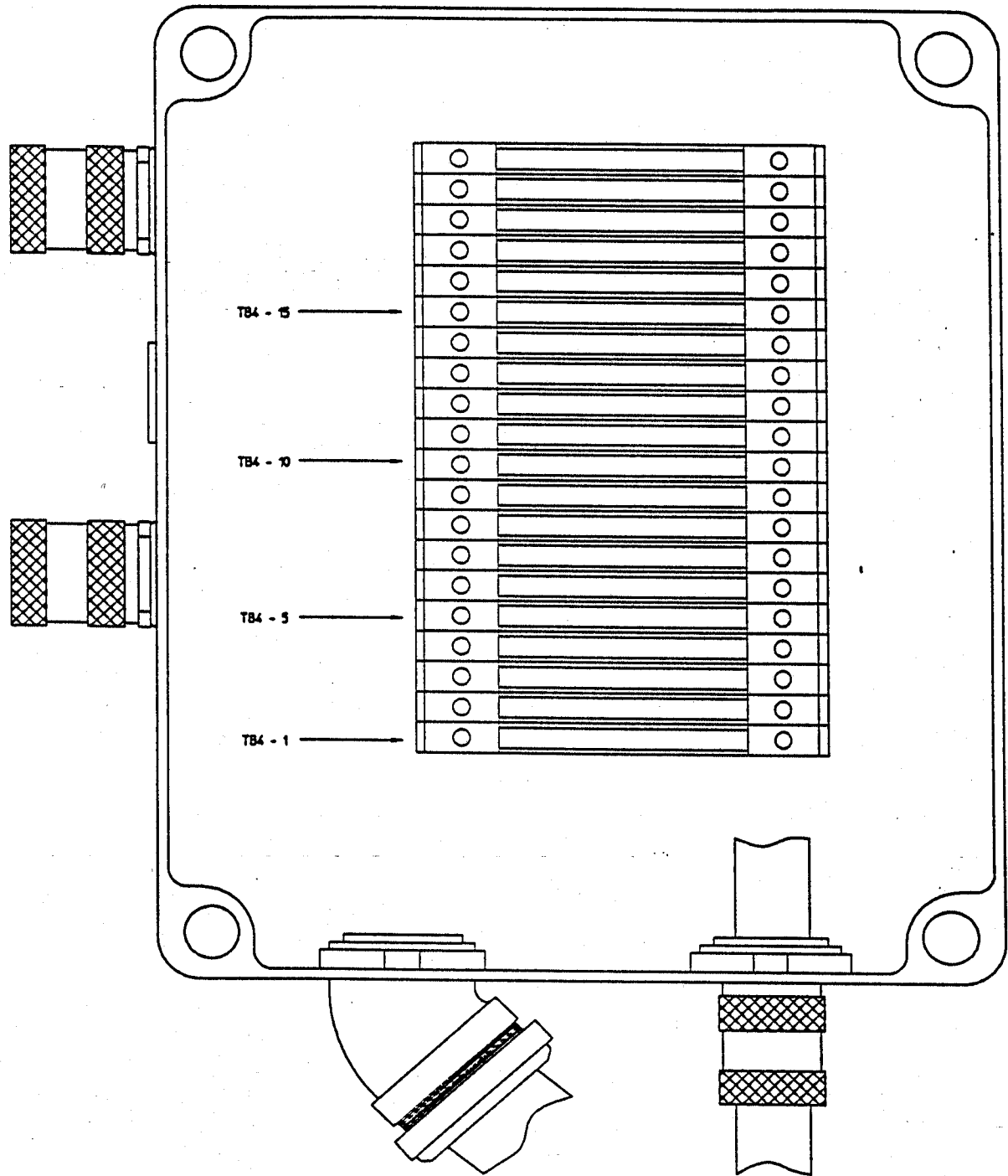

# MAIN ELECTRICAL CONNECTIONS

Main input power and sprinkler circuit connections are located at the lower left of the main electrical panel. Fig. 9

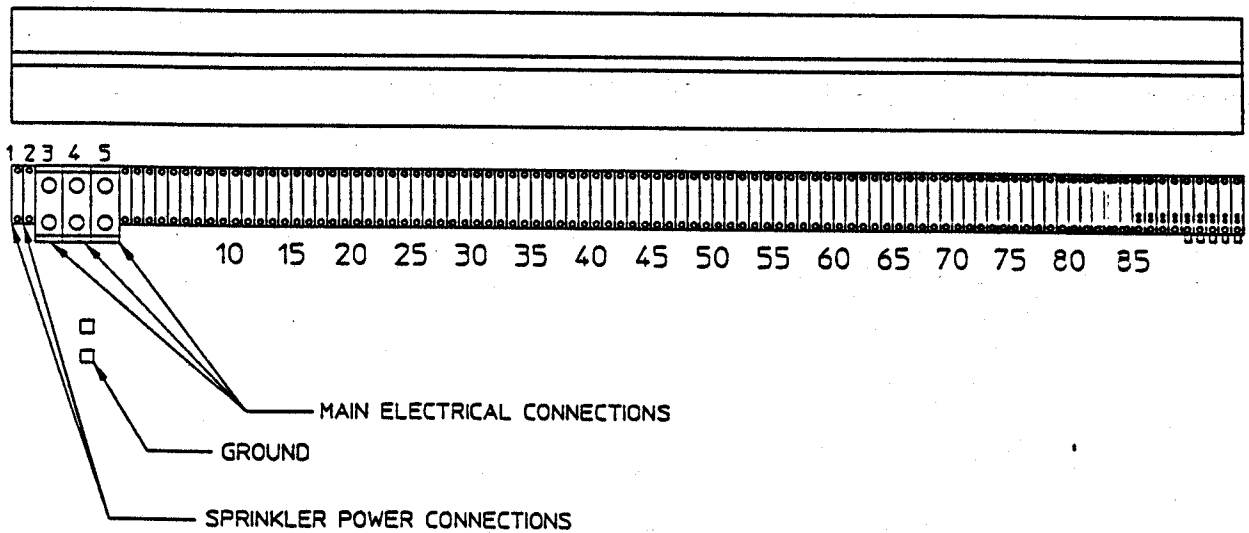

MAN0715

Sprinkler power is connected to TB1 - 1, 2, 3. Main electrical power is connected to TB1 - 4, 5, 6 & GROUND.



# PHASE ROTATION TEST

The following test will insure that the dryer's input power phases are connected correctly. With both power disconnects switched on, turn ON the MAIN disconnect located on the dryer's main control door.

Open the main control door, press MS-1 "Fan Motor" manual plunger for a second and verify that the Main Fan Motor is rotating in the direction of its arrow. If rotation is incorrect, turn off the main power to the dryer, including sprinkler power and swap lines on TB-1, 4 & 5 and re-test.

Refer to the AD-400's Service Manual for more detailed information.

Should you have any questions regarding the installation requirements of the AD-400, please contact us immediately at:

AMERICAN DRYER CORPORATION  
88 CURRANT RD., FALL RIVER, MA 02720-4781  
PHONE: (508)678-9000 FAX: (508) 678-9447 TELEX: 927520

PHONE INQUIRES: ASK FOR THE SERVICE DEPARTMENT, ON AD-400 PRE-INSTALLATION INFORMATION.