

Dexter WCAD18KCS-12 (T-300) Drain Valve

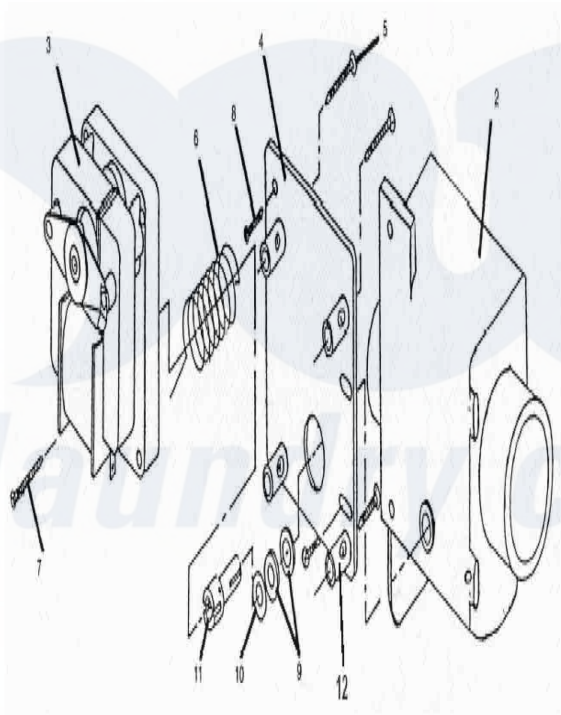

Dexter [Commercial Dexter WCAD18KCS-12 \(T-300\) Washer Parts](#) Parts Diagram Drain Valve
 Click on the part number to view part

Item	Original Part Number	Replaced By	Status	Part Description
--	9379-177-009			Valve, Drain (includes #2 thru #11)
2	9064-068-001			Body, Valve (w/ball)
3	9914-137-012		Not Available	Motor & Gear Train (complete)
4	9452-538-001			Plate, Motor Mtg
5	8639-994-001			Screw
6	9534-340-001			Spring, Drive
7	9545-054-001			Screw
8	9545-054-002		Not Available	Screw
9	9532-134-001			Seal, V Packer
10	8641-584-001			Washer
11	9451-196-001			Pin, Main Drive

12	9538-149-001		Plate (spacers needed for replacement motor mtg. plate)
13	9089-036-004	Not Available	Stator and Coil Assembly
--	9379-177-006	9379-177-009	Valve, Drain (includes #2 thru #11)
"	9914-137-001	9914-137-011	Motor & Gear Train (complete)

the laundry company[®]

the laundry company[®]

the laundry company[®]