

Dexter WCAD25KCS-12 (T-400) Door Lock

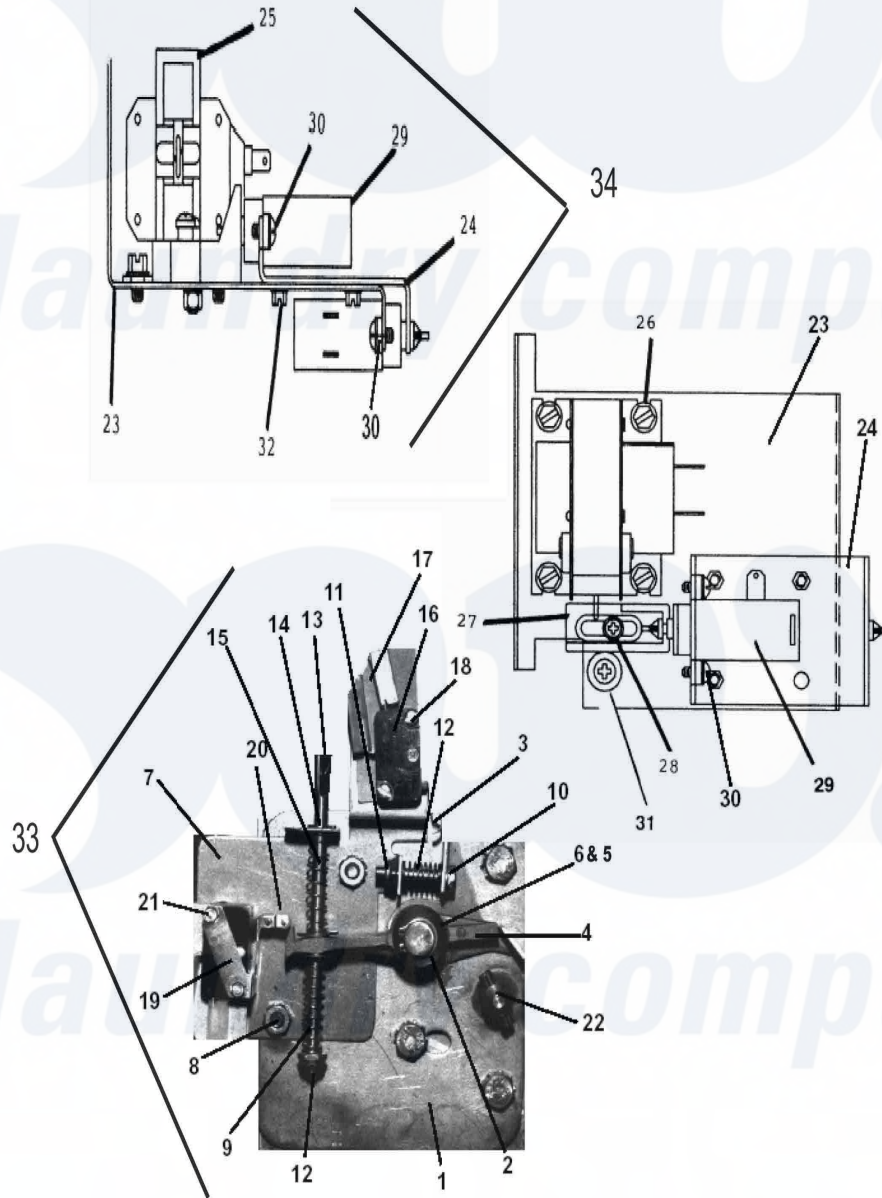

Dexter Commercial Dexter WCAD25KCS-12 (T-400) Washer Parts Parts Diagram Door Lock

Click on the part number to view part

Item	Original Part Number	Replaced By	Status	Part Description
33	9885-023-001	9885-024-001		Lock Assy, Complete (#1-22)(includes #1 thru #22)
1	9982-284-001			Plate Assy, Door Lock
2	8641-581-030			Washer, Flat
3	9008-005-001			Actuator, Latching Switch
4	9450-002-002			Pawl, Locking
5	8641-569-003			Washer, Spring
6	9487-200-004			Ring, Retaining
7	9029-035-001		Not Available	Bracket, Switch
8	8640-413-002			Nut, Hinge to Door
9	9534-364-002			Spring, Actuating
10	9545-012-020			Screw, Hx. 10-32 x 1 0

11	8640-413-004		Nut, Elastic Stop
12	9534-364-001		Spring, Return
13	9451-193-001		Pin, Guide
14	9487-200-005		Ring, Retaining
15	8641-581-031		Washer
16	9539-461-008		Switch, Latching Sensing
17	9550-169-003		Shield, Switch
18	9545-020-001		Screw, Switch Mtg
"	8640-401-001		Nut, Special Twin
19	9539-461-007		Switch-Micro
20	9008-006-002		Actuator, Switch
21	9545-020-003		Screw 4-40 x 1 1/8"
"	8640-401-001		Nut, Special Twin
22	9451-181-004		Pin, Dowel
--	9552-037-001		Shim, Door Lock, Thin
"	9545-018-004	Not Available	Screw, Lock mtg 1/4" x 20 x 3/4"
"	8641-582-007		Lockwasher 1/4"
34	9922-011-001	9922-011-001P	Solenoid Assy.
23	9029-073-001		Bracket, (Door Locking Solenoid)
24	9985-169-001		Bracket Assy, Solenoid Slide
25	9536-074-001		Solenoid 120V 60 hz
26	9545-008-001		Screw 10-32 x 1/4"
27	9540-033-002	9540-036-001	Stop, Door Lock Solenoid
28	9545-061-001		Screw, Shoulder
"	8640-411-002		NUT-ELASTICSTOP,#6-32
29	9586-001-001		Thermoactuator 120 V
30	9545-031-011		Screw #6 x 5/16"
31	9538-157-004		Spacer, Plastic
"	9538-166-004		Spacer, Metal
"	9545-010-001		Screw, Cross Recessed
"	8640-412-005		NUT-HEXKEPS,#8-32
--	8640-412-005		NUT-HEXKEPS,#8-32
"	9497-225-006		Rod, Pull