

## Dexter WCVD18KCS-12 Drain Valve Group 18LB

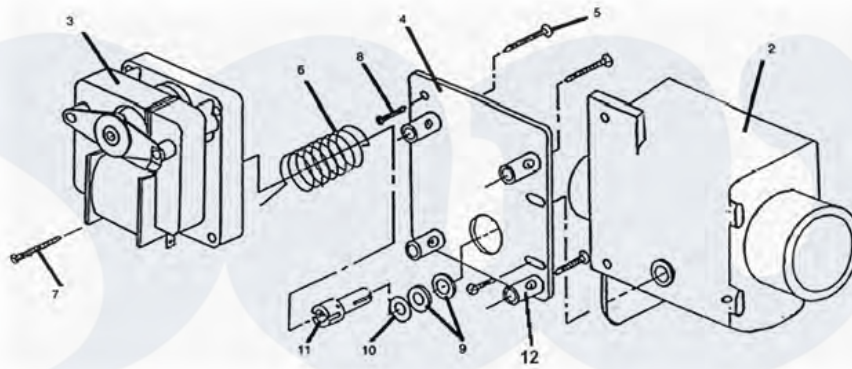

Dexter Commercial [Dexter WCVD18KCS-12 Washer Parts](#) Parts Diagram Drain Valve Group 18LB  
 Click on the part number to view part

101

Item	Original Part Number	Replaced By	Status	Part Description
*	9379-177-006	<a href="#">9379-177-009</a>		Valve, Drain (includes #2 thru #11)
2	<a href="#">9064-068-001</a>			Body, Valve (w/ball)
3	9914-137-001	<a href="#">9914-137-011</a>		Motor & Gear Train (complete)
4	<a href="#">9452-538-001</a>			Plate, Motor Mtg
5	<a href="#">8639-994-001</a>			Screw
6	<a href="#">9534-340-001</a>			Spring, Drive
7	<a href="#">9545-054-001</a>			Screw
8	9545-054-002		Not Available	Screw
9	<a href="#">9532-134-001</a>			Seal, V Packer
10	<a href="#">8641-584-001</a>			Washer
11	<a href="#">9451-196-001</a>			Pin, Main Drive

***the laundry company***<sup>®</sup>

***the laundry company***<sup>®</sup>

***the laundry company***<sup>®</sup>