

Maytag A18CM 04 - MAYTAG COIN SLIDE (A18CM)

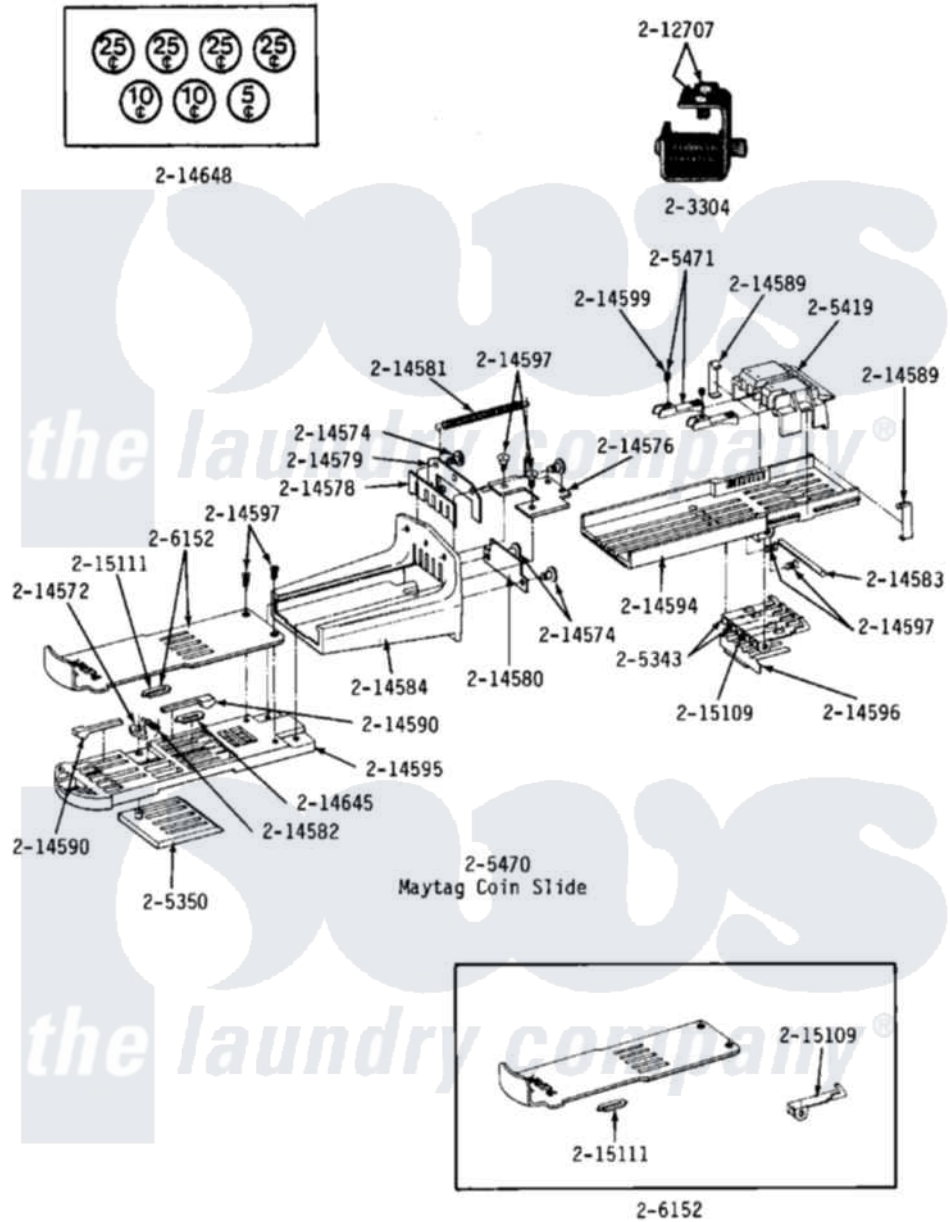

Maytag Commercial Maytag A18CM Washer Parts Parts Diagram 04 - MAYTAG COIN SLIDE (A18CM)
 Click on the part number to view part

Item	Original Part Number	Replaced By	Status	Part Description
001	NLA		Not Available	ACTUATOR KIT-WASHER SLIDES--N
002	205343		Not Available	LOWER GAGE ARM ASSEMBLY
003	205350			Stop Block Assembly
004	NLA		Not Available	MEASURING BLOCK ASSEMBLY
005	NLA		Not Available	MAYTAG COIN SLIDE
006	NLA		Not Available	MOVABLE COIN GAGE
007	NLA		Not Available	SLIDE PLATE W/NICKEL INSERT
008	212707	3196385		Screw
009	214572		Not Available	ARM, RATCHET
010	NLA		Not Available	STUD FOR COIN SLIDE
011	NLA		Not Available	END BRACKET FOR SLIDE
012	214578			Gate For Coin Opening
013	NLA		Not Available	RETAINER FOR GATE
014	NLA		Not Available	RETAINER FOR GAGE

014	NLA	Not Available	SPRING
015	214581		Spring, Return
016	214582		Spring For Ratchet Arm
017	NLA	Not Available	PIN FOR LOWER GAGE ARM
018	214584	Not Available	HOUSING FOR COIN SLIDE
019	214589		Clip, Spring
020	NLA	Not Available	PLUG FOR COIN OPENING
021	214594	Not Available	BASE INSERT FOR HOUSING
022	NLA	Not Available	SLIDE BODY
023	214596		Spring For Lower Gage Arm
024	214597		Screw
025	NLA	Not Available	SET SCREW FOR GAGE
026	NLA	Not Available	DIME INSERT
027	214648		Decal, Coinage
028	NLA	Not Available	LOWER GAGE ARM
029	NLA	Not Available	NICKEL INSERT

