

Maytag A18CM 09 - CLUTCH, BRAKE & BELTS

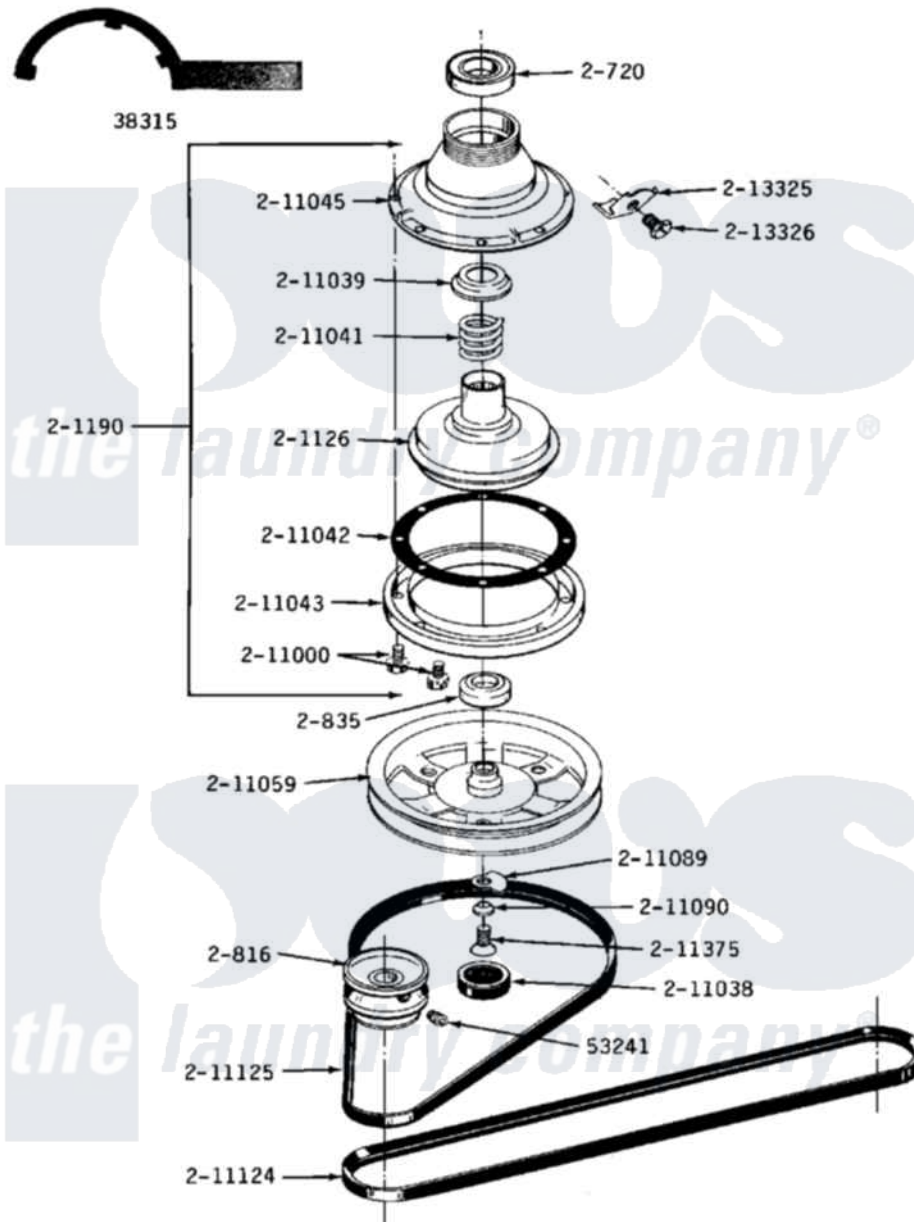

Maytag Commercial Maytag A18CM Washer Parts Parts Diagram 09 - CLUTCH, BRAKE & BELTS
 Click on the part number to view part

Item	Original Part Number	Replaced By	Status	Part Description
001	Y038315	038315		Tool
002	Y053241			Set Screw, Motor Pulley
003	Y200720	22003441		Bearing, Rear
004	200816	6-2008160		Pulley- MO
005	200835			Bearing, Brake Rotor
006	201126	6-2011900		Brake Asse
007	201190	6-2011900		Brake Asse
008	211000			SCREW, BRAKE DRUM (HEX HEAD)
009	NLA		Not Available	CAP, OIL RETAINER
010	211039	6-2011900		Brake Asse
011	211041	6-2011900		Brake Asse
012	211041	6-2011900		Brake Asse
013	211042	6-2011900		Brake Asse
014	211043	6-2011900		Brake Asse
015	211045	6-2011900		Brake Asse
016	211059	6-2301530		Pulley

017	211089		Lug, Stop Pulley
018	211090	22003555	Washer, Stop Lug
019	211124		Part Not Used
020	211125		V Belt, Drive Pulley
021	211375	681582	Screw
022	213325		Clip, Retaining
023	213326		Bolt, Sems Retaining Clip

