

Maytag AT35MN2 05 - COIN METER & COIN BOX

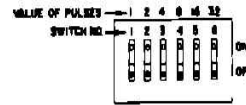

DETAIL A
COIN COUNTER
DIP SWITCHES

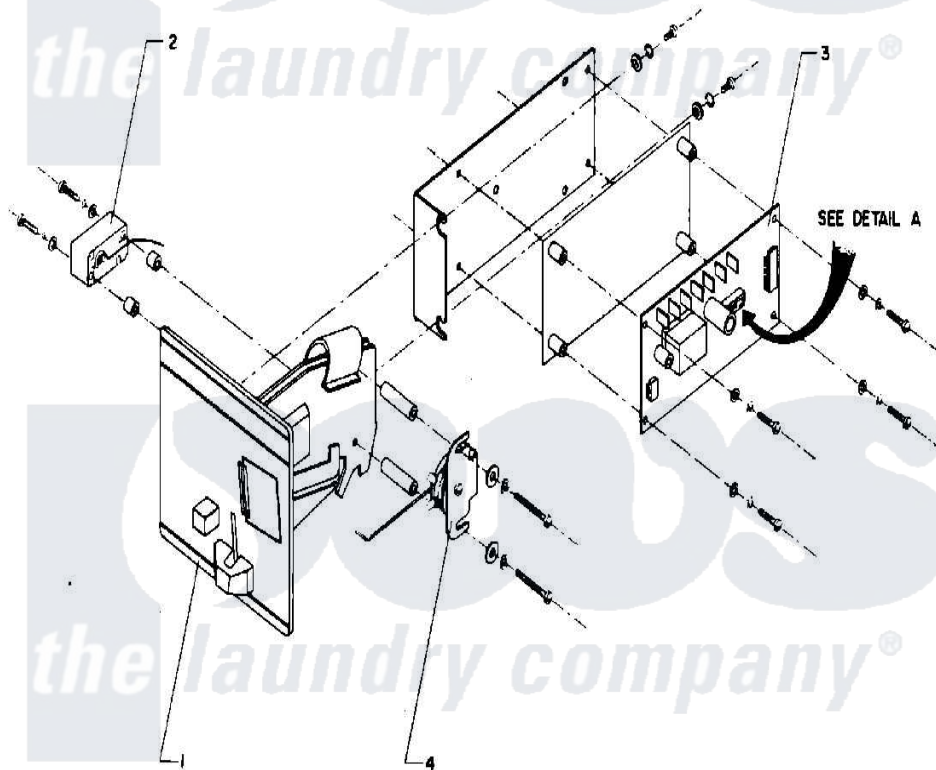

Maytag [Commercial Maytag AT35MN2 Washer Parts](#) Parts Diagram 05 - COIN METER & COIN BOX
Click on the part number to view part

Item	Original Part Number	Replaced By	Status	Part Description
001	24001615			COIN ACCEPTOR (US QUARTER)
"	24001754		Not Available	COIN METER (110V/50-60HZ) (US QUARTERS)
"	24001755		Not Available	COIN METER (110V/50-60HZ) (CANADIAN QUARTERS)
"	NLA		Not Available	COIN METER, HANKE (DIGITAL)
002	NLA		Not Available	COIN SWITCH
003	24001617		Not Available	ELECTRONIC COIN COUNTER W/HAR
004	24001618		Not Available	SOLENOID, COIN BLOCKING (120V)
"	24001756			Solenoid, Coin Blocking