

# Maytag MAF35PN2 01 - MAIN EXPLODED VIEW - COMPUTER MODELS

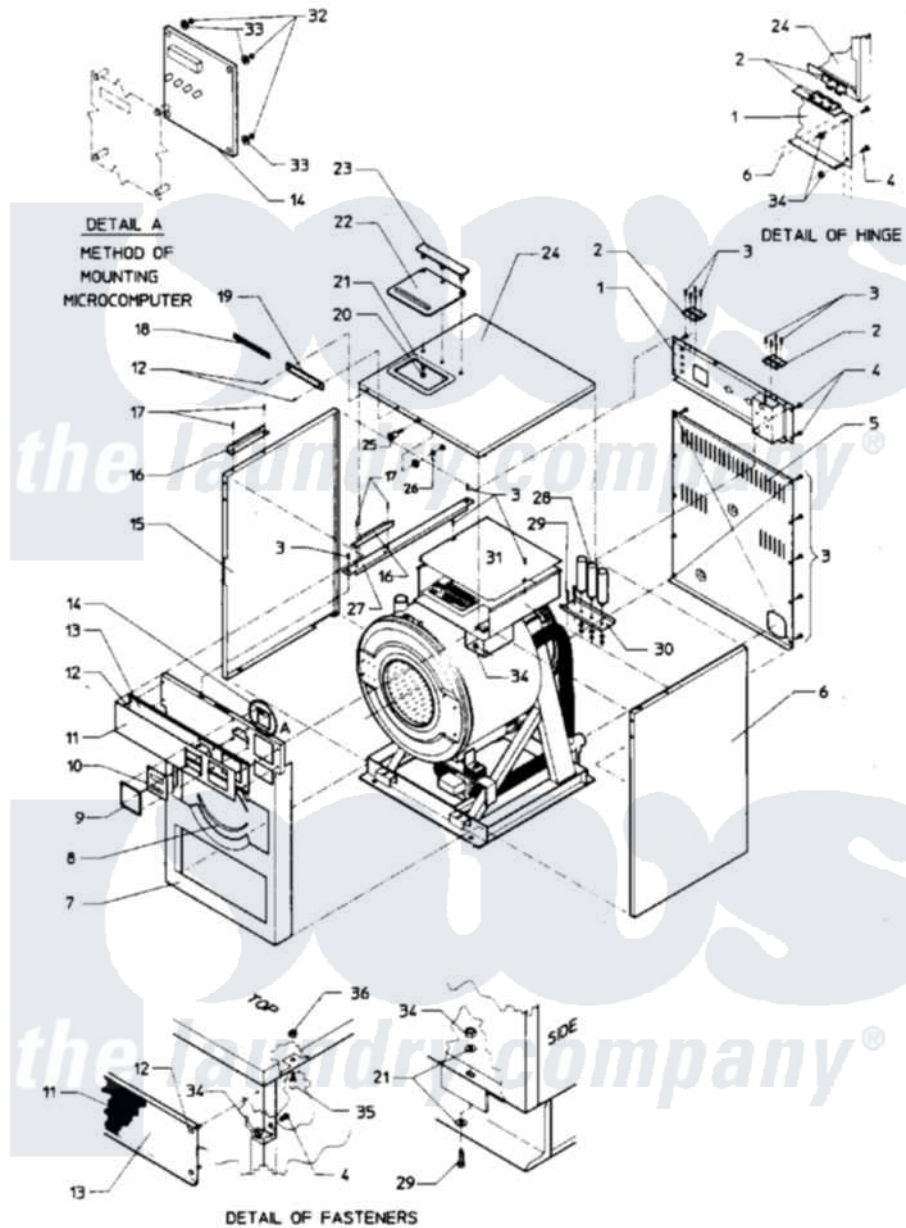

Maytag [Commercial Maytag MAF35PN2 Washer Parts](#) Parts Diagram 01 - MAIN EXPLODED VIEW - COMPUTER MODELS

[Click on the part number to view part](#)

Item	Original Part Number	Replaced By	Status	Part Description
001	24001170		Not Available	PANEL KIT, VALVE
002	24001676		Not Available	HINGE, TOP COVER (NOTE: 18003069 AFTER SERIAL
"	<a href="#">Y24001300</a>			Hinge
003	24001301	<a href="#">67006964</a>		Screw, Glide
004	<a href="#">24001323</a>			Screw
005	24001403		Not Available	KIT, PANEL (REAR)
006	24001159		Not Available	PANEL KIT, SIDE (RT.) <sup>35</sup> (AS VIEWED FROM FRONT)
007	24001702		Not Available	PANEL, FRONT (INR)
008	24001550	<a href="#">24001532</a>		Trim- Pane
009	NLA		Not Available	TRIM, KEYPAD (CPTR GREY)
010	<a href="#">24001112</a>			Switch, Membrane
"	24001114		Not Available	SWITCH, MEMBRANE (PC)
011	NLA		Not Available	DECAL
012	<a href="#">24001533</a>			Rivet, Pop S.s.

013	NLA		Not Available	PANEL, CONTROL
014	<a href="#">24001010</a>			Board, Coin Computer
"	<a href="#">24001709</a>			Board, Computer
015	24001157		Not Available	PANEL KIT, SIDE (LT.)35
016	24001539		Not Available	BRACKET, SOAP DISPENSER
017	24001540		Not Available	RIVET, BLIND S.S. (1/8 X 5/16)
018	NLA		Not Available	DECAL (MAYTAG)
019	24001671		Not Available	NAMEPLATE
020	24001510	<a href="#">W1013975Z</a>		Nut
021	<a href="#">24001295</a>			Lockwasher, S.s.
022	24001219		Not Available	COVER, SOAP DISPENSER
023	<a href="#">24001542</a>			Clamp, Soap Dispenser
024	NLA		Not Available	COVER KIT, TOP
025	<a href="#">24001220</a>			Lock, Top Cover
026	<a href="#">24001221</a>			Latch, Top Cover
027	24001690		Not Available	BRACE, TOP
028	<a href="#">24001237</a>			Capacitor
"	<a href="#">24001238</a>			Capacitor
"	<a href="#">24001239</a>			Capacitor
"	<a href="#">24001240</a>			Capacitor
"	<a href="#">24001241</a>			Capacitor W/Res.
"	<a href="#">24001242</a>			Capacitor
029	<a href="#">24001303</a>			Screw
030	24001674		Not Available	BRACKET, CAPACITOR
031	24001545		Not Available	COVER, ELECTRICAL MODULE
032	24001417	<a href="#">7103P070-60</a>		Nut, Top Pilot
033	<a href="#">24001415</a>			Washer, S.s.
034	<a href="#">24001305</a>			Nut, Fiberlock
035	24001546		Not Available	STUD, S.S. (6/32" X 1/4")
036	<a href="#">24001425</a>			Nut, Fiberlock, Pltd
"	24001675		Not Available	RESISTOR (12K OHMS 5 WATT) (W/CENTURY OR ELMO MOTORS)

