

Maytag MAT26PCABG 04 - TUB COVER

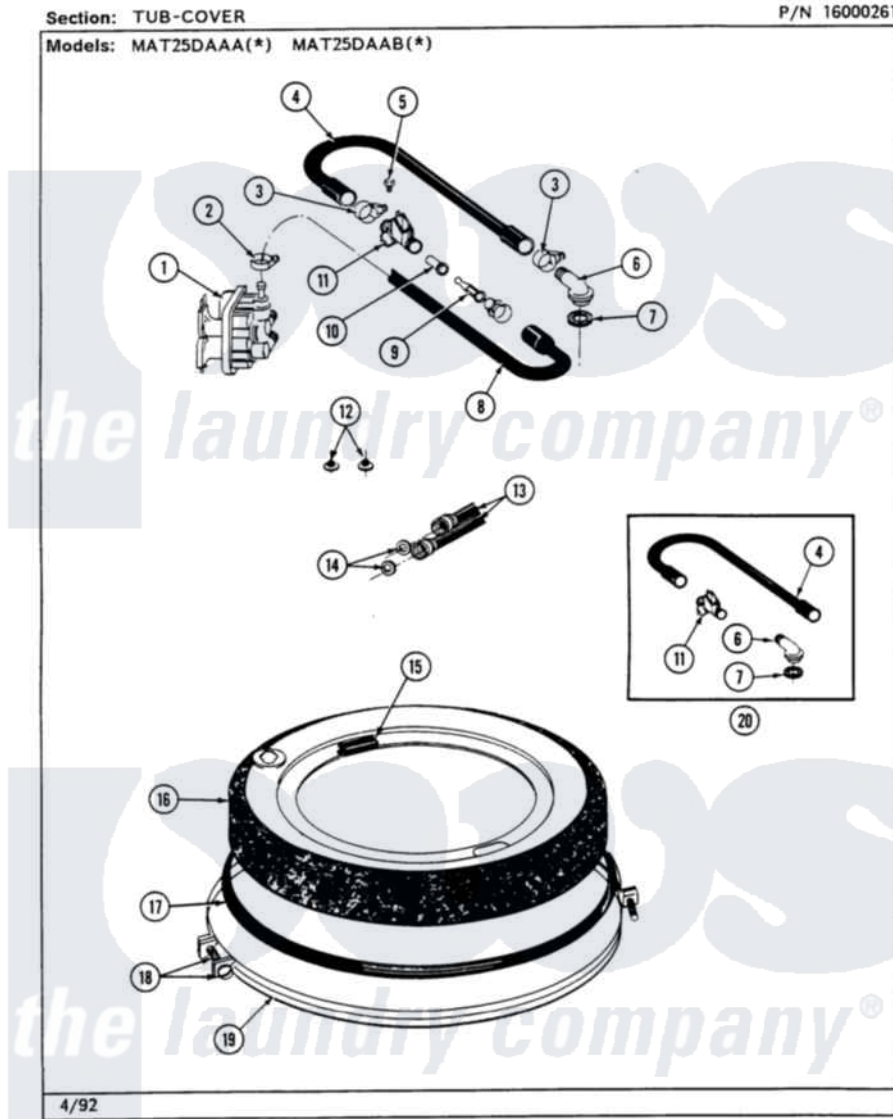

10

Maytag [Commercial Maytag MAT26PCABG Washer Parts](#) Parts Diagram 04 - TUB COVER
 Click on the part number to view part

Item	Original Part Number	Replaced By	Status	Part Description
001	205614	205613		Water Valve
002	201575			Clamp, Hose
003	202515	596669		Clamp, Manifold
004	Y215234			Hose, Injector Fill
005	312620			Screw, Sems
006	215235			Tube, Injector
007	215233			Seal For Injector Tube
008	213013			Hose, Injector
009	213015			Nozzle, Injector
010	213016	216201		Nozzle
011	215447			Sleeve For Injector
012	200961	12001413		Strainer And Washer Kit
013	205828	202860		Inlet Hose Assembly
014	Y013783			Washer, Inlet Hose
015	215232			Bumper, Unbalance
016	206380		Not Available	COVER, TUB

017

[211232](#)

Seal, Tub Cover

018

[205529](#)

Nut And Bolt Kit For Tub Clam

019

[200846](#)

Clamp - Tub Cover

020

206683

[206680](#)

Water Injector Assembly

