

Whirlpool CAM2762KQ0 05 - REAR PANEL

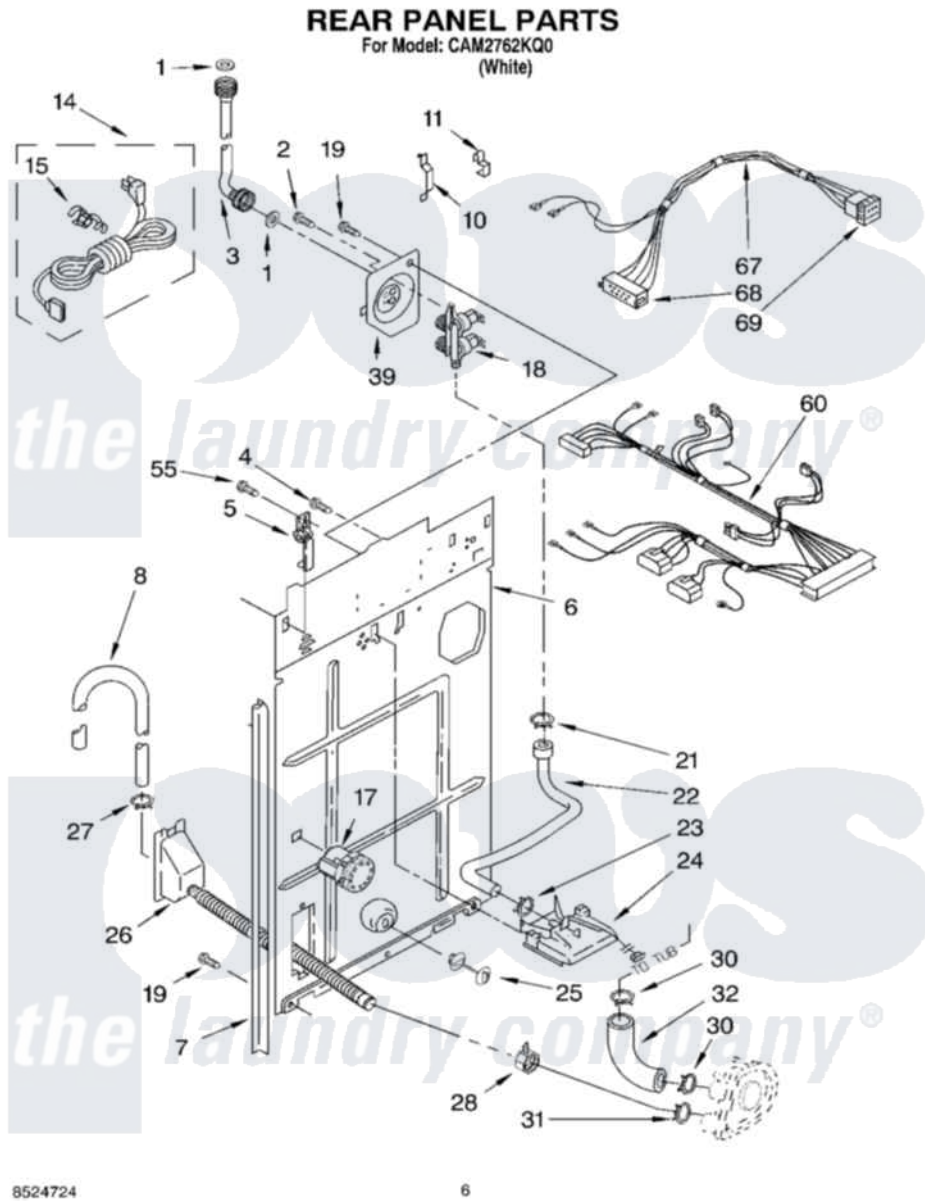

Whirlpool [Commercial Whirlpool CAM2762KQ0 Washer Parts](#) Parts Diagram 05 - REAR PANEL
Click on the part number to view part

Item	Original Part Number	Replaced By	Status	Part Description
1	16123			Washer Inlet-Hose Miscellaneous Parts Must be Ordered Separately.
2	9740848			Screw, Mixing Valve Mounting
3	3949380			Hose, Water Inlet
"	3949381			Hose, Water Inlet
4	3351614			Screw, Gearcase Cover Mounting
5	387402			Hinge
6	8312721	285929		Panel-Rear
7	3354204	62747		Pad, Rear Panel
8	96743			Hose, Drain
"	661577	285666		Hose
"	3357090	285702		Hose
10	8054658			Clip, Harness
11	8282518			Clip, Harness
14	3359548	285928		Cord-Power

15	63848	285777	Relief-Str
17	3952720	W10339019	Switch-WL
18	3952164	285805	Valve-Inlet
19	62863	3390631	Screw, 10-16 X 3/8
21	370451	596669	Clamp, Manifold
22	62662	3357328	Hose, Vacuum Break
23	371503	596669	Clamp, Manifold
24	3347034		Break, Vacuum
25	8519200		Support, Rear Panel
26	8317940	W10358149	Drain Hose Assembly
27	3366912	356138	Clamp, Hose
28	3976395		Restraint, Hose
30	3363366	616099	Clamp
31	8317496	285655	Clamp, Hose
32	3951449	285871	Hose
39	3347682	285930	Plate
55	3390647	488729	Screw
60	3955505		Harness, Wiring
67	3355803		Harness, Timer
68	352089		Timer, Block Disconnect
69	96895		Cap, Terminal

