

Whirlpool CAM2762RQ0 04 - REAR PANEL PARTS

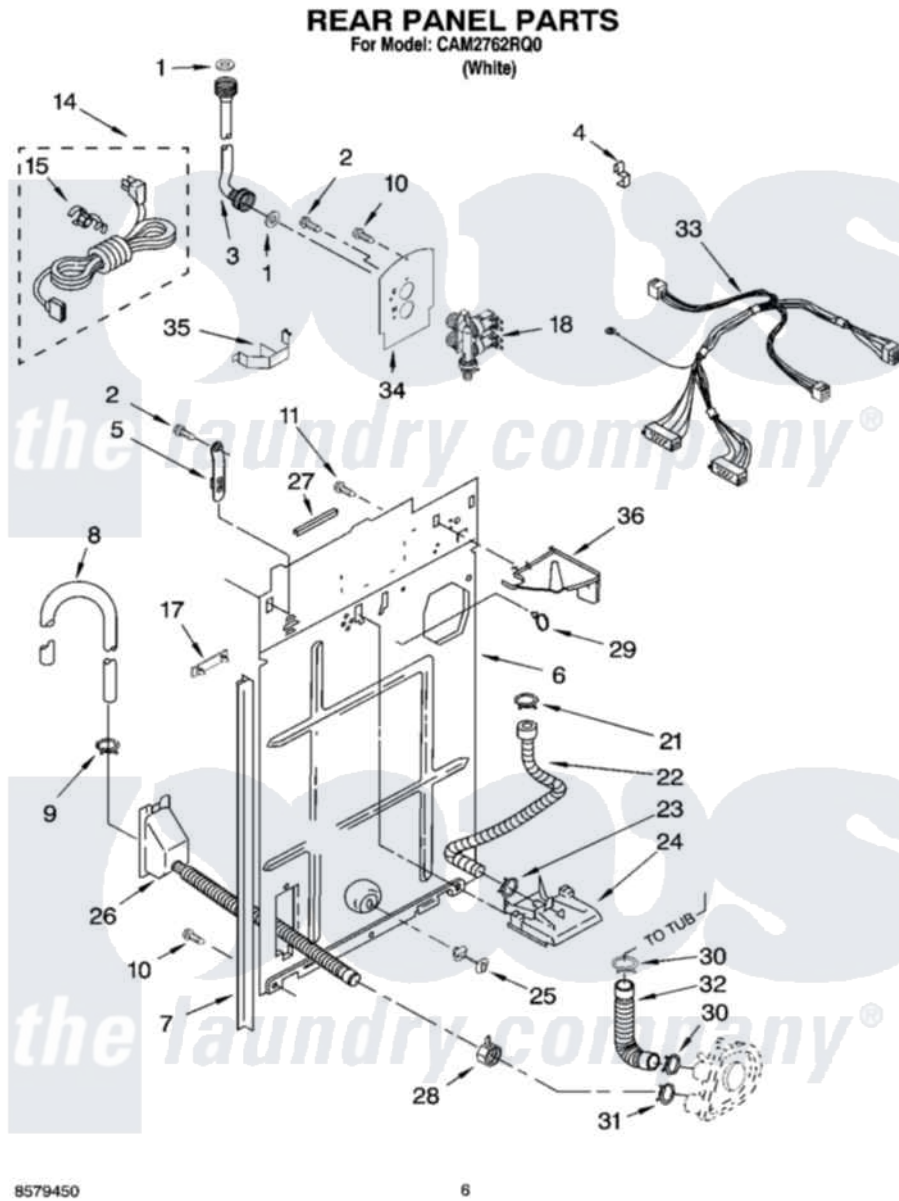

Whirlpool [Commercial Whirlpool CAM2762RQ0 Washer Parts](#) Parts Diagram 04 - REAR PANEL PARTS
Click on the part number to view part

Item	Original Part Number	Replaced By	Status	Part Description
1	3976300	16123		Washer Inlet-Hose Miscellaneous Parts Must be Ordered Separately.
2	9740848			Screw, Mixing Valve Mounting
3	3949380			Hose, Water Inlet
"	3949381			Hose, Water Inlet
4	8282518			Clip, Harness
5	8568314			Strap, Console
6	8541649	285929		Panel-Rear
7	3354204	62747		Pad, Rear Panel
8	96743			Hose, Drain
"	661577	285666		Hose
"	3357090	285702		Hose
9	371507	371502		Clamp, Hose
10	62863	3390631		Screw, 10-16 X 3/8
11	3351614			Screw, Gearcase Cover Mounting

14	3359548	285928	Cord-Power
15	3952821	285777	Relief-Str
17	389379		Retainer, Side To Feature Panel
18	3979347	3979346	Valve, Water Inlet And Thermistor Assembly
21	301958	596669	Clamp, Manifold
22	8317974	8317926	Hose, Vacuum Break
23	370450	596669	Clamp, Manifold
24	387606	3360977	Break-Vac
25	8519200		Support, Rear Panel
26	8317940	W10358149	Drain Hose Assembly
27	303294	3367669	Protector, Edge
28	3976395		Restraint, Hose
29	8559320		Restraint, Hose
30	3363366	616099	Clamp
31	3366912	356138	Clamp, Hose
32	3951449	285871	Hose
33	3957379		Harness, Timer
34	8541624	285930	Plate
35	8055003		Clip, Harness And Pressure Switch
36	8539874		Shield, Suds
"	BLANK	Not Available	Following Parts Not Illustrated
"	3954579		Miscellaneous Parts Bag

