

Whirlpool GCGM2991TQ1 02 - CABINET PARTS

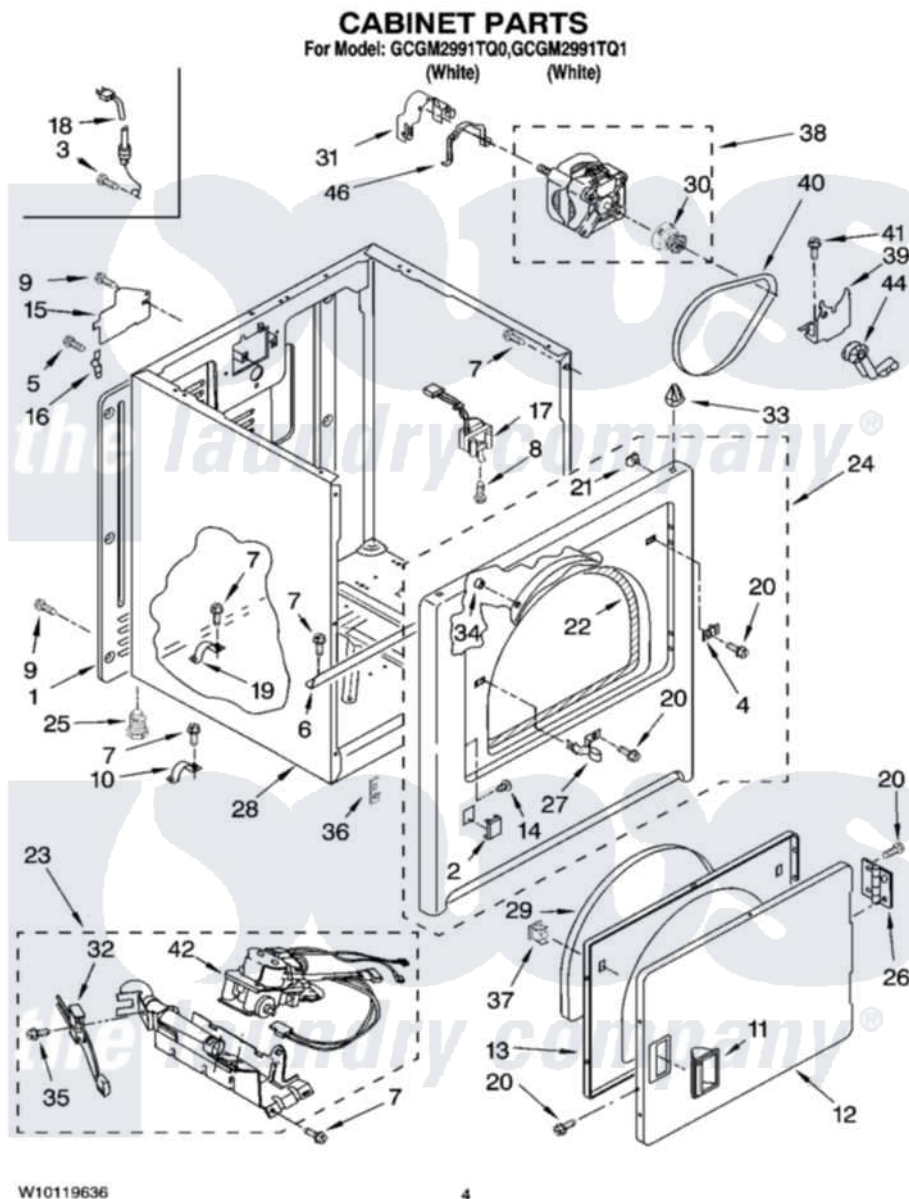

Whirlpool Commercial Whirlpool GCGM2991TQ1 Dryer Parts Parts Diagram 02 - CABINET PARTS
Click on the part number to view part

Item	Original Part Number	Replaced By	Status	Part Description
1	3396805	280043		Panel-Rear
2	3394975			Plug, Front Panel
3	697776	4331106		Screw, No.10-32 X 7/16
4	3403630			Plug, Strike Hole
5	388326			Screw, 8-18 X 1.25
6	8541400			Bracket, Cabinet
7	343641	681414		Screw, 10AB X 1/2
8	697773	3395530		Screw
9	693995			Screw, Hex Head
10	3980175			Clamp, Elbow
11	3405184			Handle, Door
12	3402335			Door, Front
13	3402341			Door, Inner
14	3404413			Plug, Hinge Hole
15	3396795			Cover, Terminal Block
16	238088	8066217		Hinge, Top

17	3406109	3406107	Door Switch Assembly
18	3401401	3401402	Cord, Power
19	341029		Clamp, Pipe Door Spring
20	342055	488627	Screw
21	98234		Clip, U-Bend
22	3406129		Seal And Bearing Assembly
23	3401771	W10492502	Burner-Gas
24	W10224855	W10248059	Panel
25	3392100	49621	Feet-Leveling
"	279810		Foot-Optional
26	3405514	W10362431	Hinge And Pin Assembly
27	3403431		Strike, Panel
28	8530603	8533643	Cabinet
29	3405246		Seal, Door Push-To-Start
30	8066184		Pulley, Motor
31	3404162		Clamp, Motor
32	686590	279311	Ignitor
33	690363	18776	Lock, Front Top
34	685203	279220	Clip
35	3393909		Screw, 8-32 X 7/8
36	3394083		Clip, Front Panel
37	3389441		Door Catch Assembly
38	8066206	279827	Motor-Drve
39	348780		Base, Motor
40	W10131364	341241	Belt
41	3400500		Bolt, 3405245 5/16-18 X 3/4
42	8281908	279923	NAT Gas
44	691366		Idler And Pulley Assembly
46	W10121316		Plug, Multivent

