

Amana AA4111 15 - POWER CORD & WIRE TERMINALS

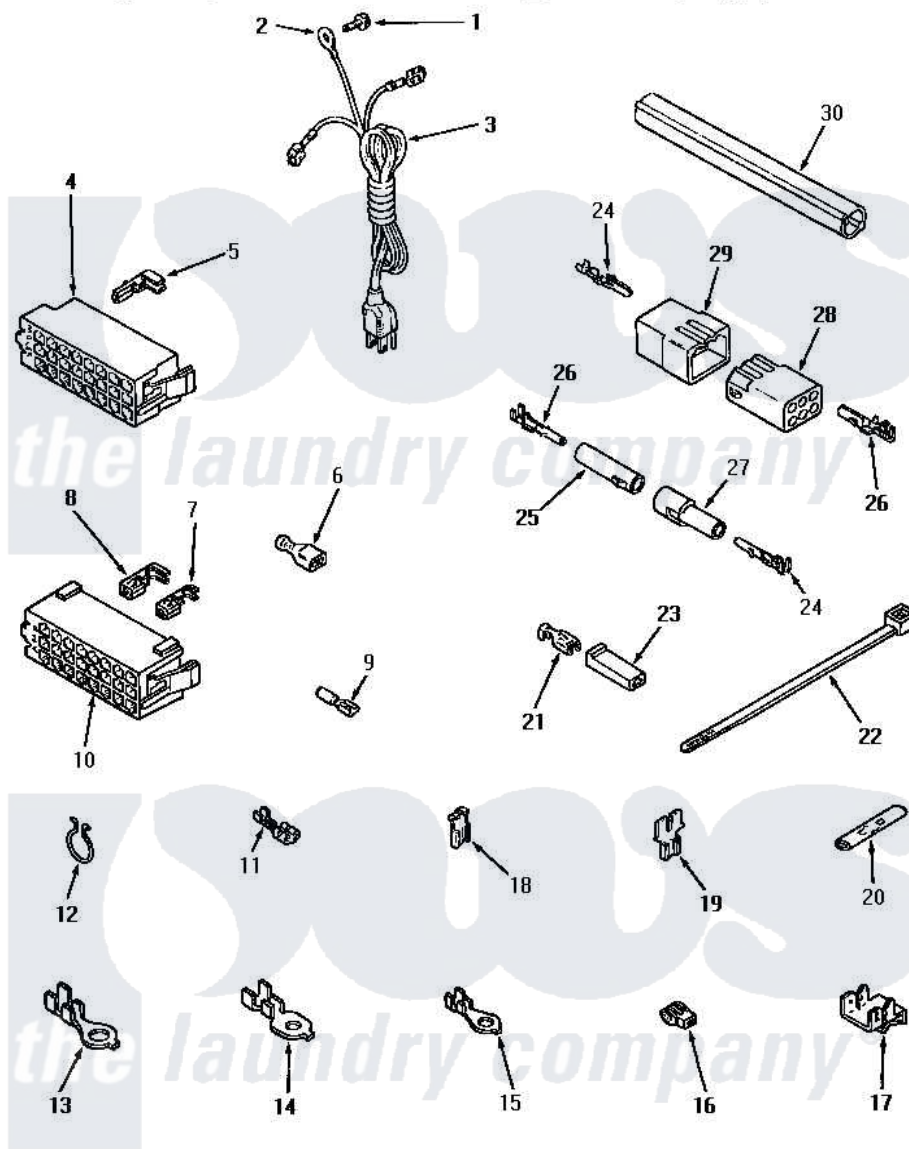

POWER CORD AND WIRE TERMINALS

Amana [Residential Amana AA4111 Washer Parts](#) Parts Diagram 15 - POWER CORD & WIRE TERMINALS
 Click on the part number to view part

Item	Original Part Number	Replaced By	Status	Part Description
1	52909			Screw, 10B-16 X 1/2 HeX
2	Y00000000		Not Available	SEE NOTE GOUND WIRE -- (GREEN)
3	22660		Not Available	POWER CORD AND PLUG
4	34123			Housing, LH -24 Position
"	32746			Housing, RH-24 Positi
5	Y00188			Molex Terminal
6	Y00163	285432		Terminal
"	Y00165			Insulated Spade Terminal
7	00180		Not Available	TERMINAL,FEMALE
8	00183		Not Available	TERMINAL,FEMALE 2-WIRE
9	Y00215			Barrel Insulated Spade
"	Y00214		Not Available	BARREL INSULATED SPADE(18 GAUG (1/4 INCH-18 GAUGE WIRE)
10	28856		Not Available	HOUSING,24 POSITION
11	Y00119		Not Available	SPADE TERMINAL(18 GAUGE) (1/4 INCH-(1) 18

			GAUGE WIRE)
"	Y00121	Not Available	SPADE TERMINAL(12 GAUGE) (1/4 INCH-(2) 18 GAUGE WIRES O
12	51291		Clip, Wire
13	Y00113	Not Available	TERMINAL,RING-1/4 STUD
14	Y00111		Ring Terminal No.10 No.10 18 Gauge Wires Or
15	00110		No.10 18 Gauge Wire
16	70210	Not Available	INSULATOR,BLUE
17	Y00161	B5733302	Clip, Ground
18	Y00120		Terminal, Flag-1/4 Fema
19	29673	Not Available	DOUBLE CONNECTOR
20	21091	Not Available	CONNECTOR TWO 1/4 INCH MALE
21	Y00115		Lock In Spade Terminal (18 Gaug (1/4 Inch-(1) 18 Gauge Wire)
22	55881	M0321209	Tie-Electrical
23	90789		Connector
24	Y00116		Terminal, Pin-Male
25	26301		Receptacle, Molex
26	Y00117	5011-XX	093 Female Socket
27	26302	Not Available	PLUG,1 CIRCUIT
28	26708		Receptacle, 6 Circuit
29	23041		Plug, 6 Circuit
30	33087	Not Available	ENCLOSURE,WIRE HARNESS

the laundry company[®]

the laundry company[®]