

Amana AA8431 04 - BRG HSG/BRAKE/PULLEY & PIVOT DOME

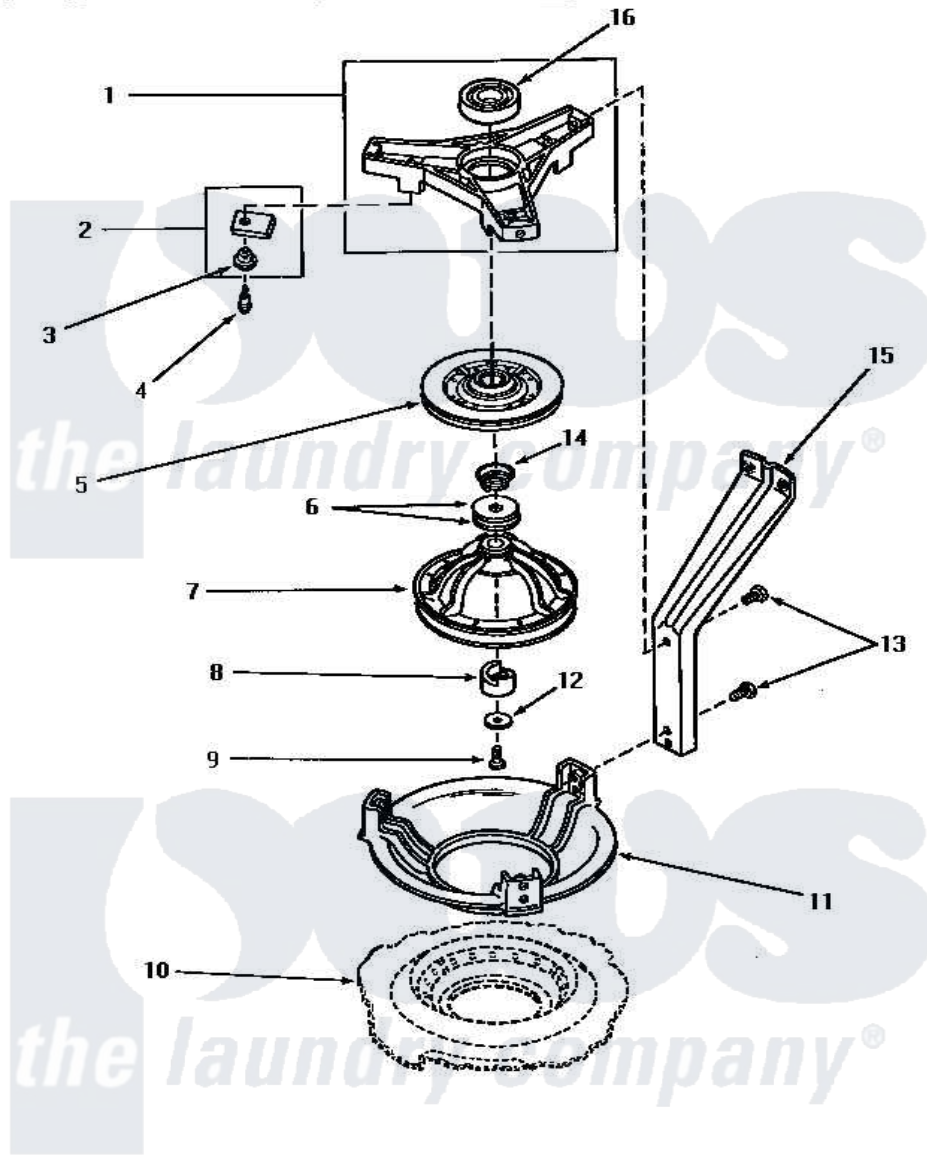

BEARING HOUSING, BRAKE, PULLEY AND PIVOT DOME

Amana [Residential Amana AA8431 Washer Parts](#) Parts Diagram 04 - BRG HSG/BRAKE/PULLEY & PIVOT DOME
 Click on the part number to view part

Item	Original Part Number	Replaced By	Status	Part Description
1	28913	35746		AssemLy, Bearing Housing-L
2	348P3	R9900543		Pad-Brake
3	29993			Sleeve, Anti-Rotation
4	26547			Screw, 10-24 Shoulder
5	31961	R9900474		Brake Assembly
6	32651	40065701		Washer, 2 Odx.63 ID
7	30260	34232P		Kit-Pulley
8	27018			Helix
9	27220	40063401		Screw, 1/4-20 x 5/8 Hex
10	Y00000000		Not Available	SEE NOTE BASE ASSEMBLY
11	27124		Not Available	DOME,PIVOT
12	26509	40041501		Washer
13	30016	40128701		Screw, 5/16-18 X .50
14	33435			Spring, Conical
15	27090			Leg, Support
16	28944R	40004001		Bearing, Main

