

**Amana AEM427W2 01 - BULKHEAD/FELT SEAL/CYL ROLLER & TERM BLK**

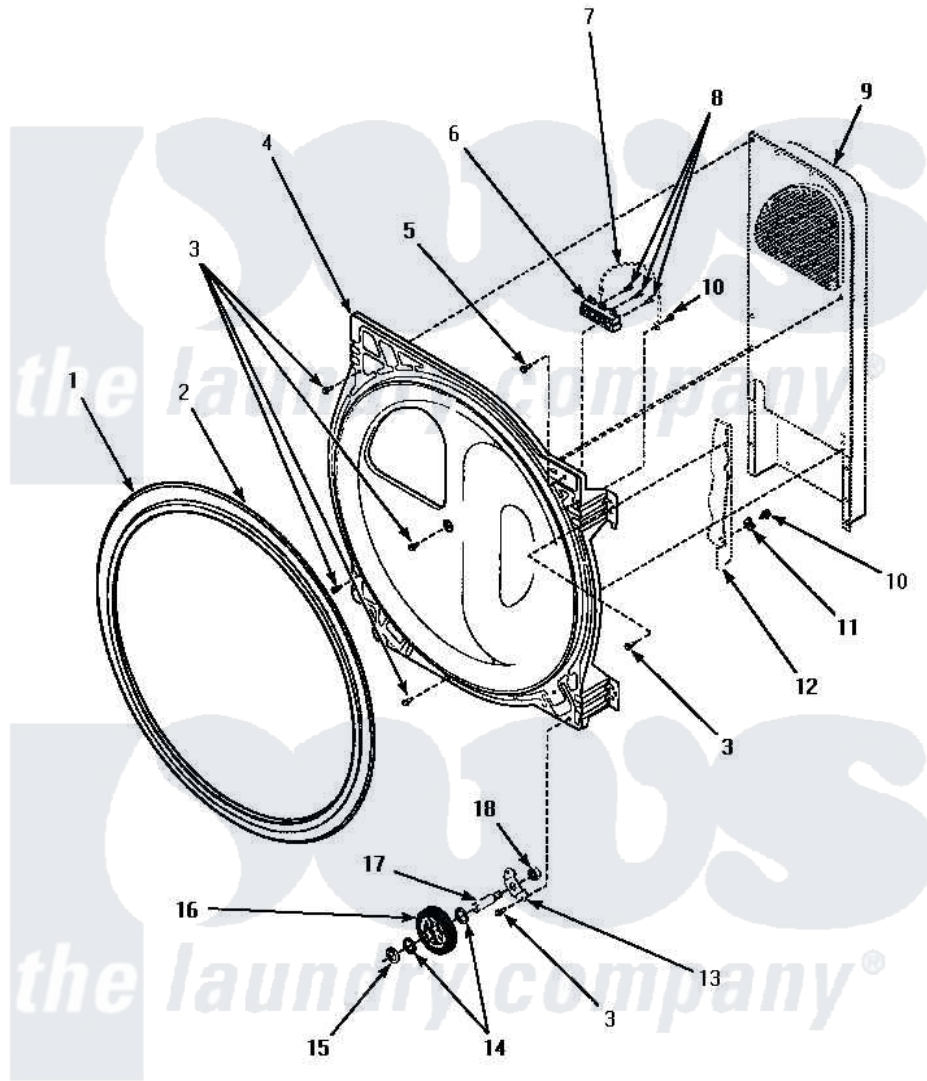

**REAR BULKHEAD, FELT SEAL, CYLINDER ROLLER AND TERMINAL BLOCK**

Amana [Residential Amana AEM427W2 Dryer Parts](#) Parts Diagram 01 - BULKHEAD/FELT SEAL/CYL ROLLER & TERM BLK

[Click on the part number to view part](#)

Item	Original Part Number	Replaced By	Status	Part Description
1	501801	<a href="#">37001132</a>		Seal, Cylinder
2	22506P	<a href="#">511637P</a>		Adh Dow 737 Clr 3 Oz Tube
3	501668	<a href="#">503688</a>		Screw, 10B-16 X .34 I
4	500356W	<a href="#">502614WP</a>		Bulkhead, Rear
5	<a href="#">501285</a>			Screw, No.12 X 9/16-Pla
6	61923P	<a href="#">61923</a>		Block, Terminal
7	Y00000000		Not Available	SEE NOTE GROUND WIRE, GREEN -- (SEE NOTE)
8	Y61199	<a href="#">3400094</a>		Screw, 10-32 X 3/8
9	Y00000000		Not Available	SEE NOTE HEATER BOX ASSEMBLY -- (SEE HEATER BOX ASSEMBLY PAGE)
10	<a href="#">20530</a>			Screw, 10-24 x 3/8 Hex
11	51474		Not Available	WASHER, 13/64IDX1/2ODX.
12	Y00000000		Not Available	SEE NOTE CABINET -- (SEE CABINET, EXHAUST DUCT AND BASE PAGE)

13	500062	<a href="#">40113601</a>	Assembly, Roller Brkt
14	<a href="#">52549</a>		Washer, 501 ID X3/4 Odx
15	<a href="#">23748</a>		Ring, Retaining
16	500214P	<a href="#">37001042</a>	Assembly, Cylinder Roller
17	<a href="#">56461</a>		Shaft
18	56156	<a href="#">358160</a>	Nut

