

Amana AEM497W2 (BOM: PAEM497W2) 04 - GAS VALVE, IGNITER & GAS CONVERSION KITS

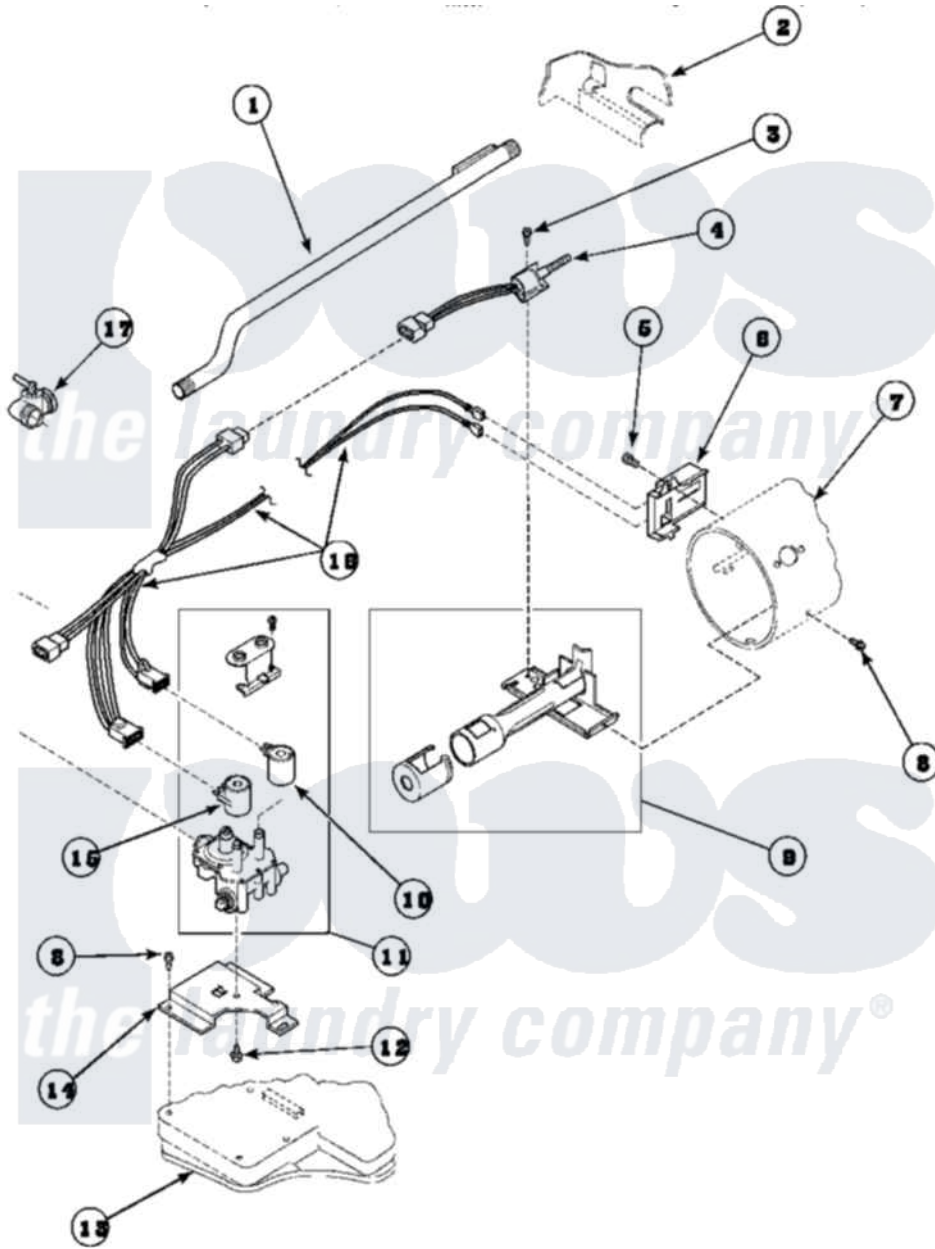

Amana Residential Amana AEM497W2 (BOM: PAEM497W2) Dryer Parts Parts Diagram 04 - GAS VALVE, IGNITER & GAS CONVERSION KITS
 Click on the part number to view part

Item	Original Part Number	Replaced By	Status	Part Description
1	500647	510204		Pipe
2	500001P		Not Available	(ADD LETTER BEFORE "P" IN PART
3	51782		Not Available	SCREW, 6B-20X5/16
4	60868	37001308		Ignitor
5	23222	3177991		Screw
6	Y56231	338906		Radiant, Sensor
7	61974		Not Available	BURNER HOUSING
8	501668	503688		Screw, 10B-16 X .34 I
9	Y56234	37001304		Burner Ign
10	58804B	694540		Coil, 60 Hz
11	58804			Assembly, Valve-Gas-Single-
12	56124	3370225		Screw
13	500070			Base, Dryer
14	50821			Bracket, Mounting-Gas

15	58804A	306106	Coil, Holding And Booster--W
16	60641	37001007	Harness, Wire
17	Y56229	510205	Valve-Elbo
NI	501885		Not Available HARNESS, WIRE
"	501886		Not Available HARNESS WIRE
"	500694		Not Available ASSY,WIRE HARNESS
"	500695		Not Available ASSY,WIRE HARNESS
"	500692		Not Available ASSY,WIRE HARNESS
"	500693		Not Available ASSY,WIRE HARNESS

