

Amana AEM677W 01 - BULKHEAD/FELT SEAL/CYL ROLLER & TERM BLK

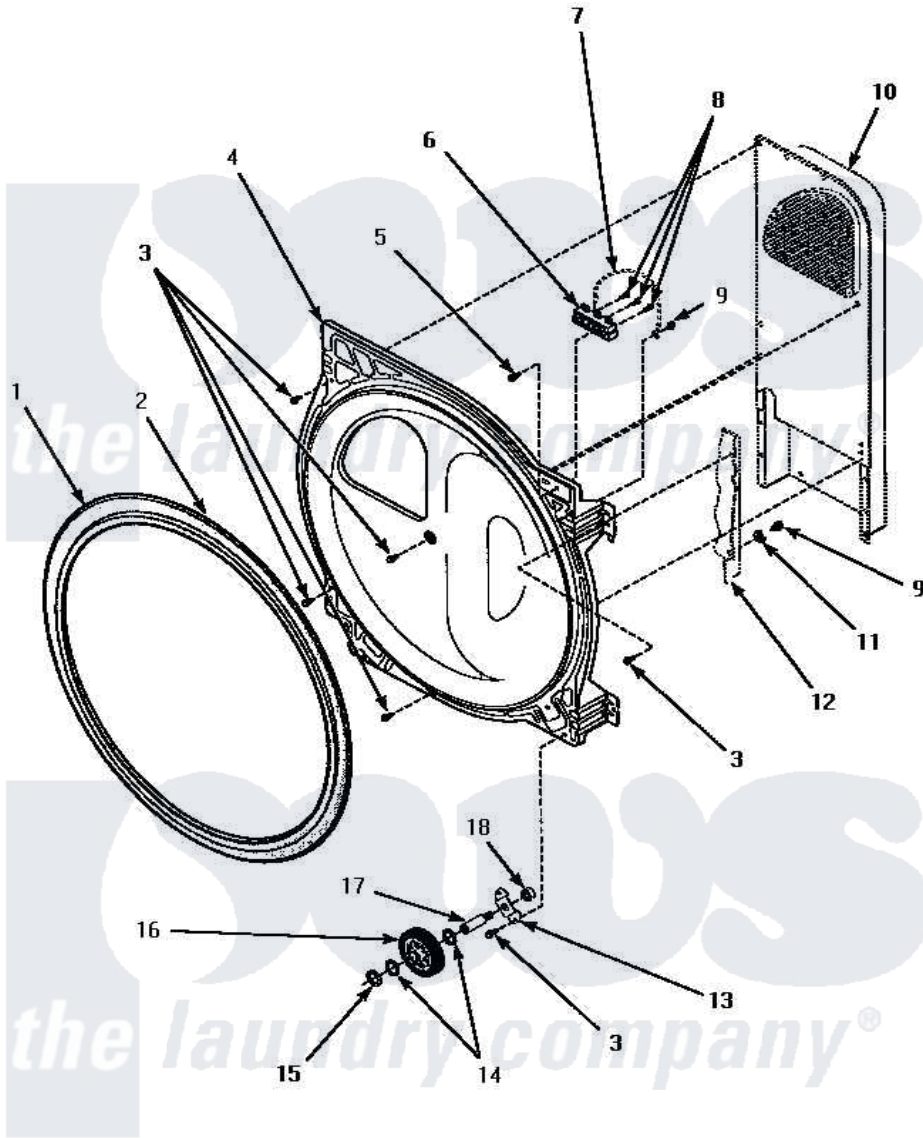

REAR BULKHEAD, FELT SEAL, CYLINDER ROLLER AND TERMINAL BLOCK

Amana [Residential Amana AEM677W Dryer Parts](#) Parts Diagram 01 - BULKHEAD/FELT SEAL/CYL ROLLER & TERM BLK

Click on the part number to view part

Item	Original Part Number	Replaced By	Status	Part Description
1	501801	37001132		Seal, Cylinder
2	22506P	511637P		Adh Dow 737 Clr 3 Oz Tube
3	501668	503688		Screw, 10B-16 X .34 I
4	500356W	502614WP		Bulkhead, Rear
5	501285			Screw, No.12 X 9/16-Pla
6	61923P	61923		Block, Terminal
7	Y00000000		Not Available	SEE NOTE GROUND WIRE, GREEN -- (SEE NOTE)
8	Y61199	3400094		Screw, 10-32 X 3/8
9	20530			Screw, 10-24 x 3/8 Hex
10	Y00000000		Not Available	SEE NOTE HEATER BOX ASSEMBLY
11	51474		Not Available	WASHER, 13/64IDX1/2ODX.
12	Y00000000		Not Available	SEE NOTE CABINET
13	500062	40113601		Assembly, Roller Brkt
14	52549			Washer, 501 ID X3/4 Odx

15	23748		Ring, Retaining
16	500214	37001042	Assembly, Cylinder Roller
17	56461		Shaft
18	56156	358160	Nut

