

**Amana AGM479W2 (BOM: PAGM479W2) 13 - MOTOR CONNECTION
BLOCK, TERMINALS TOOLS**

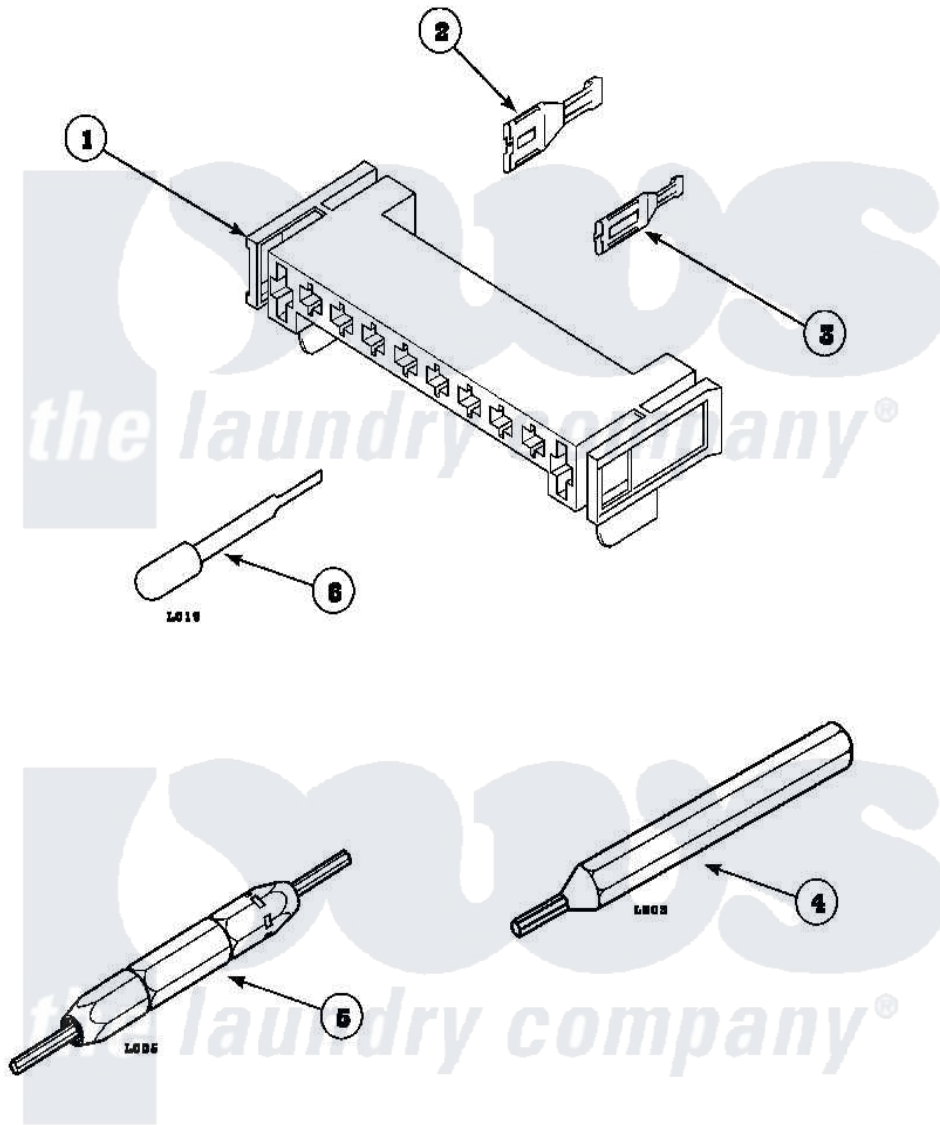

Amana [Residential Amana AGM479W2 \(BOM: PAGM479W2\) Dryer Parts](#) Parts Diagram 13 - MOTOR CONNECTION
BLOCK, TERMINALS TOOLS
[Click on the part number to view part](#)

Item	Original Part Number	Replaced By	Status	Part Description
1	00255		Not Available	(1/4 INCH-FOR (1) 12 GAUGE WIR
"	500338			Housing-10 Position
2	00225		Not Available	SPADE TERMINAL
"	Y00256			Spade Terminal Or
3	Y00188			Molex Terminal
4	128P4		Not Available	(FOR USE ON GAS DRYER TERMINAL
5	190P4			Terminal Extractor Tool
6	283P4			Terminal Extractor Tool