

Amana AGM499L2 12 - MTR CONN BLOCK/TERM & EXTRACTOR TOOL

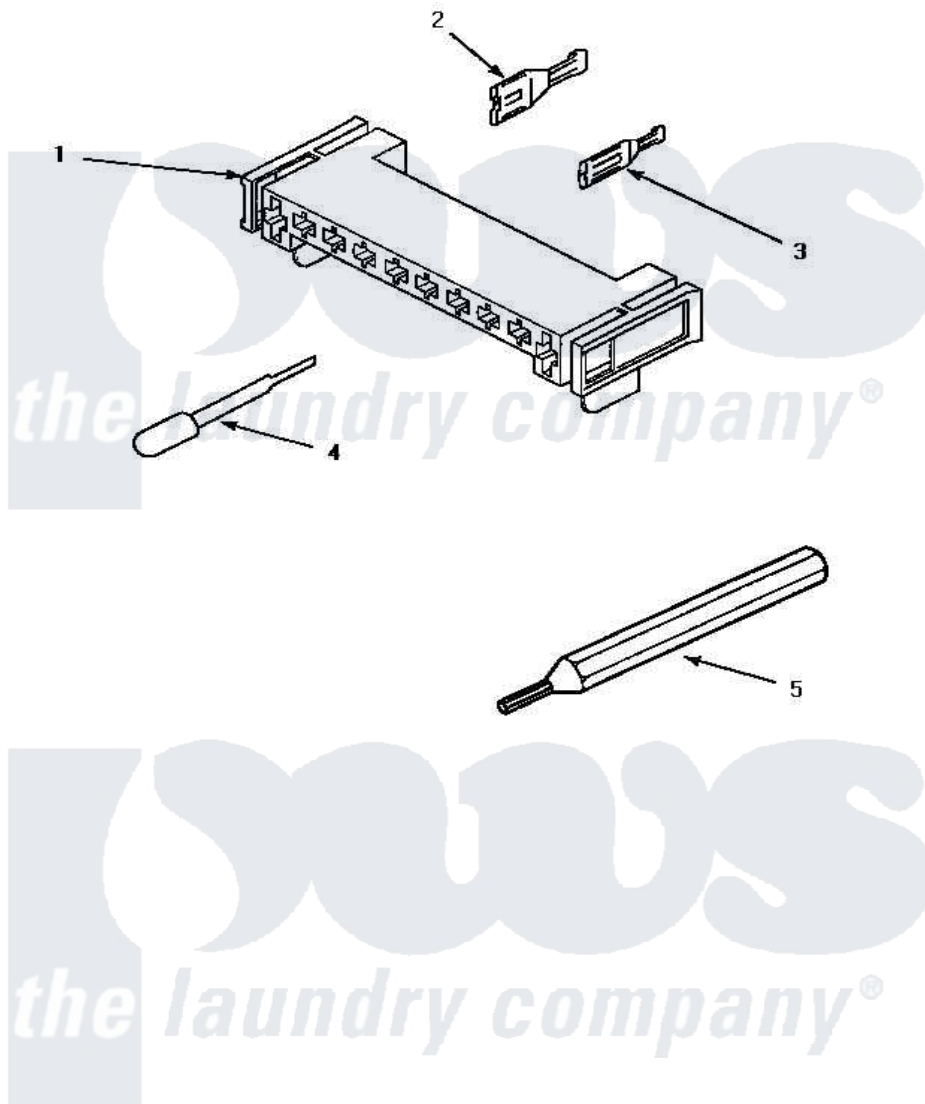

MOTOR CONNECTION BLOCK, TERMINALS AND TERMINAL EXTRACTOR TOOLS

Amana [Residential Amana AGM499L2 Dryer Parts](#) Parts Diagram 12 - MTR CONN BLOCK/TERM & EXTRACTOR
TOOL

[Click on the part number to view part](#)

Item	Original Part Number	Replaced By	Status	Part Description
1	500338			Housing-10 Position
2	00255		Not Available	(1/4 INCH-FOR (1) 12 GAUGE WIR
"	Y00256			Spade Terminal Or
3	Y00188			Molex Terminal
4	283P4			Terminal Extractor Tool
5	128P4		Not Available	(FOR USE ON GAS DRYER TERMINAL