

**Amana AGM679W2 (BOM: PAGM679W2) 13 - MOTOR CONNECTION  
BLOCK, TERMINALS TOOLS**

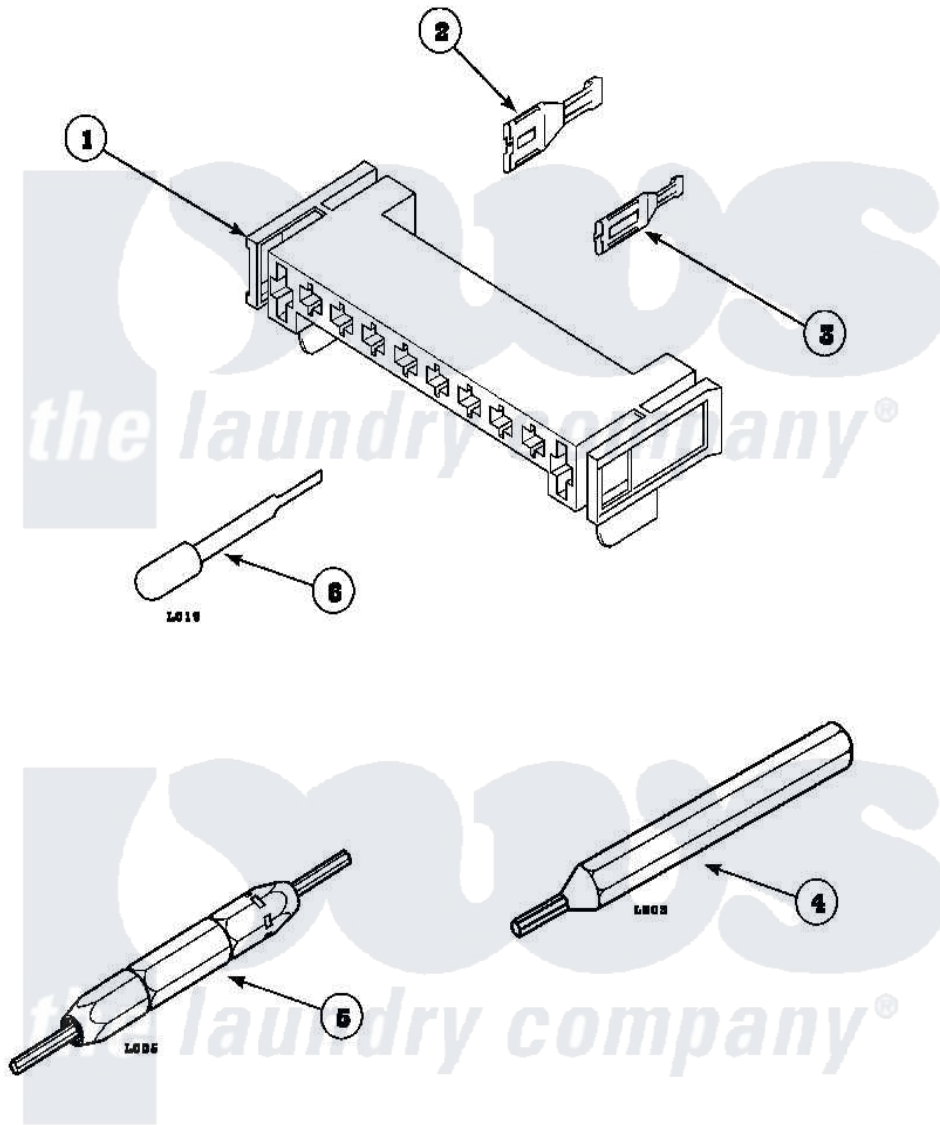

Amana [Residential Amana AGM679W2 \(BOM: PAGM679W2\) Dryer Parts](#) Parts Diagram 13 - MOTOR CONNECTION  
BLOCK, TERMINALS TOOLS  
[Click on the part number to view part](#)

Item	Original Part Number	Replaced By	Status	Part Description
1	00255		Not Available	(1/4 INCH-FOR (1) 12 GAUGE WIR
"	<a href="#">500338</a>			Housing-10 Position
2	00225		Not Available	SPADE TERMINAL
"	<a href="#">Y00256</a>			Spade Terminal Or
3	<a href="#">Y00188</a>			Molex Terminal
4	128P4		Not Available	(FOR USE ON GAS DRYER TERMINAL
5	<a href="#">190P4</a>			Terminal Extractor Tool
6	<a href="#">283P4</a>			Terminal Extractor Tool