

**Amana AGM679W2 (BOM: PAGM679W2) 16 - REAR BLKHD/FELT SEAL/CYL ROLLER & TERM**

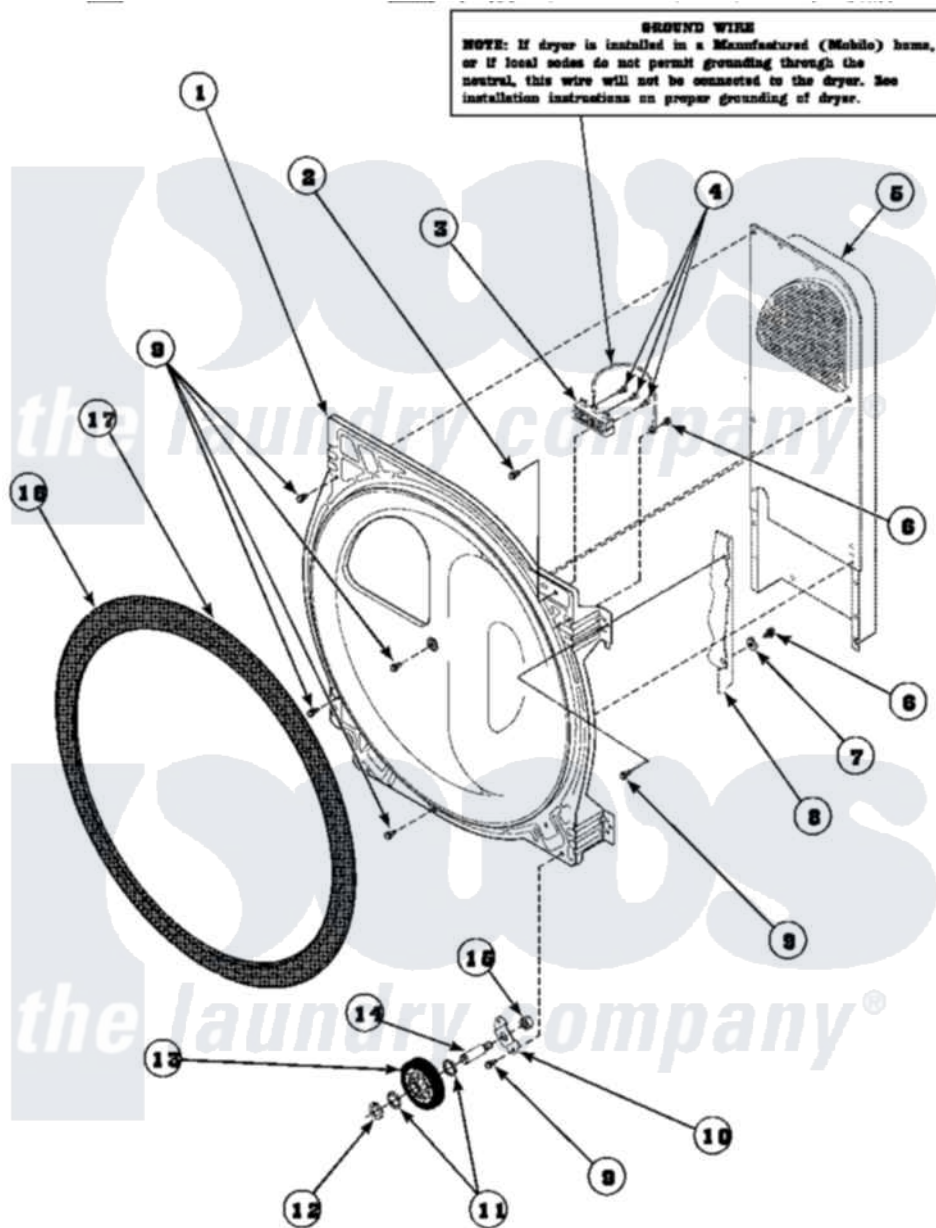

Amana Residential Amana AGM679W2 (BOM: PAGM679W2) Dryer Parts Parts Diagram 16 - REAR BLKHD/FELT SEAL/CYL ROLLER & TERM  
 Click on the part number to view part

Item	Original Part Number	Replaced By	Status	Part Description
1	5002614W		Not Available	REAR BULKHEAD
2	<a href="#">501285</a>			Screw, No.12 X 9/16-Pla
3	61923P	<a href="#">61923</a>		Block, Terminal
4	Y61199	<a href="#">3400094</a>		Screw, 10-32 X 3/8
5	500179P	<a href="#">503605</a>		Assembly, Heater Duct
6	<a href="#">20530</a>			Screw, 10-24 x 3/8 Hex
7	51474		Not Available	WASHER, 13/64IDX1/2ODX.
8	500001P		Not Available	(ADD LETTER BEFORE "P" IN PART
9	501668	<a href="#">503688</a>		Screw, 10B-16 X .34 I
10	500062	<a href="#">40113601</a>		Assembly, Roller Brkt
11	<a href="#">52549</a>			Washer, 501 ID X3/4 Odx
12	<a href="#">23748</a>			Ring, Retaining
13	500214P	<a href="#">37001042</a>		Assembly, Cylinder Roller
14	<a href="#">56461</a>			Shaft

15	56156	<a href="#">358160</a>	Nut
16	501801	<a href="#">37001132</a>	Seal, Cylinder
17	22506P	<a href="#">511637P</a>	Adh Dow 737 Clr 3 Oz Tube

