

Amana AGM699L 05 - GAS VALVE, IGNITER & GAS CONVERSION KITS

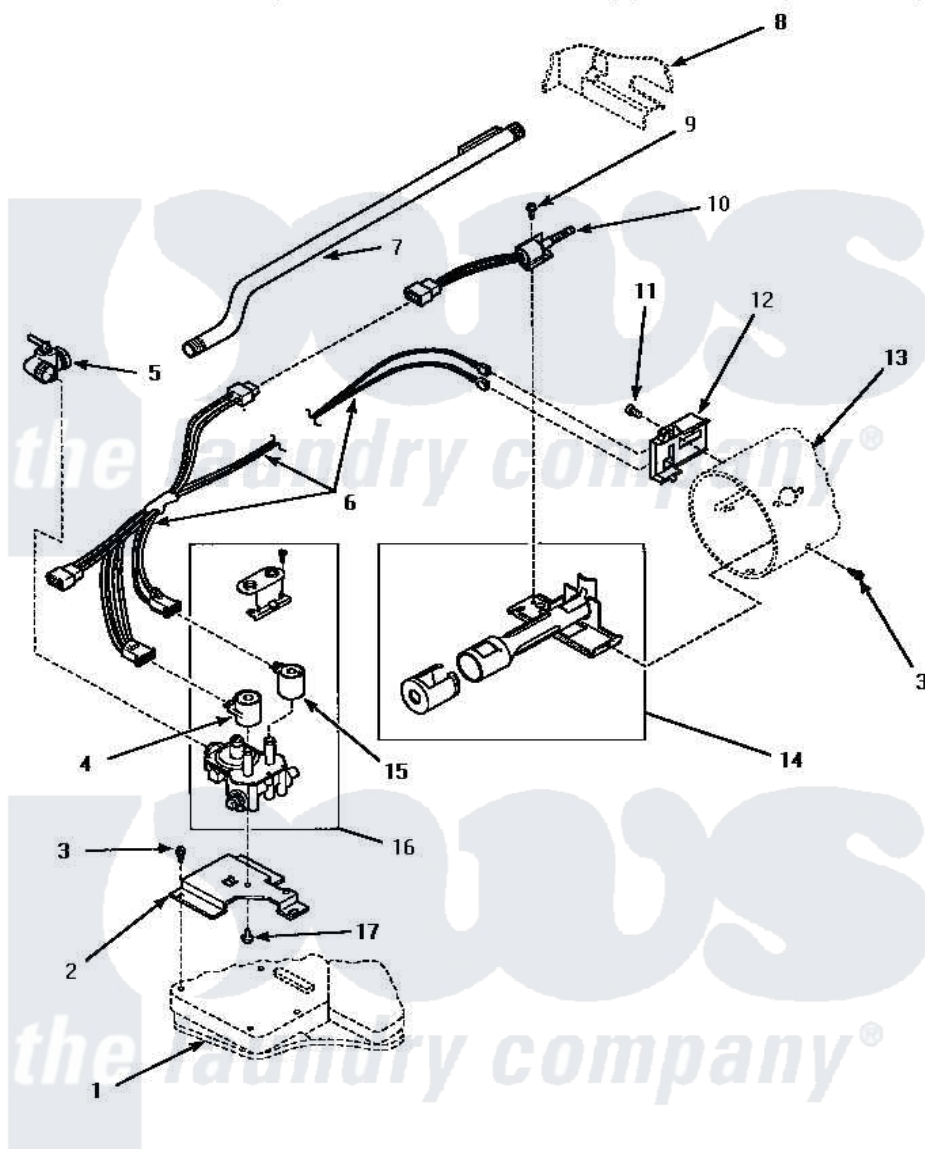

GAS VALVE, IGNITER AND GAS CONVERSION KITS (Gas Model Dryers)

Amana [Residential Amana AGM699L Dryer Parts](#) Parts Diagram 05 - GAS VALVE, IGNITER & GAS CONVERSION KITS

[Click on the part number to view part](#)

Item	Original Part Number	Replaced By	Status	Part Description
1	Y00000000		Not Available	SEE NOTE BASE
2	500821			Bracket, Mounting-Gas
3	501668	503688		Screw, 10B-16 X .34 I
4	58804A	306106		Coil, Holding And Booster-W
5	Y56229	510205		Valve-Elbo
6	60641	37001007		Harness, Wire
7	500647	510204		Pipe
8	Y00000000		Not Available	SEE NOTE CABINET
9	51782		Not Available	SCREW, 6B-20X5/16
10	60868	37001308		Ignitor
11	23222	3177991		Screw
12	Y56231	338906		Radiant, Sensor
13	Y00000000		Not Available	SEE NOTE BURNER HOUSING
14	Y56234	37001304		Burner Ign
15	58804B	694540		Coil, 60 Hz

16	58804		Assembly, Valve-Gas-Single-
17	56124	3370225	Screw
NI	58768	402P3	Kit, Conversion-NG
"	58754	401P3	Kit, Conversion-LP
"	58719	402P3	Kit, Conversion-NG
"	60521	Not Available	STICKER,NG OR MIXED GAS
"	60516		Sticker, Valve Converted
"	60520	Not Available	STICKER,LP GAS
"	58755	401P3	Kit, Conversion-LP
"	61505	Not Available	CONVERSION PLATE
"	401P3		Kit, Conversion-LP
"	402P3		Kit, Conversion-NG
"	61504		Conversion Plate
"	60517		Valve Converted To LP Gas Stic

