

Amana AWM190W2 14 - POWER CORD & TERMINALS

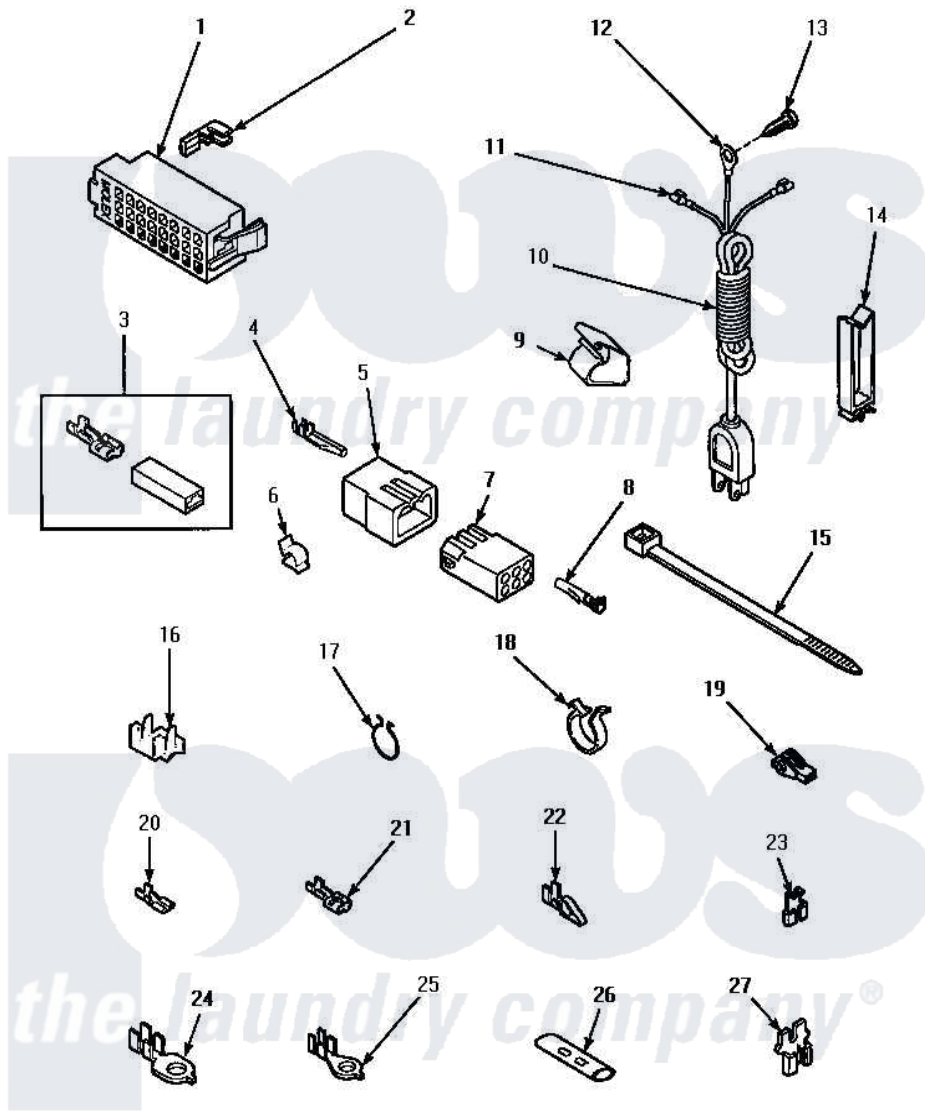

POWER CORD AND TERMINALS

Amana [Residential Amana AWM190W2 Washer Parts](#) Parts Diagram 14 - POWER CORD & TERMINALS
 Click on the part number to view part

Item	Original Part Number	Replaced By	Status	Part Description
1	34123			Housing, LH -24 Position
"	32746			Housing, RH-24 Positi
2	Y00188			Molex Terminal
3	00234	00359		Terminal Ultra Pod 250 X032F
4	Y00116			Terminal, Pin-Male
5	23041			Plug, 6 Circuit
"	23033			Plug, 9 Circuit
"	26302		Not Available	PLUG,1 CIRCUIT
6	21036			Clip, Cable
7	26708			Receptacle, 6 Circuit
"	26301			Receptacle, Molex
"	26163			Receptacle, 9 Circuit
8	Y00117	5011-XX		093 Female Socket
9	35521		Not Available	CLIP, HARNESS HOLDER
10	Y34458		Not Available	POWER CORD ALL
11	03673		Not Available	NUT

12	Y0000000	Not Available	SEE NOTE GROUND WIRE
13	52909		Screw, 10B-16 X 1/2 HeX
14	36274	Not Available	CLIP, HARNESS
15	36466	M0321209	Tie-Electrical
16	Y00161	B5733302	Clip, Ground
17	51291		Clip, Wire
18	61510	504034	Clip, Wire
19	70210	Not Available	INSULATOR,BLUE
20	00112		Terminal, Spade-3/16 Fe
21	Y00119	Not Available	SPADE TERMINAL(18 GAUGE) (1/4 INCH-(1) 18 GAUGE WIRE)
22	00220	Not Available	TERMINAL,CRIMP-SINGLE
23	Y00120		Terminal, Flag-1/4 Fema
24	Y00113	Not Available	TERMINAL,RING-1/4 STUD
25	00110		No.10 18 Gauge Wire
26	21091	Not Available	CONNECTOR TWO 1/4 INCH MALE
27	29673	Not Available	DOUBLE CONNECTOR

