

# Amana AWM352 15 - MOTOR, MTG BRACKET, BELTS & IDLER ASSY

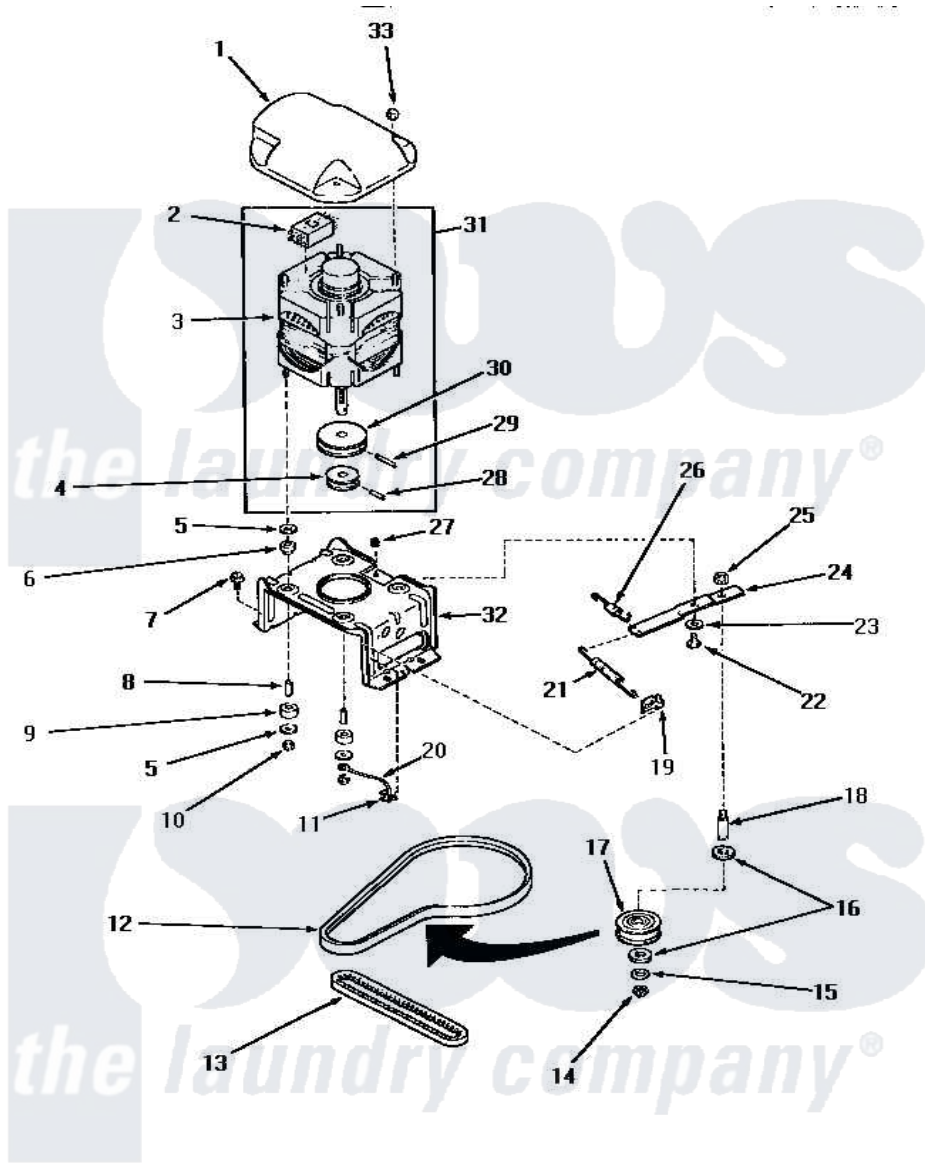

## MOTOR, MOUNTING BRACKET, BELTS AND IDLER ASSEMBLY

Amana [Residential Amana AWM352 Washer Parts](#) Parts Diagram 15 - MOTOR, MTG BRACKET, BELTS & IDLER ASSY

[Click on the part number to view part](#)

Item	Original Part Number	Replaced By	Status	Part Description
1	<a href="#">27136</a>			Shield, Motor
2	38097A		Not Available	MOTOR SWITCH
"	30895A	<a href="#">30895AP</a>		Switch Motor-W/Instr
"	24140		Not Available	SWITCH,MOTOR
"	24139		Not Available	SWITCH,MOTOR
3	30897	<a href="#">27179P</a>		Motor-Drve
4	Y27104		Not Available	PULLEY,MOTOR
5	03888		Not Available	WASHER
6	<a href="#">01952A</a>			Mounting, Rubber
7	Y31645	<a href="#">27001200</a>		Screw
8	27181		Not Available	SPACER,MOTOR
9	01953		Not Available	WASHER,LOWER MOTOR MOU
10	<a href="#">23604</a>			Nut, Hex 10-32 Lock
11	Y00161	<a href="#">B5733302</a>		Clip, Ground
12	<a href="#">28808</a>			Belt, Agitate And Spin

13	<a href="#">27155</a>		Belt, Pump
14	<a href="#">23748</a>		Ring, Retaining
15	<a href="#">52549</a>		Washer, 501 ID X3/4 Odx
16	<a href="#">Y29443</a>		Washer, Felt
17	28800	Not Available	WHEEL, IDLER
18	<a href="#">28802</a>		Shaft, Idler
19	<a href="#">28849</a>		Clip, Spring
20	Y00000000	Not Available	SEE NOTE GROUND WIRE, GREEN
21	28807	<a href="#">37366</a>	Spring, Idler
22	27229	<a href="#">40038901</a>	Screw, 1/4-20
23	81392	<a href="#">40054701</a>	Washer
24	31054	<a href="#">40041002</a>	Lever, Idler
25	28803	<a href="#">2221070</a>	Clamp, Nylon
26	30620	Not Available	SPRING, IDLER LEVER HEL
27	52566	<a href="#">27001225</a>	Nut, Jam Mid Lock 1/4-20
28	<a href="#">10416</a>		Pin, Roll
29	<a href="#">23750</a>		Pin, Roll
30	27171	Not Available	PULLEY, MOTOR
31	27658	<a href="#">27179P</a>	Motor-Drve
32	<a href="#">28791</a>		Bracket, Motor Mount
33	<a href="#">27201</a>		Locknut
NI	20605	Not Available	LUBE, HI TEMPERATURE-56
"	258P3	Not Available	KIT, CAPACITOR

*the laundry company*<sup>®</sup>

*the laundry company*<sup>®</sup>