

# Amana AWM352 22 - WIRE TERMINALS

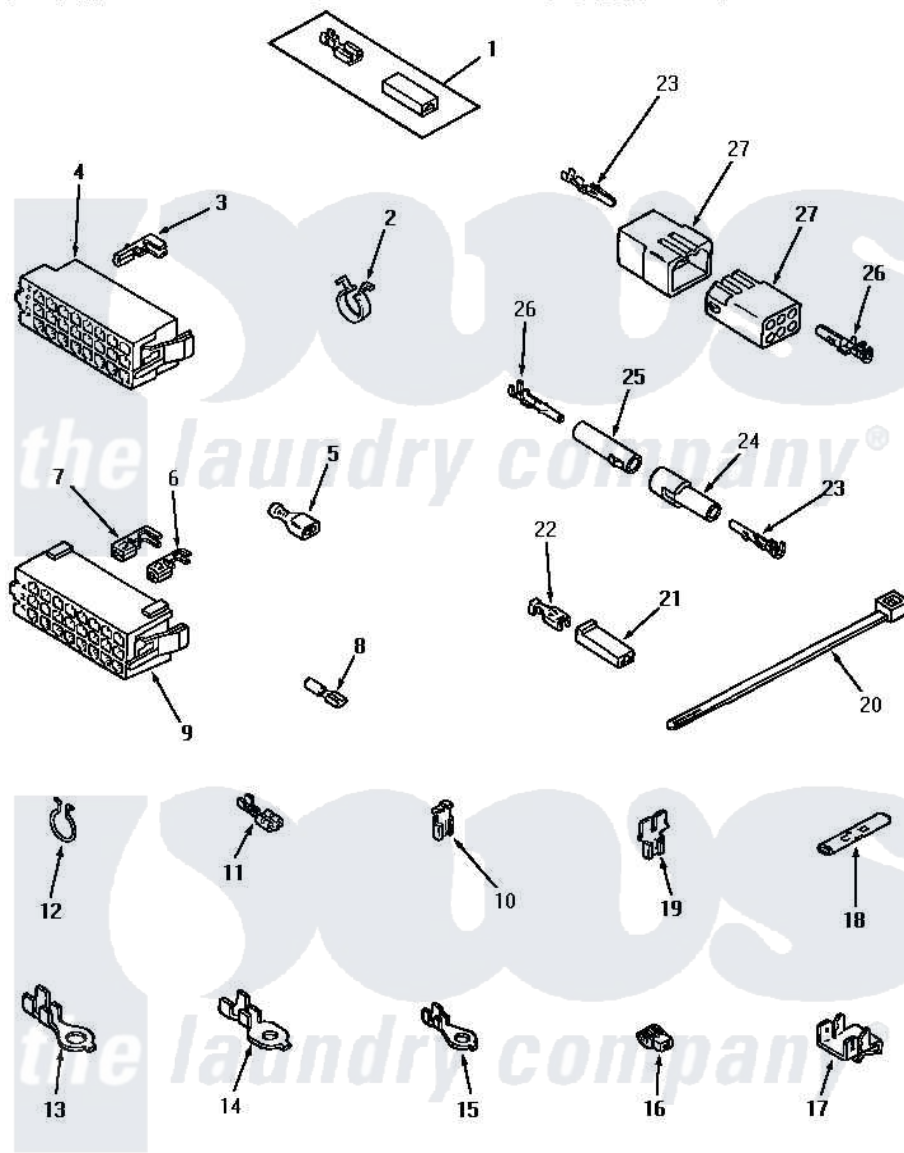

## WIRE TERMINALS

Amana [Residential Amana AWM352 Washer Parts](#) Parts Diagram 22 - WIRE TERMINALS  
 Click on the part number to view part

Item	Original Part Number	Replaced By	Status	Part Description
1	00234	<a href="#">00359</a>		Terminal Ultra Pod 250 X032F
2	61510	<a href="#">504034</a>		Clip, Wire
3	<a href="#">Y00188</a>			Molex Terminal
4	<a href="#">34123</a>			Housing, LH -24 Position
"	<a href="#">32746</a>			Housing, RH-24 Positi
5	Y00163	<a href="#">285432</a>		Terminal
"	<a href="#">Y00165</a>			Insulated Spade Terminal
6	00180		Not Available	TERMINAL,FEMALE
7	00183		Not Available	TERMINAL,FEMALE 2-WIRE
8	<a href="#">Y00215</a>			Barrel Insulated Spade
"	Y00214		Not Available	BARREL INSULATED SPADE(18 GAUG (1/4 INCH-18 GAUGE WIRE)
9	28856		Not Available	HOUSING,24 POSITION
10	<a href="#">Y00120</a>			Terminal, Flag-1/4 Fema
11	Y00119		Not Available	SPADE TERMINAL(18 GAUGE) (1/4 INCH-(1) 18 GAUGE WIRE)

"	Y00121		Not Available	SPADE TERMINAL(12 GAUGE) (1/4 INCH-(2) 18 GAUGE WIRES O
12	<a href="#">51291</a>			Clip, Wire
13	Y00113		Not Available	TERMINAL,RING-1/4 STUD
14	<a href="#">Y00111</a>			Ring Terminal No.10 No.10 18 Gauge Wires Or
15	<a href="#">00110</a>			No.10 18 Gauge Wire
16	70210		Not Available	INSULATOR,BLUE
17	Y00161	<a href="#">B5733302</a>		Clip, Ground
18	21091		Not Available	CONNECTOR TWO 1/4 INCH MALE
19	29673		Not Available	DOUBLE CONNECTOR
20	55881	<a href="#">M0321209</a>		Tie-Electrical
21	<a href="#">90789</a>			Connector
22	<a href="#">Y00115</a>			Lock In Spade Terminal (18 Gaug (1/4 Inch-(1) 18 Gauge Wire)
23	<a href="#">Y00116</a>			Terminal, Pin-Male
24	26302		Not Available	PLUG,1 CIRCUIT
25	<a href="#">26301</a>			Receptacle, Molex
26	Y00117	<a href="#">5011-XX</a>		093 Female Socket
27	<a href="#">26708</a>			Receptacle, 6 Circuit
28	<a href="#">23041</a>			Plug, 6 Circuit

