

# Amana AWM372W2 10 - MIX VLV/MTR CONN BLKS/TERM & EXTRACTOR

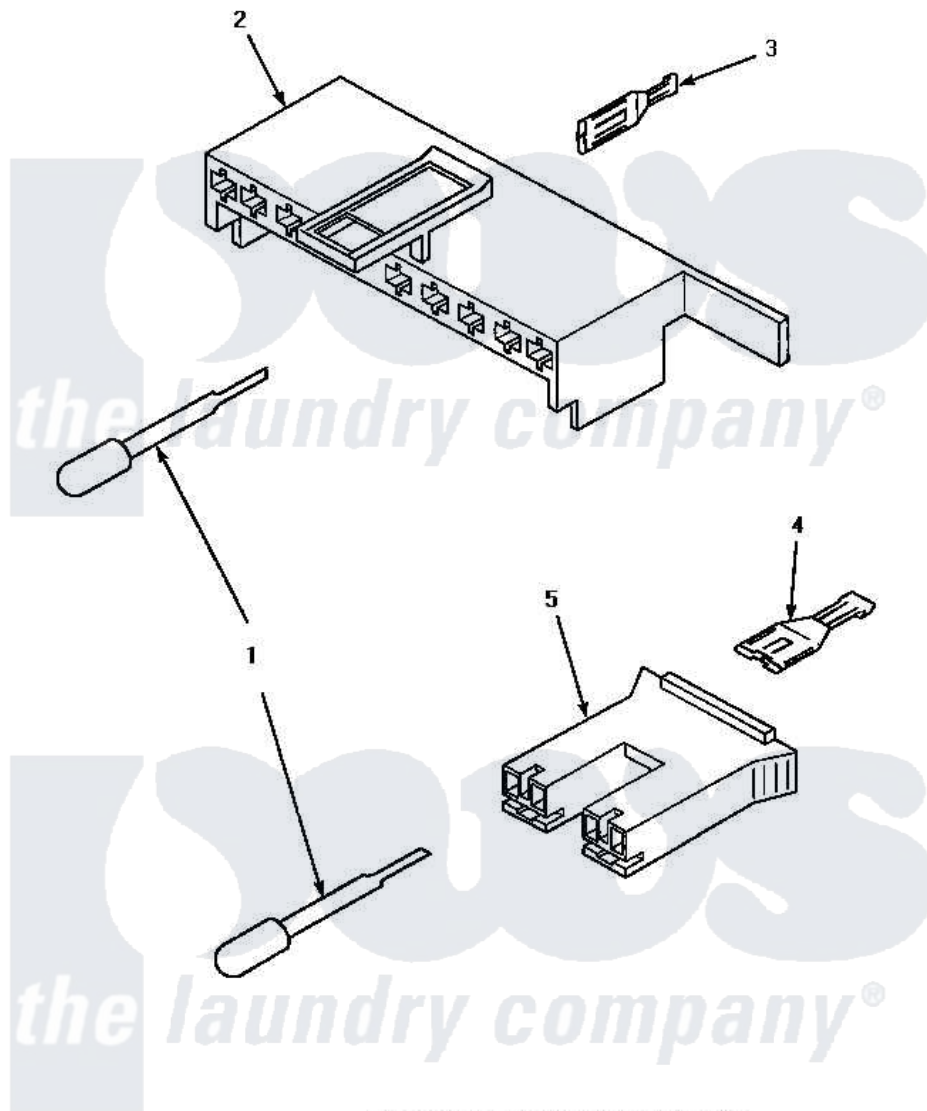

**MIXING VALVE AND MOTOR CONNECTION BLOCKS, TERMINALS AND TERMINAL EXTRACTOR TOOL**

Amana [Residential Amana AWM372W2 Washer Parts](#) Parts Diagram 10 - MIX VLV/MTR CONN BLKS/TERM & EXTRACTOR

[Click on the part number to view part](#)

Item	Original Part Number	Replaced By	Status	Part Description
1	<a href="#">283P4</a>			Terminal Extractor Tool
2	<a href="#">34677</a>			10 Circuit Plug
3	<a href="#">Y00188</a>			Molex Terminal
4	Y00121		Not Available	SPADE TERMINAL(12 GAUGE) (1/4 INCH-(2) 18 GAUGE WIRES O
5	<a href="#">34676</a>			Plug
"	34675		Not Available	PLUG