

# Amana AWM392L2 09 - INLET/FILL HOSE & MIXING VLV MTG BRKT

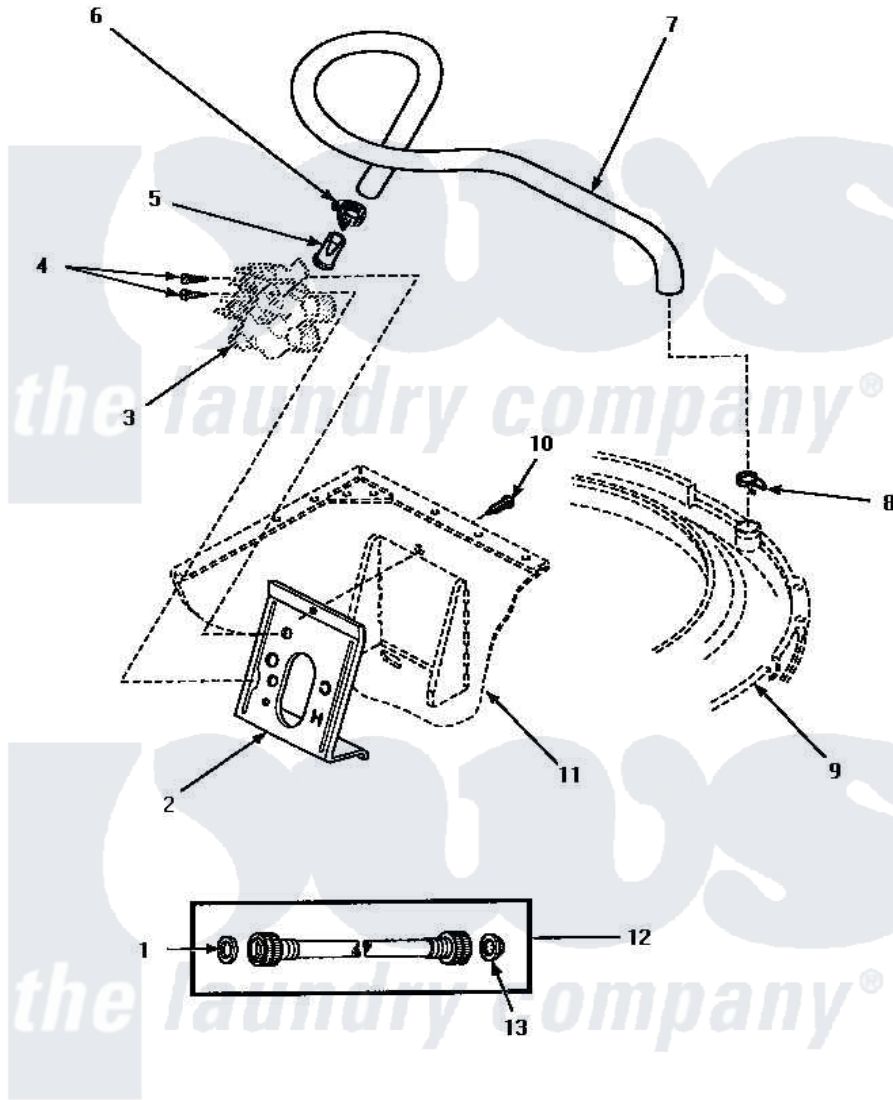

**INLET HOSE, FILL HOSE AND MIXING VALVE MOUNTING BRACKET**

Amana [Residential Amana AWM392L2 Washer Parts](#) Parts Diagram 09 - INLET/FILL HOSE & MIXING VLV MTG BRKT  
 Click on the part number to view part

Item	Original Part Number	Replaced By	Status	Part Description
1	20290	<a href="#">Y013783</a>		Washer, Inlet Hose
2	34972	<a href="#">39407</a>		Bracket, Valve
3	Y00000000		Not Available	SEE NOTE MIXING VALVE ASSEMBLY -- (SEE MIXING VALVE ASSEMBLY PAGE)
4	23962	<a href="#">W10116760</a>		Screw
5	34500	<a href="#">22001900</a>		Preventer, Back Flow
6	36801	<a href="#">596669</a>		Clamp, Manifold
7	35874	<a href="#">38155</a>		Hose, Mix Valve To TU
8	<a href="#">29210</a>			Hose Clamp
9	Y00000000		Not Available	SEE NOTE OUTER TUB COVER ASSY -- (SEE OUTER TUB, COVER AND PRESSURE HOSE PAGE)
10	33562	<a href="#">27001200</a>		Screw
11	Y00000000		Not Available	SEE NOTE CABINET ASSY -- (SEE FRONT PANEL, BASE AND CABINET ASSY PAGE)
12	28330P	<a href="#">202860</a>		Inlet Hose Assembly

