

Amana AWM393W2 04 - BRG HSG/BRAKE/PULLEY & PIVOT DOME

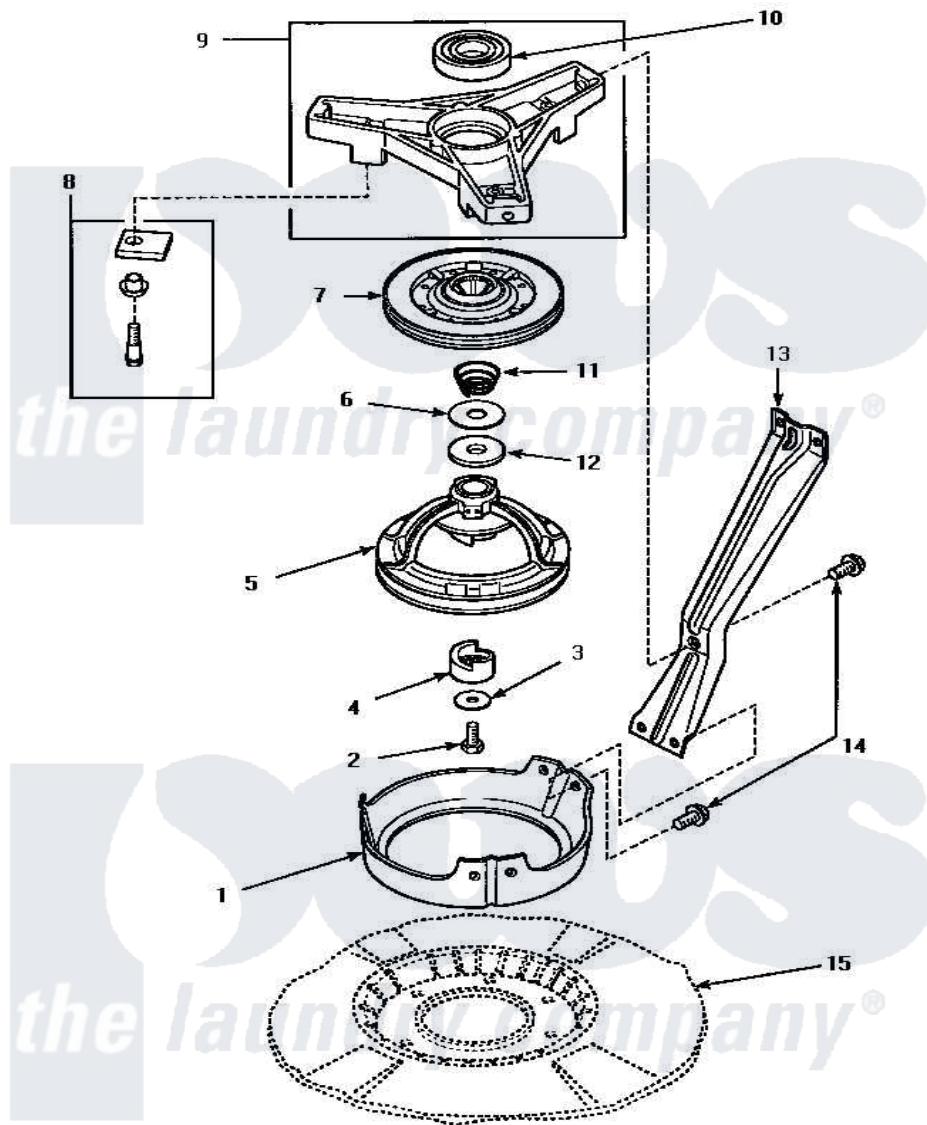

BEARING HOUSING, BRAKE, PULLEY AND PIVOT DOME

Amana [Residential Amana AWM393W2 Washer Parts](#) Parts Diagram 04 - BRG HSG/BRAKE/PULLEY & PIVOT DOME
 Click on the part number to view part

Item	Original Part Number	Replaced By	Status	Part Description
1	34470			Dome, Pivot
2	27220	40063401		Screw, 1/4-20 x 5/8 Hex
3	26509	40041501		Washer
4	27018			Helix
5	34921			Assembly, Pulley-Spin And Agitate
6	35535	40065701		Washer, 2 Odx.63 ID
7	31961P	R9900474		Brake Assembly
8	548P3	R9900543		Pad-Brake
9	35746			AssemBly, Bearing Housing-L
10	28944R	40004001		Bearing, Main
11	33435			Spring, Conical
12	27015	40063201		Washer, Flat
13	34471		Not Available	LEG,SUPPORT
14	35369	40128701		Screw, 5/16-18 X .50
15	Y00000000		Not Available	SEE NOTE BASE ASSY -- (SEE FRONT PANEL, BASE

