

Amana AWM393W2 09 - INLET/FILL HOSE & MIXING VLV MTG BRKT

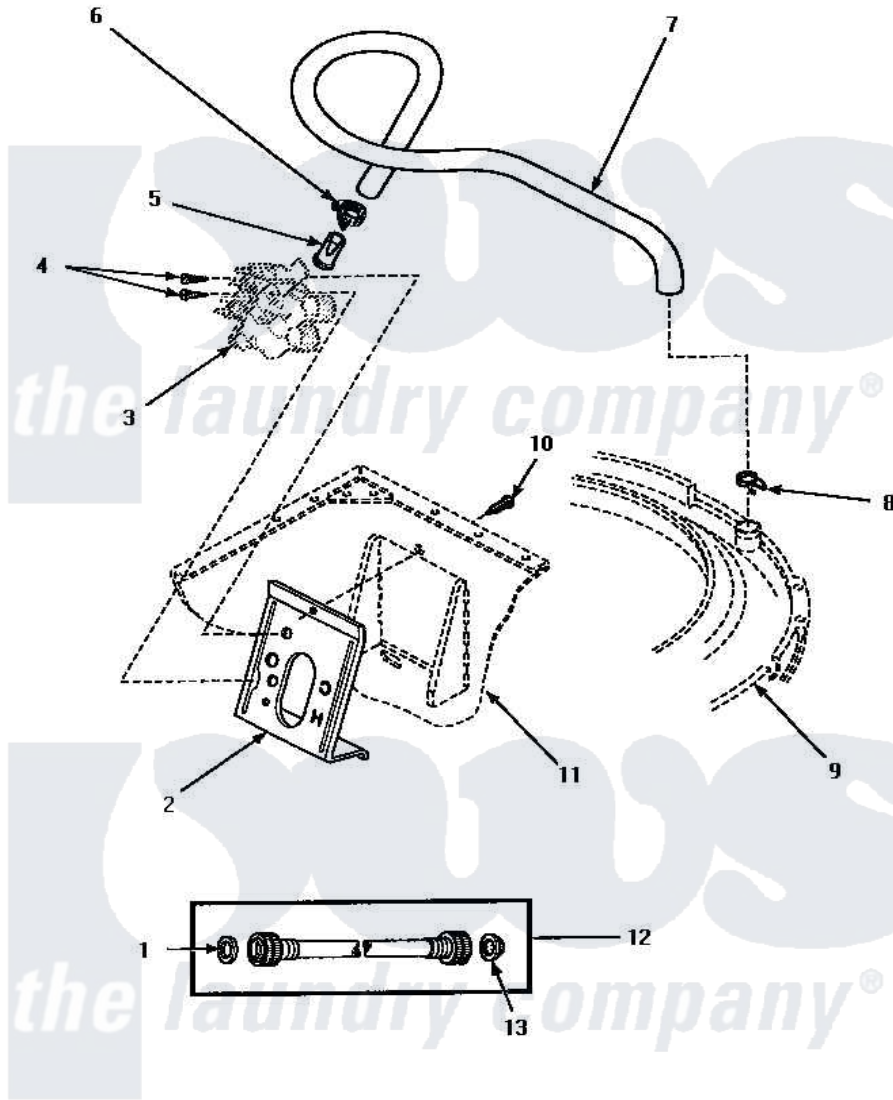

INLET HOSE, FILL HOSE AND MIXING VALVE MOUNTING BRACKET

Amana [Residential Amana AWM393W2 Washer Parts](#) Parts Diagram 09 - INLET/FILL HOSE & MIXING VLV MTG BRKT

[Click on the part number to view part](#)

Item	Original Part Number	Replaced By	Status	Part Description
1	20290	Y013783		Washer, Inlet Hose
2	34972	39407		Bracket, Valve
3	Y00000000		Not Available	SEE NOTE MIXING VALVE ASSEMBLY -- (SEE MIXING VALVE ASSEMBLY PAGE)
4	23962	W10116760		Screw
5	34500	22001900		Preventer, Back Flow
6	36801	596669		Clamp, Manifold
7	35874	38155		Hose, Mix Valve To TU
8	29210			Hose Clamp
9	Y00000000		Not Available	SEE NOTE OUTER TUB COVER ASSY -- (SEE OUTER TUB, COVER AND PRESSURE HOSE PAGE)
10	33562	27001200		Screw
11	Y00000000		Not Available	SEE NOTE CABINET ASSY -- (SEE FRONT PANEL, BASE AND CABINET ASSY PAGE)

