

# Amana AWM393W2 13 - OUT-OF-BALANCE SWITCH

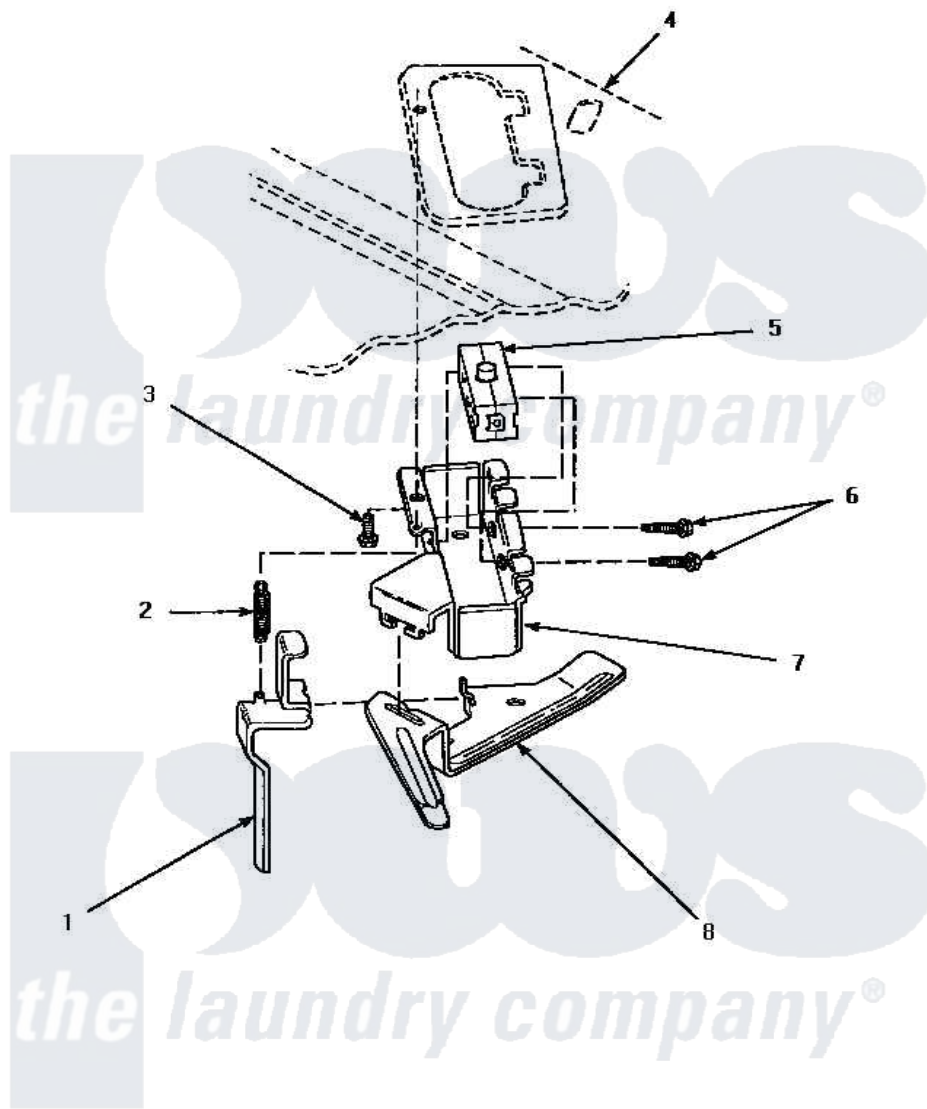

## OUT-OF-BALANCE SWITCH

Amana [Residential Amana AWM393W2 Washer Parts](#) Parts Diagram 13 - OUT-OF-BALANCE SWITCH  
 Click on the part number to view part

Item	Original Part Number	Replaced By	Status	Part Description
1	<a href="#">33442</a>			Lever, Unbalanced Load
2	<a href="#">33443</a>			Spring
3	23962	<a href="#">W10116760</a>		Screw
4	Y00000000		Not Available	SEE NOTE CABINET TOP -- (SEE CABINET TOP, LOADING DOOR AND CONTROL HOOD REAR PANEL PAGE)
5	33445	<a href="#">27001095</a>		Switch, Lid
6	<a href="#">36510</a>			Screw
7	<a href="#">36497P</a>			Kit, Switch Holder
8	<a href="#">33441</a>			Arm, Actuator