

# Amana AWM452 09 - FRONT PANEL, CABINET & BASE

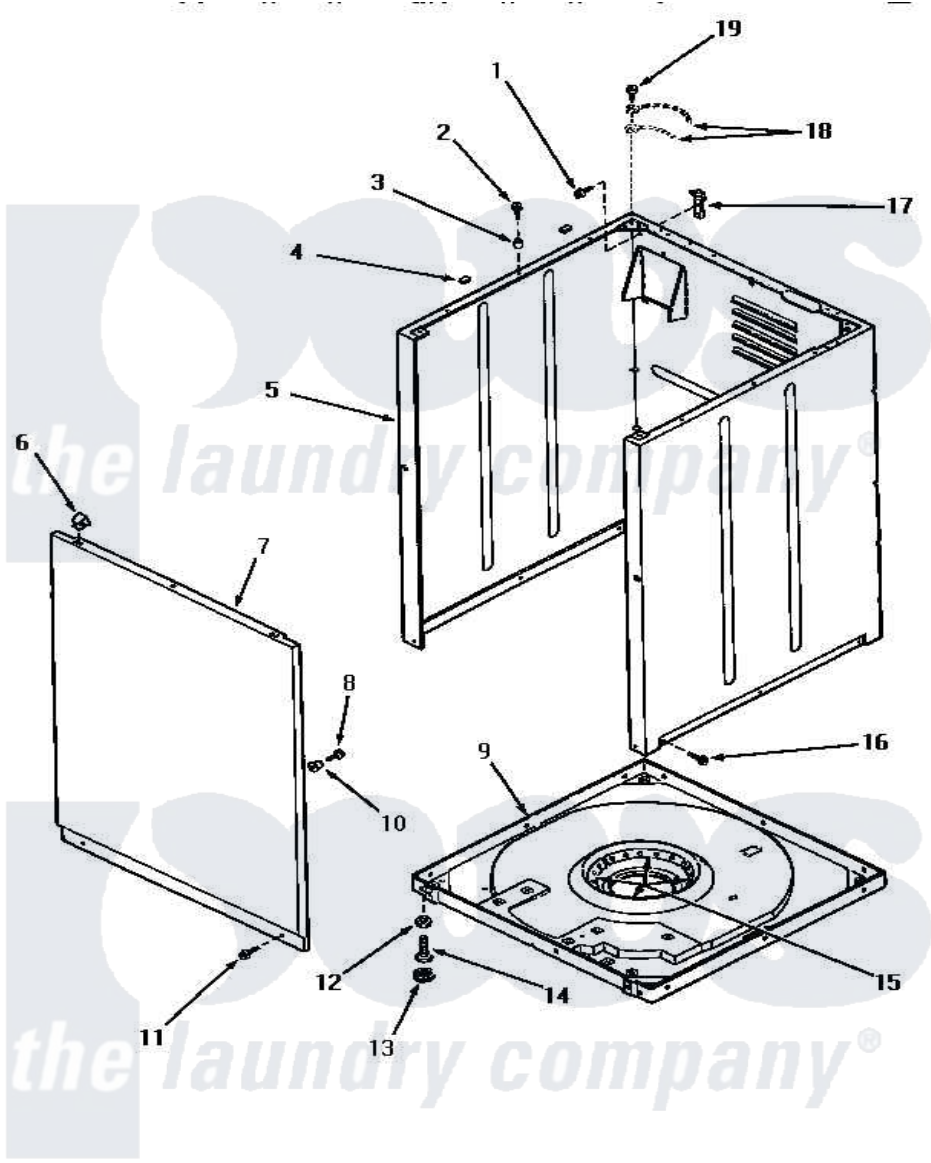

## FRONT PANEL, CABINET AND BASE

Amana [Residential Amana AWM452 Washer Parts](#) Parts Diagram 09 - FRONT PANEL, CABINET & BASE  
 Click on the part number to view part

Item	Original Part Number	Replaced By	Status	Part Description
1	51780	<a href="#">3390631</a>		Screw, 10-16 X 3/8
2	32671	<a href="#">Y014874</a>		Screw, Idler Arm And Sleeve
3	56079	<a href="#">505187</a>		Locator, Panel
4	<a href="#">Y56128</a>			Pad, Bumper
5	31669HP		Not Available	REPL BY 34475HP
"	31669WP	<a href="#">38612WP</a>		Kit-Service
"	31669LP	<a href="#">38612LP</a>		Kit Service Cabinet
6	28835	<a href="#">22001650</a>		Fastener, Spring
7	32708W	<a href="#">32708WP</a>		Panel Front
"	32708H		Not Available	PANEL,FRONT
"	32708L	<a href="#">32708LP</a>		Panel, Front
8	32671	<a href="#">Y014874</a>		Screw, Idler Arm And Sleeve
9	<a href="#">31653P</a>			Assembly, Base-Complete-G90
10	<a href="#">28102</a>			Locator, Panel
11	27196	<a href="#">27001200</a>		Screw
12	Y21899	<a href="#">40038101</a>		Nut, Leg

13	21749	<a href="#">40016001</a>	Foot, Rubber
14	20409	<a href="#">22003428</a>	Leg, Adjustable
15	434P3	Not Available	KIT, SNUBBER PAD
16	27196	<a href="#">27001200</a>	Screw
17	<a href="#">Y27103</a>		Hinge, Hold-Down Lug
18	Y00000000	Not Available	SEE NOTE GROUND WIRES -- (GREEN)
19	56392	Not Available	SCREW, 8-18 X 3/8 TAPPI
NI	<a href="#">26594P</a>		Grease, Silicone - 2 Oz Tube

