

Amana AWM573W2 13 - OUT-OF-BALANCE SWITCH

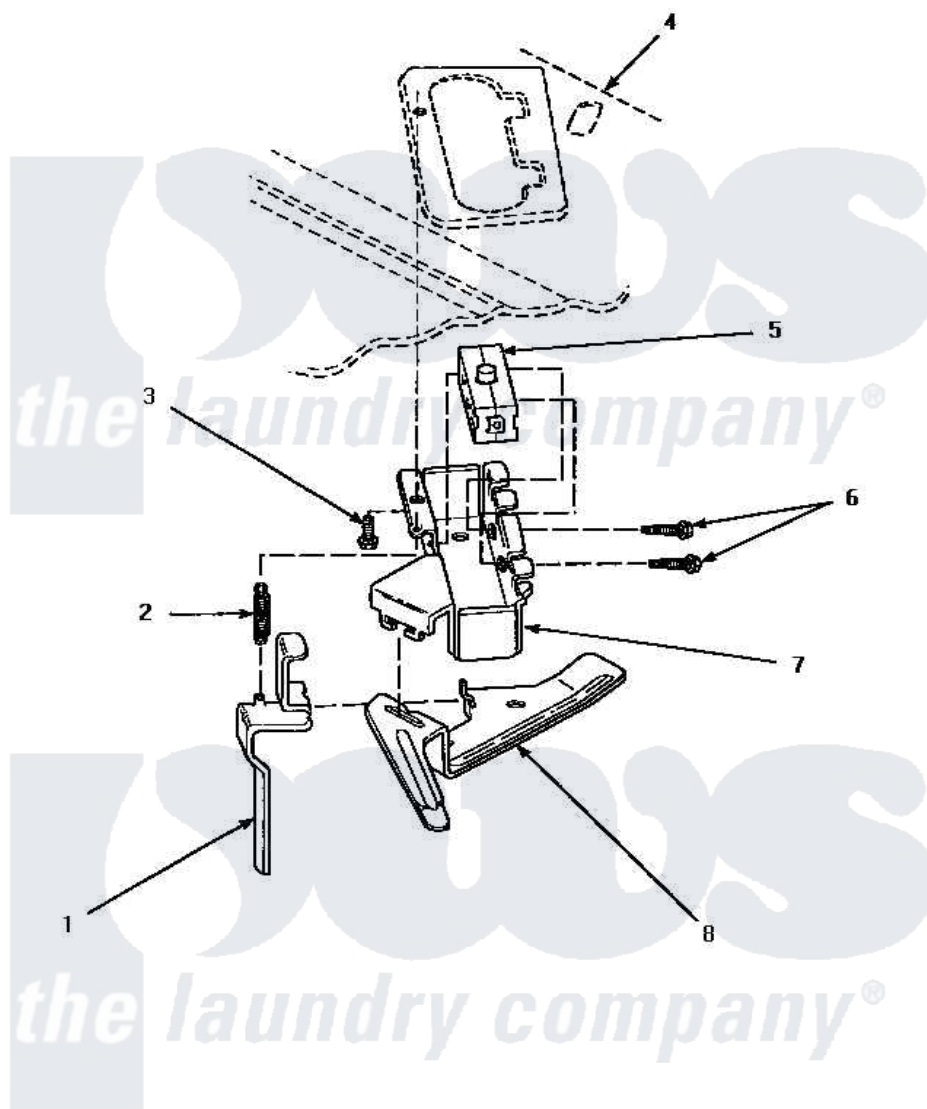

OUT-OF-BALANCE SWITCH

Amana [Residential Amana AWM573W2 Washer Parts](#) Parts Diagram 13 - OUT-OF-BALANCE SWITCH
 Click on the part number to view part

Item	Original Part Number	Replaced By	Status	Part Description
1	33442			Lever, Unbalanced Load
2	33443			Spring
3	23962	W10116760		Screw
4	Y00000000		Not Available	SEE NOTE CABINET TOP -- (SEE CABINET TOP, LOADING DOOR AND CONTROL HOOD REAR PANEL PAGE)
5	33445	27001095		Switch, Lid
6	36510			Screw
7	36497P			Kit, Switch Holder
8	33441			Arm, Actuator