

Amana AWM593L2 10 - MIX VLV/MTR CONN BLKS/TERM & EXTRACTOR

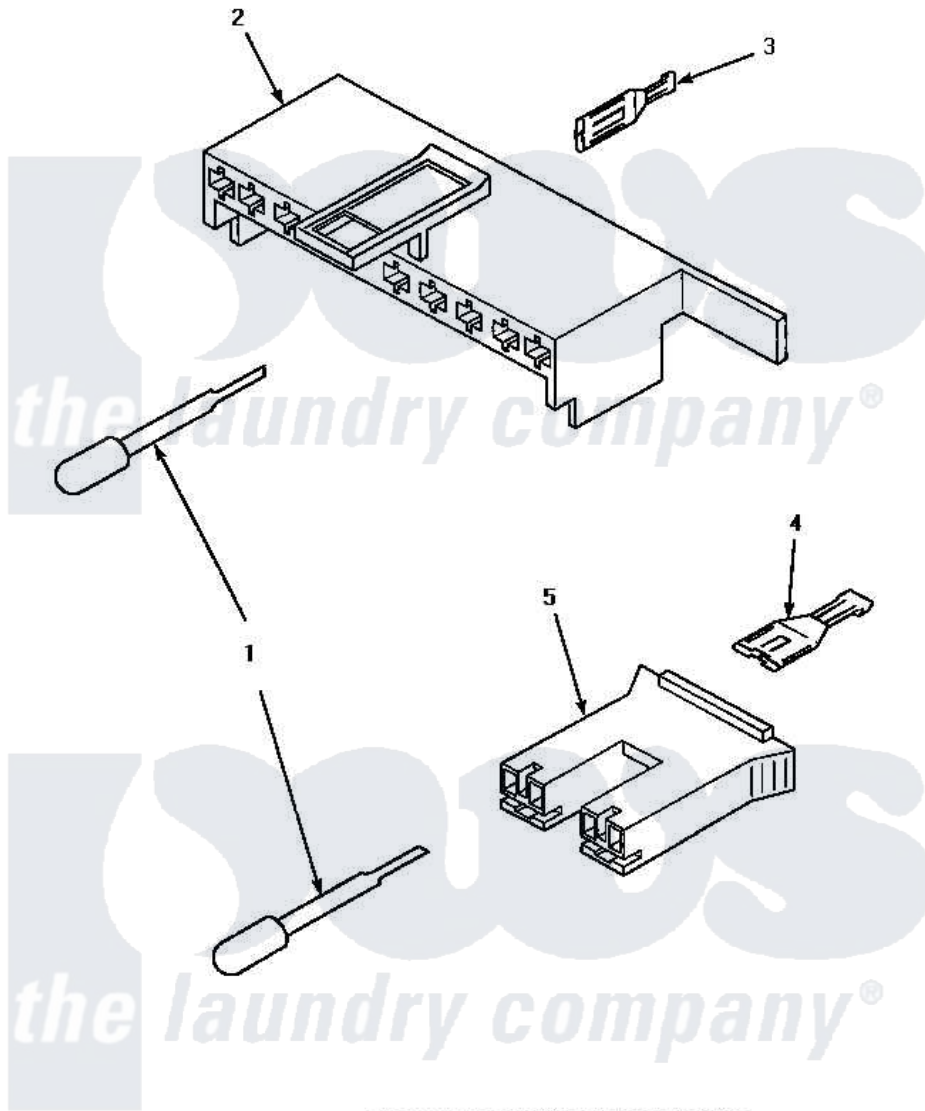

MIXING VALVE AND MOTOR CONNECTION BLOCKS, TERMINALS AND TERMINAL EXTRACTOR TOOL

Amana [Residential Amana AWM593L2 Washer Parts](#) Parts Diagram 10 - MIX VLV/MTR CONN BLKS/TERM & EXTRACTOR

[Click on the part number to view part](#)

Item	Original Part Number	Replaced By	Status	Part Description
1	283P4			Terminal Extractor Tool
2	34677			10 Circuit Plug
3	Y00188			Molex Terminal
4	Y00121		Not Available	SPADE TERMINAL(12 GAUGE) (1/4 INCH-(2) 18 GAUGE WIRES O
5	34676			Plug
"	34675		Not Available	PLUG