

Amana CE9207W (BOM: PCE9207W) 01 - BULKHEAD/FELT SEAL/CYL ROLLER & TERM BLK

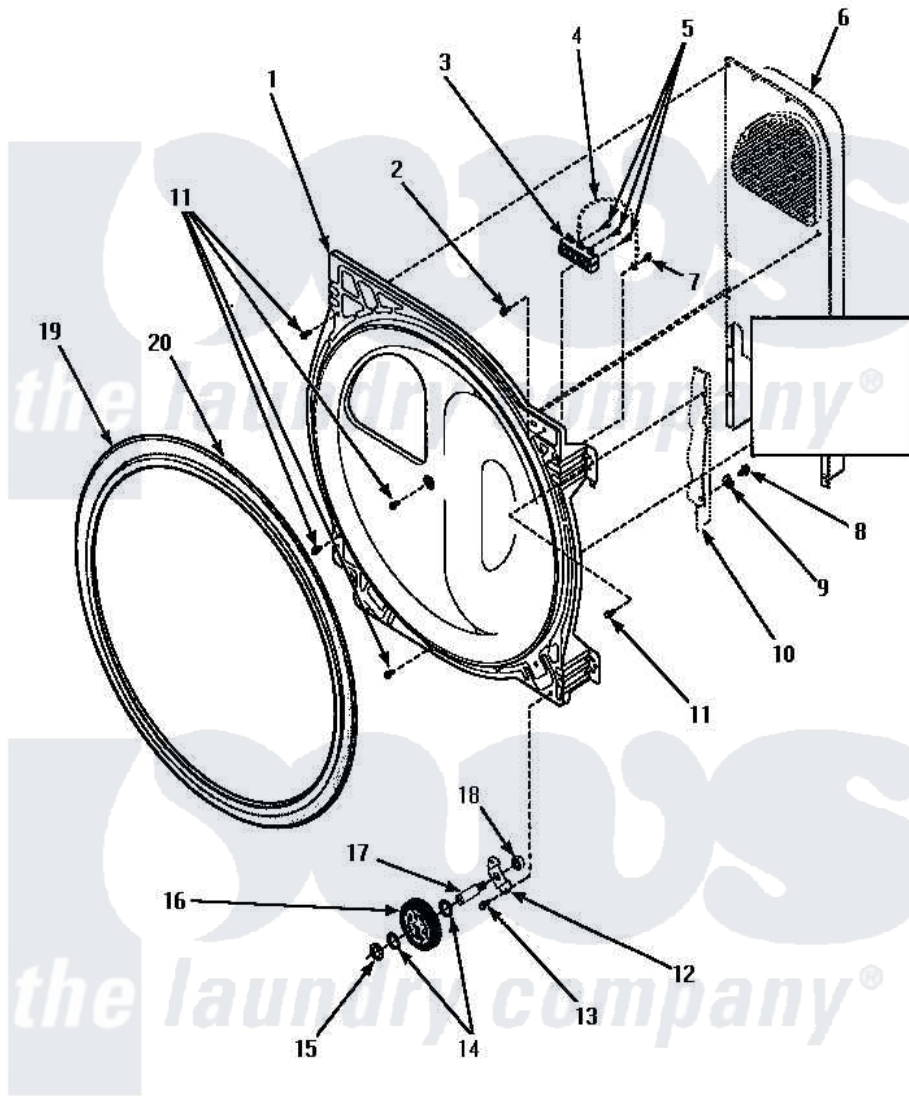

REAR BULKHEAD, FELT SEAL, CYLINDER ROLLER AND TERMINAL BLOCK

Amana [Residential Amana CE9207W \(BOM: PCE9207W\) Dryer Parts](#) Parts Diagram 01 - BULKHEAD/FELT SEAL/CYL ROLLER & TERM BLK

[Click on the part number to view part](#)

Item	Original Part Number	Replaced By	Status	Part Description
1	500356W	502614WP		Bulkhead, Rear
2	501285			Screw, No.12 X 9/16-Pla
3	61923P	61923		Block, Terminal
4	Y00000000		Not Available	SEE NOTE GROUND WIRE, GREEN -- (SEE NOTE)
5	Y61199	3400094		Screw, 10-32 X 3/8
6	Y00000000		Not Available	SEE NOTE HEATER BOX ASSEMBLY
7	501668	503688		Screw, 10B-16 X .34 I
8	20530			Screw, 10-24 x 3/8 Hex
9	51474		Not Available	WASHER, 13/64IDX1/2ODX.
10	Y00000000		Not Available	SEE NOTE CABINET
11	502120	489069		Xxscrew, 10-12 X 1/2
12	500062	40113601		Assembly, Roller Brkt
13	501668	503688		Screw, 10B-16 X .34 I

14	52549	Washer, 501 ID X3/4 Odx	
15	23748	Ring, Retaining	
16	500214	37001042	Assembly, Cylinder Roller
17	56461	Shaft	
18	56156	358160	Nut
19	501801	37001132	Seal, Cylinder
20	22506P	511637P	Adh Dow 737 Clr 3 Oz Tube

