

Amana DA6120 15 - DRAIN

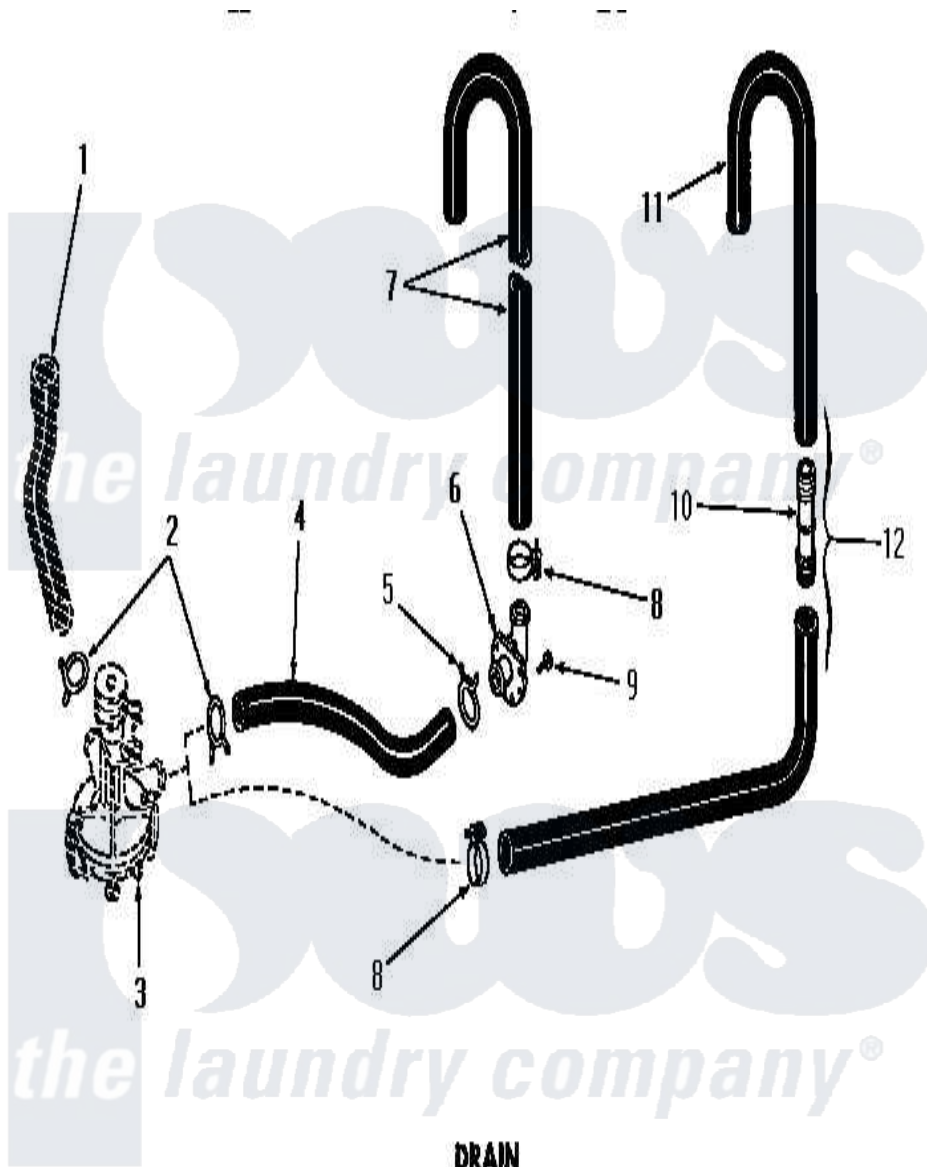

DRAIN (Non Suds-Water Saver Models)

Amana [Residential Amana DA6120 Washer Parts](#) Parts Diagram 15 - DRAIN
Click on the part number to view part

| Item | Original Part Number | Replaced By | Status | Part Description |
|------|-----------------------|------------------------|---------------|---|
| 1 | Y00000000 | | Not Available | SEE NOTE DRAIN TUB OUTLET HOSE |
| 2 | 20210 | | Not Available | NO LONGER AVAILABLE |
| 3 | Y00000000 | | Not Available | SEE NOTE PUMP ASSEMBLY |
| 4 | 21254 | | | Hose |
| 5 | Y03698 | | Not Available | CLAMP xREPLACE |
| 6 | 23553 | | Not Available | ELBOW,DRAIN HOSE-PLAST |
| 7 | 20240 | | | Hose, M/F 29219 |
| 8 | 20211 | 285655 | | Clamp, Hose |
| 9 | 51784 | | Not Available | SCREW,10B-16 X 1/2 HEX |
| 10 | 25863 | 16272 | | Connector, Straight |
| 11 | 25182 | | Not Available | DRAIN HOSE |
| 12 | Y00000000 | | Not Available | SEE NOTE DRAIN HOSE AND HOSE COUPLING -- (SEE NOTE) |