

Amana DA6123 10 - BOOT, CHASSIS & DRAIN TUB

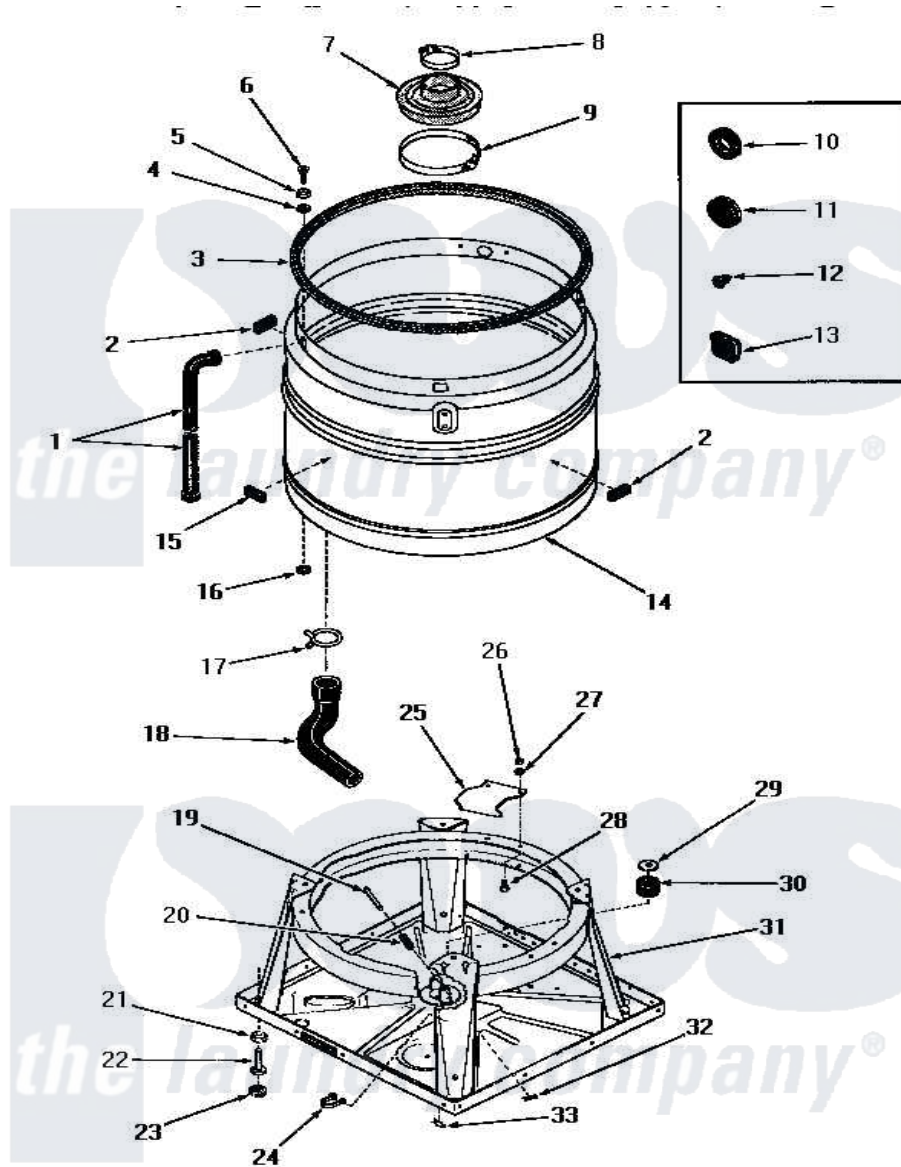

BOOT, CHASSIS AND DRAIN TUB

Amana [Residential Amana DA6123 Washer Parts](#) Parts Diagram 10 - BOOT, CHASSIS & DRAIN TUB
 Click on the part number to view part

Item	Original Part Number	Replaced By	Status	Part Description
1	22818		Not Available	HOSE
2	23258			Pad, Bumper
3	21233		Not Available	GASKET
4	20112			Grommet
5	20111			Washer
6	20259		Not Available	SCREW
7	20129		Not Available	BOOT
8	20107			Upper Clamp
9	20108	F200201		Clamp Hose #56
10	20118		Not Available	GROMMET,1982 INV
11	20305	20-305		Sizzle Do Not Ship Ups
12	21393	21-393		Piezo Sounder
13	21651			Grommet
14	25983			Drain Tub, Shur-Fil
15	23257		Not Available	PAD,BUMPER
16	20115			Grommet

17	10180		Not Available	CLAMP
18	25112			Hose
19	Y22693		Not Available	HOLD-DOWN PIN
20	Y22690		Not Available	FERRULE
21	Y21899	40038101		Nut, Leg
22	20409	22003428		Leg, Adjustable
23	21749	40016001		Foot, Rubber
24	22837		Not Available	STRAP,WIRE
25	21905			Plate, Snubber
26	20275	27001225		Nut, Jam Mid Lock 1/4-20
27	03189			LoCkwasher, 1/4 Std-C P
28	02422			Screw, 1/4-20 X 1/2 HeX
29	20162		Not Available	SPACER
30	20195		Not Available	GROMMET
31	26028			Assembly, Chassis xReplace
32	Y22689		Not Available	PIN CLIP
33	26012	2-6012		Blower Wheel

