

# Amana DA6191 09 - BOOT, CHASSIS & DRAIN TUB

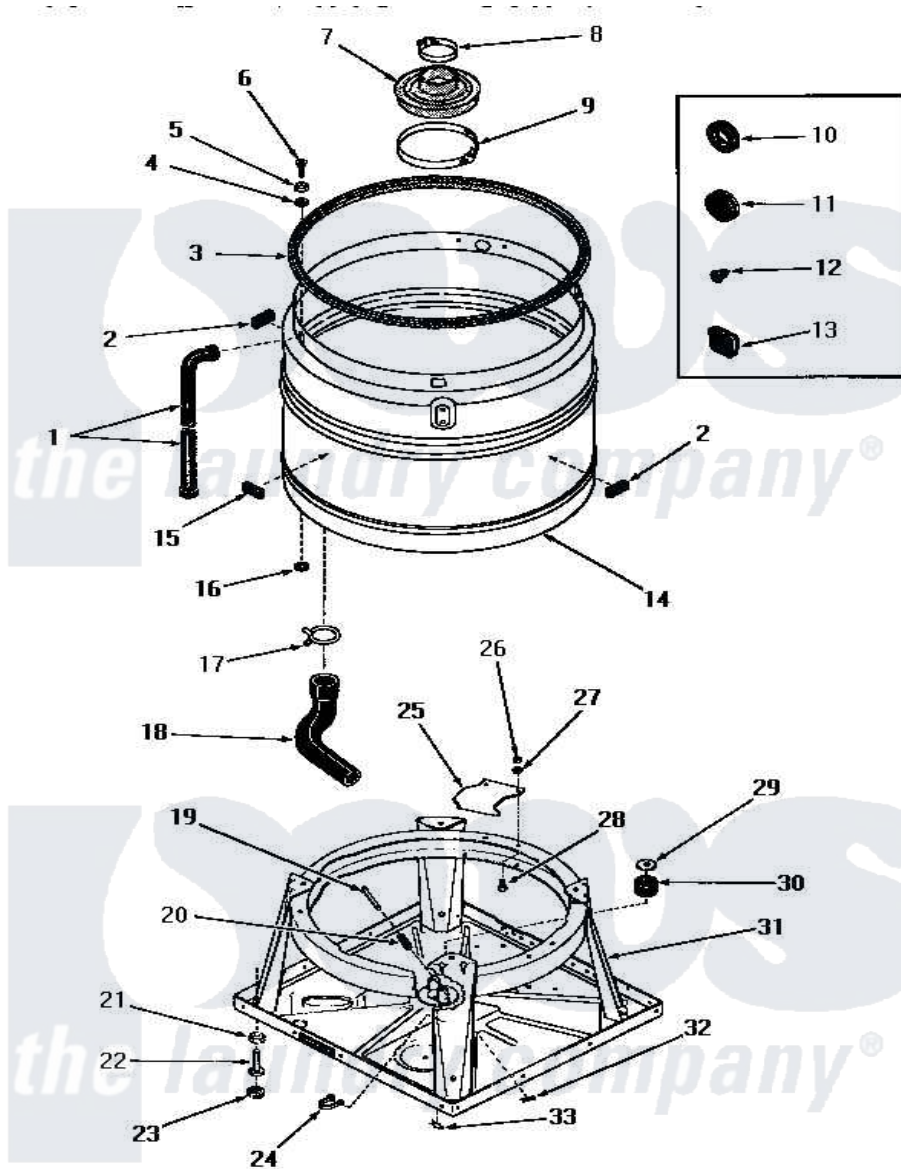

## BOOT, CHASSIS AND DRAIN TUB

Amana [Residential Amana DA6191 Washer Parts](#) Parts Diagram 09 - BOOT, CHASSIS & DRAIN TUB  
 Click on the part number to view part

Item	Original Part Number	Replaced By	Status	Part Description
1	22818		Not Available	HOSE
2	<a href="#">23258</a>			Pad, Bumper
3	21233		Not Available	GASKET
4	<a href="#">20112</a>			Grommet
5	<a href="#">20111</a>			Washer
6	20259		Not Available	SCREW
7	20129		Not Available	BOOT
8	<a href="#">20107</a>			Upper Clamp
9	20108	<a href="#">F200201</a>		Clamp Hose #56
10	20118		Not Available	GROMMET,1982 INV
11	20305	<a href="#">20-305</a>		Sizzle Do Not Ship Ups
12	21393	<a href="#">21-393</a>		Piezo Sounder
13	<a href="#">21651</a>			Grommet
14	<a href="#">25983</a>			Drain Tub, Shur-Fil
15	23257		Not Available	PAD,BUMPER
16	<a href="#">20115</a>			Grommet

17	10180		Not Available	CLAMP
18	<a href="#">25112</a>			Hose
19	Y22693		Not Available	HOLD-DOWN PIN
20	Y22690		Not Available	FERRULE
21	Y21899	<a href="#">40038101</a>		Nut, Leg
22	20409	<a href="#">22003428</a>		Leg, Adjustable
23	21749	<a href="#">40016001</a>		Foot, Rubber
24	22837		Not Available	STRAP,WIRE
25	<a href="#">21905</a>			Plate, Snubber
26	20275	<a href="#">27001225</a>		Nut, Jam Mid Lock 1/4-20
27	<a href="#">03189</a>			LoCkwasher, 1/4 Std-C P
28	<a href="#">02422</a>			Screw, 1/4-20 X 1/2 HeX
29	20162		Not Available	SPACER
30	20195		Not Available	GROMMET
31	<a href="#">26028</a>			Assembly, Chassis xReplace
32	Y22689		Not Available	PIN CLIP
33	26012	<a href="#">2-6012</a>		Blower Wheel

