

Amana DA6251 11 - COUNTERBALANCE WEIGHT, BRKT & MTG PLATE

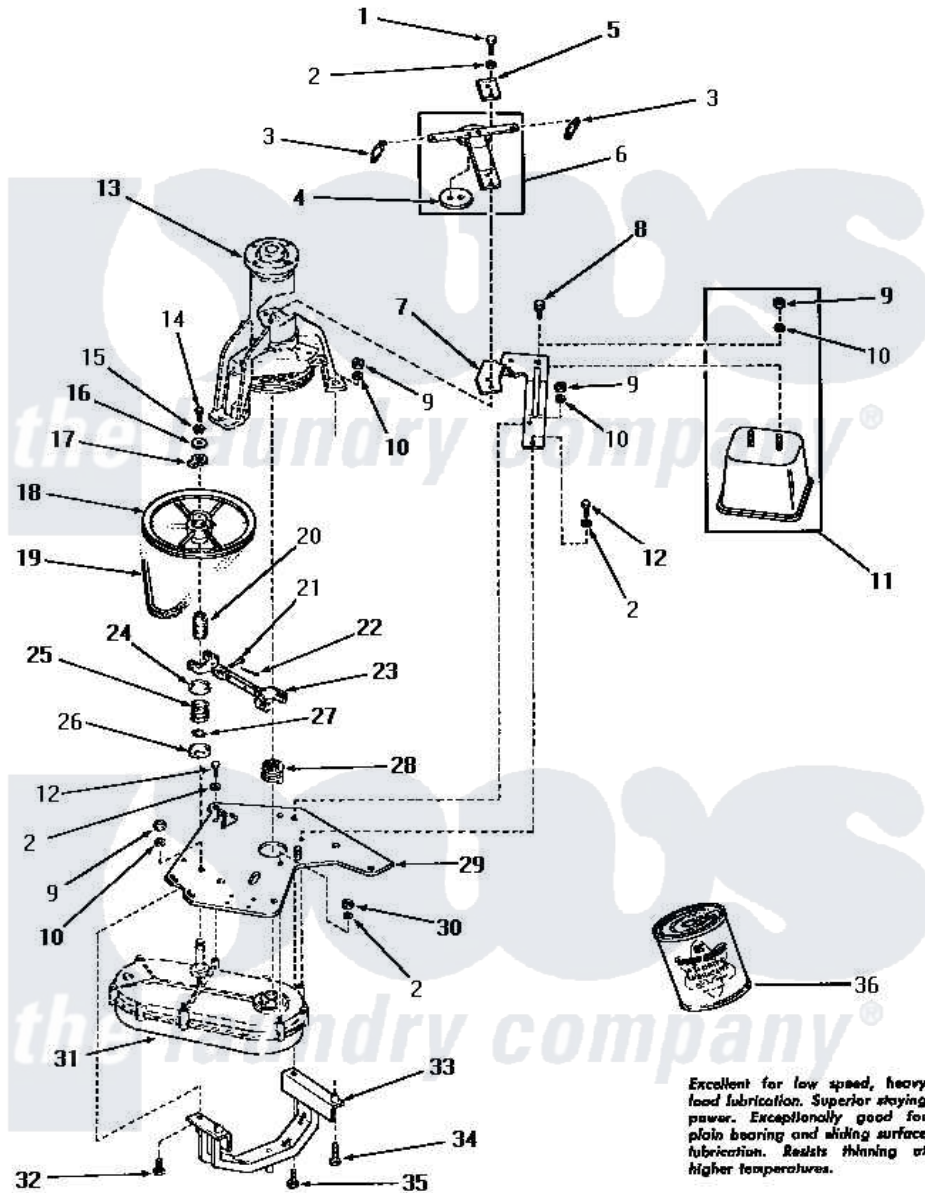

Amana Residential Amana DA6251 Washer Parts Parts Diagram 11 - COUNTERBALANCE WEIGHT, BRKT & MTG PLATE

Click on the part number to view part

Item	Original Part Number	Replaced By	Status	Part Description
1	24233		Not Available	SCREW,CAP-1/4-20 X 3/4
2	03189			LoCkwasher, 1/4 Std-C P
3	23632			Spring
4	20453		Not Available	DISC,FRICTION
5	22614			Plate, Support
6	20168			Assembly, Snubber
7	25139		Not Available	BRACKET
8	23928		Not Available	CAP SCREW AND LOCKWASHER
9	20274	62739		Nut, Lock
10	20277			Lockwasher, 3/8 Std X 3
11	25230		Not Available	COUNTERBALANCE WEIGHT
12	20264			Screw, 1/4-20 X 2 HeX H
13	Y00000000		Not Available	SEE NOTE MAIN BEARING
14	02422			Screw, 1/4-20 X 1/2 HeX
15	02431			Lockwasher, 1/4 Ext Shk

16	23716	Not Available	WASHER
17	23643		Pulley Stop
18	23773	Not Available	ASSY,PULLEY-TRANSMISSI
19	23758		Belt
20	23644		Hub
21	23718	Not Available	PIN,SHIFTER
22	20248		Pin, Cotter
23	23732		Assembly, Shifter Fork
24	26610		Retainer, Spring-Upper
25	26609		Spring
26	26611	Not Available	RETAINER,SPRING-LOWER
27	23751		Ring, Retaining
28	23647		Jaw
29	24749	Not Available	MOUNTING PLATE
30	20275	27001225	Nut, Jam Mid Lock 1/4-20
31	Y00000000	Not Available	SEE NOTE TRANSMISSION ASSEMBLY
32	22687	Not Available	SCREW
33	22702	Not Available	ASSY,YOKE & SLEEVE
34	Y22688	Not Available	SCREW,CAP-3/8-16X1-1/4
35	20255	Not Available	SCREW,3/8-16 X 1 HEX H
NI	03200		A-D Drive Lubricant
"	285P3	23911	Kit Spring

