

Amana DA9011 25 - TRANSMISSION ASSY

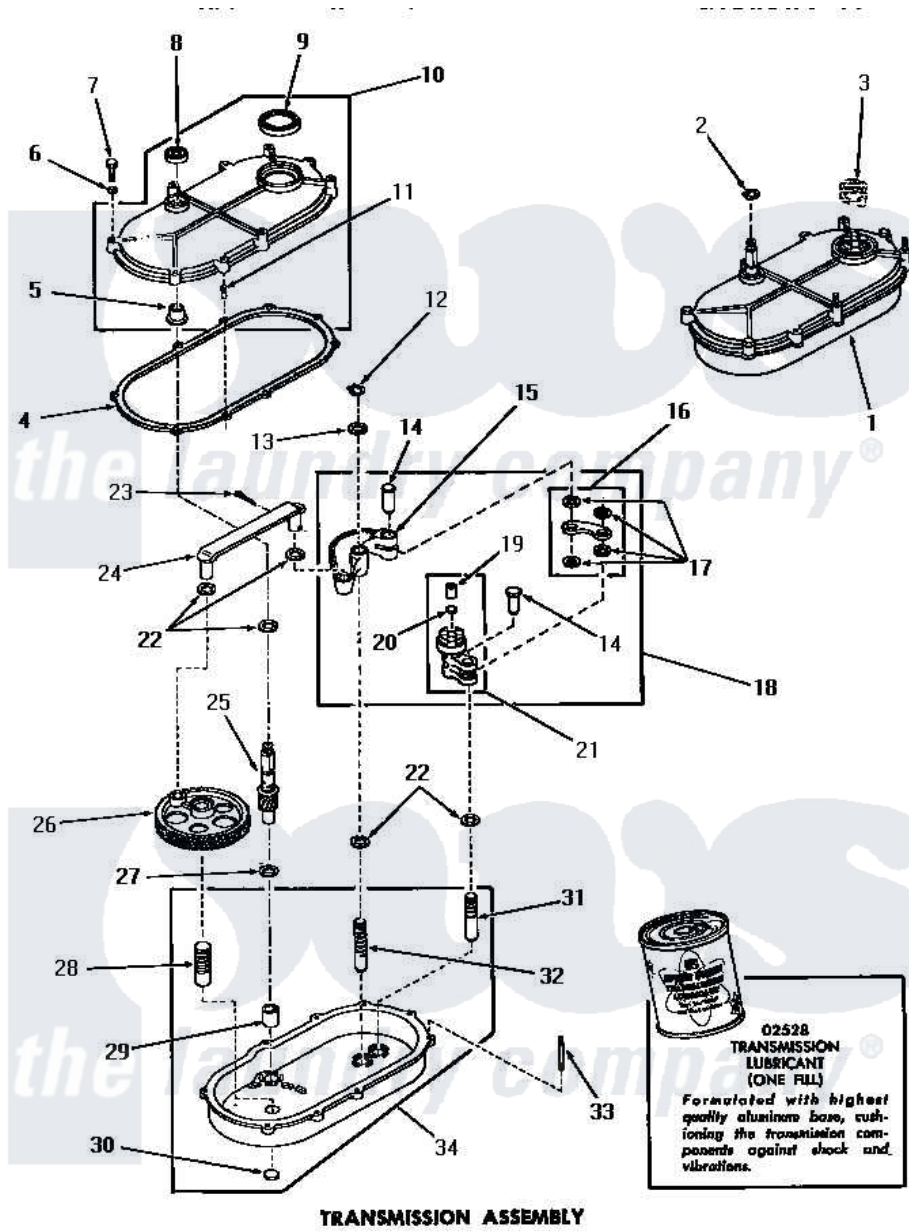

TRANSMISSION ASSEMBLY

Amana [Residential Amana DA9011 Washer Parts](#) Parts Diagram 25 - TRANSMISSION ASSY
 Click on the part number to view part

Item	Original Part Number	Replaced By	Status	Part Description
1	23828			Assembly, Transmission
2	23751			Ring, Retaining
3	Y00000000		Not Available	SEE NOTE SHIFT CLUTCH
4	20059			Gasket
5	20082			Bearing
6	03189			LoCkwasher, 1/4 Std-C P
7	20257		Not Available	SCREW, 1/4-20 X 1-1/4 H
8	20200			Seal
9	20199			Seal
10	20216		Not Available	ASSY, TRANSMISSION COVE
11	20197		Not Available	DOWEL PIN
12	23751			Ring, Retaining
13	20212	35092		Washer, 3628id X 1.00 X .056
14	01690			Pin, Link
15	05005	05005P		Assembly
16	Y04999		Not Available	LINK

17	20212	35092	Washer, 3628id X 1.00 X .056
18	20220		Assembly, Rocker Arm
19	01711	Not Available	BEARING
20	Y02479		Disc, Expansion
21	20219	30927P	Assembly Clutch Arm
22	01791		Washer, .626 X 1.125 X1
23	02578		Pin, Cotter
24	03969	03969P	Rod Connecting
25	23645		Pinion
26	02175	Not Available	GEAR,CRANK
27	20198	41813	Csa 20198 20 4w 19 Deg Cc
28	03477	Not Available	PIN
29	01993		Bearing, 7/8odx5/8id
30	Y02769		Disc
31	01688	Not Available	PIN
32	24817	Not Available	PIN,ROCKER ARM
33	20155	Not Available	STUD,DOUBLE END 1/4-20
34	23927	Not Available	ASSY,TRANSMISSION xREPLACE
NI	02528	02528P	Grease Transmission Mobil 209

