

Amana DE6081 19 - WIRE & TERMINALS

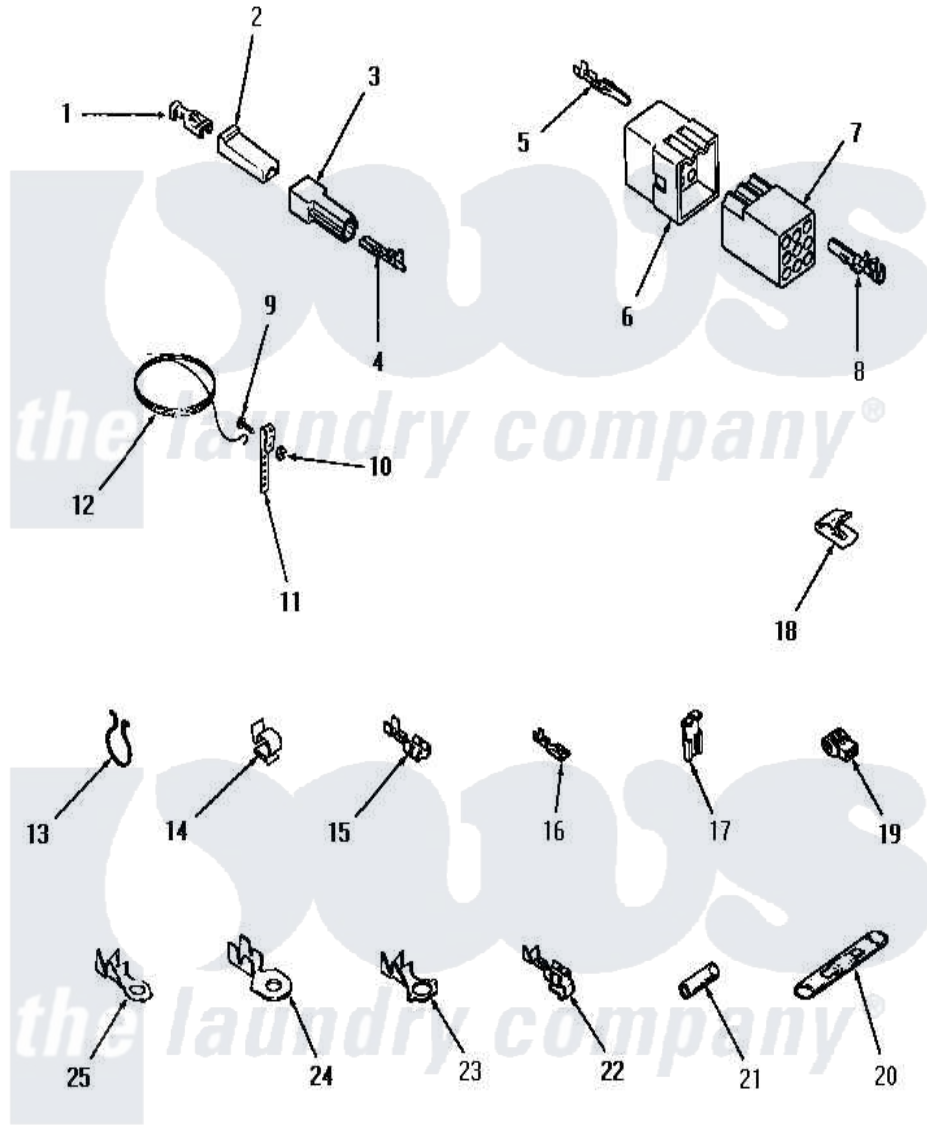

WIRE AND TERMINALS

Amana [Residential Amana DE6081 Washer Parts](#) Parts Diagram 19 - WIRE & TERMINALS
 Click on the part number to view part

Item	Original Part Number	Replaced By	Status	Part Description
1	Y00115			Lock In Spade Terminal (18 Gaug (1/4 Inch-(1) 18 Gauge Wire)
2	90789			Connector
3	90788		Not Available	HOUSING,TAB
4	00133			Terminal, Tab-1/4 Male
5	Y00127			Terminal, Pin-1/8 Male
6	54522			Plug, Nylon
7	54523		Not Available	RECEPTACLE,12 CIRCUIT-
8	Y00128			Terminal, Pin-1/8 Femal
9	21431		Not Available	ROUND HEAD SCREW
10	Y20276		Not Available	NUT
11	21430		Not Available	STRAP,GROUND
12	Y21429		Not Available	GROUND WIRE
13	51291			Clip, Wire
14	21036			Clip, Cable
				SPADE TERMINAL(18

15	Y00119		Not Available	GAUGE) (1/4 INCH-(1) 18 GAUGE WIRE)
16	00112			Terminal, Spade-3/16 Fe
17	Y00120			Terminal, Flag-1/4 Fema
18	21312	51291		Clip, Wire
19	70210		Not Available	INSULATOR,BLUE
20	21091		Not Available	CONNECTOR TWO 1/4 INCH MALE
21	Y21365	503670		Sleeve Insulator
22	Y00114			Spade Terminal
23	Y00113		Not Available	TERMINAL,RING-1/4 STUD
24	Y00111			Ring Terminal No.10 No.10 18 Gauge Wires Or
25	00110			No.10 18 Gauge Wire
NI	20680		Not Available	18 GAUGE WIRE
"	20679		Not Available	WIRE, 12 GAUGE

