

# Amana DE6151 02 - 159P3 SIDE EXHAUST DEFLECTOR KIT

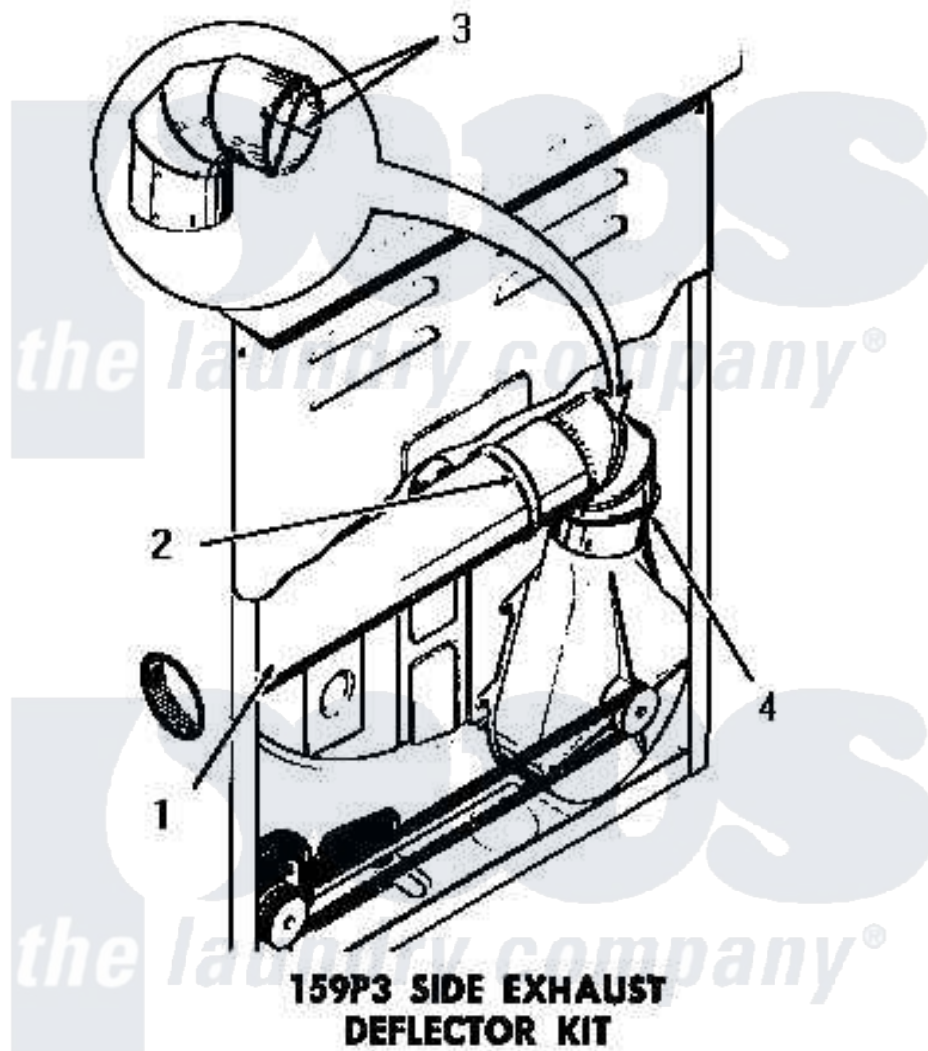

[Amana Residential Amana DE6151 Washer Parts](#) Parts Diagram 02 - 159P3 SIDE EXHAUST DEFLECTOR KIT  
 Click on the part number to view part

Item	Original Part Number	Replaced By	Status	Part Description
1	<a href="#">Y0052776</a>			Handle, Oven Door
2	0052775	<a href="#">0057344</a>		Suptop Burner
3	Y00000000		Not Available	SEE NOTE CUT AND REMOVE WIRE GUARDS
4	Y00000000		Not Available	SEE NOTE DRYER EXHAUST ELBOW -- (SUPPLIED WITH DRYER)
NI	159P3		Not Available	SIDE EXHAUST DEFLECTOR KIT