

# Amana DG3280 23 - WIRE & TERMINALS

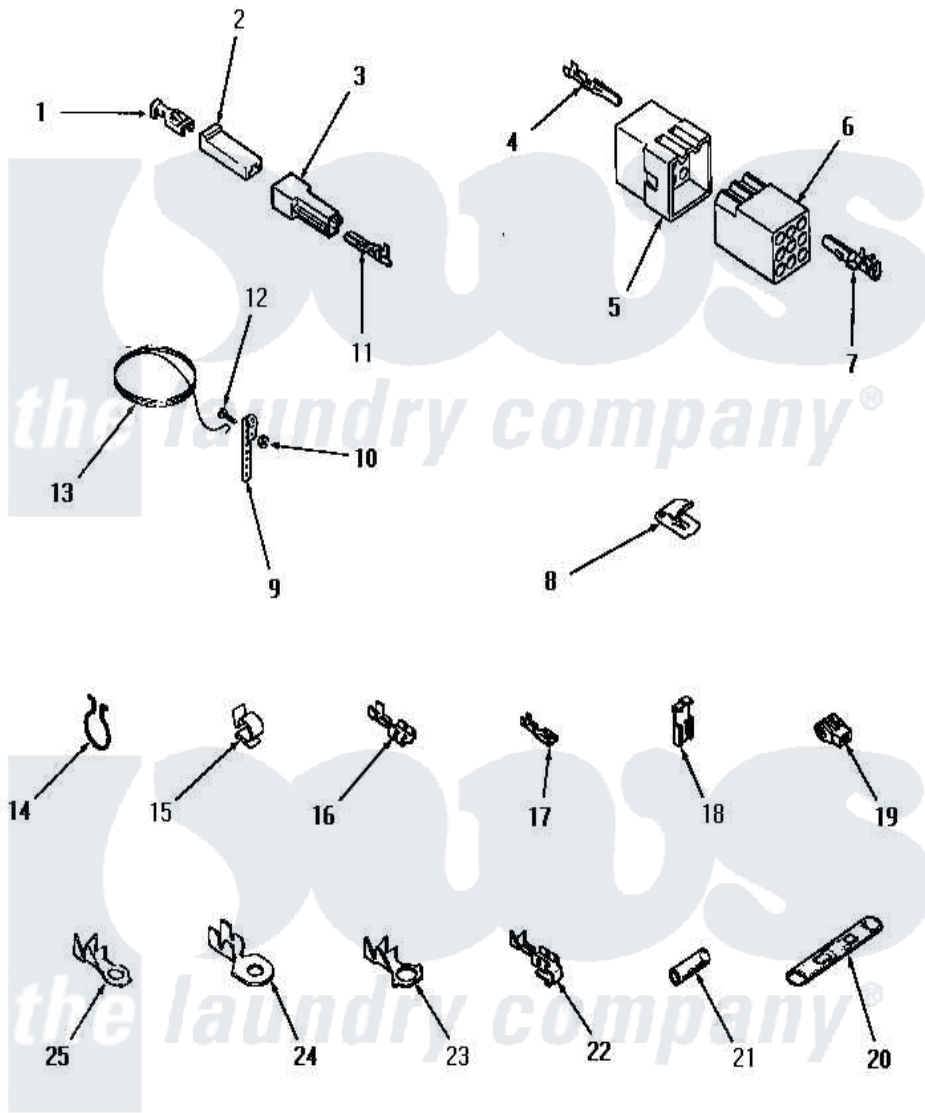

## WIRE AND TERMINALS

Amana [Residential Amana DG3280 Washer Parts](#) Parts Diagram 23 - WIRE & TERMINALS  
 Click on the part number to view part

Item	Original Part Number	Replaced By	Status	Part Description
1	<a href="#">Y00115</a>			Lock In Spade Terminal (18 Gaug (1/4 Inch-(1) 18 Gauge Wire)
2	<a href="#">90789</a>			Connector
3	90788		Not Available	HOUSING, TAB
4	<a href="#">Y00116</a>			Terminal, Pin-Male
5	<a href="#">23033</a>			Plug, 9 Circuit
6	<a href="#">26163</a>			Receptacle, 9 Circuit
7	Y00117	<a href="#">5011-XX</a>		093 Female Socket
8	<a href="#">20309</a>			Cable Clip
9	21430		Not Available	STRAP, GROUND
10	Y20276		Not Available	NUT
11	<a href="#">00133</a>			Terminal, Tab-1/4 Male
12	21431		Not Available	ROUND HEAD SCREW
13	Y21429		Not Available	GROUND WIRE
14	<a href="#">51291</a>			Clip, Wire
15	<a href="#">21036</a>			Clip, Cable

16	Y00119		Not Available	SPADE TERMINAL(18 GAUGE) (1/4 INCH-(1) 18 GAUGE WIRE)
17	<a href="#">00112</a>			Terminal, Spade-3/16 Fe
18	<a href="#">Y00120</a>			Terminal, Flag-1/4 Fema
19	70210		Not Available	INSULATOR,BLUE
20	21091		Not Available	CONNECTOR TWO 1/4 INCH MALE
21	Y21365	<a href="#">503670</a>		Sleeve Insulator
22	<a href="#">Y00114</a>			Spade Terminal
23	Y00113		Not Available	TERMINAL,RING-1/4 STUD
24	<a href="#">Y00111</a>			Ring Terminal No.10 No.10 18 Gauge Wires Or
25	<a href="#">00110</a>			No.10 18 Gauge Wire
NI	20680		Not Available	18 GAUGE WIRE
"	20679		Not Available	WIRE, 12 GAUGE

